

» GYNÄKOLOGIE UND GEBURTSHILFE

» GYNECOLOGY AND OBSTETRIC

» GYNÉCOLOGIE ET OBSTÉTRIQU

» GINECOLOGÍA Y OBSTÉTRICI

» GINEGOLOGIA E OSTETRICI



Scheidenspekula
Vaginal specula

Spéculums vaginaux
Especulos vaginales
Specoli vaginali



Scheidenspekula mit Absaugung auf Anfrage lieferbar.
Specula with aspiration are available upon request.
Spéculums avec aspiration sont disponibles sur demande.
Especulos con aspiración son disponibles según demanda.
A richiesta gli specoli sono fornibili anche con tubo d'aspirazione.



CUSCO

75 mm x 32 mm	18-101-001
85 mm x 35 mm	18-101-002
100 mm x 35 mm	18-101-003



CUSCO

75 mm x 32 mm	18-102-001
85 mm x 35 mm	18-102-002
100 mm x 37 mm	18-102-003

175 mm x 17 mm	18-103-000
----------------	------------

für Jungfrauen
for virgins
pour vierges
para vírgenes
per vergine

Scheidenspekula
Vaginal specula

Spéculums vaginaux
Espéculos vaginales
Specoli vaginali



Scheidenspekula mit Absaugung auf Anfrage lieferbar.
Specula with aspiration are available upon request.
Spéculums avec aspiration sont disponibles sur demande.
Espéculos con aspiración son disponibles según demanda.
A richiesta gli specoli sono fornibili anche con tubo d'aspirazione.



CUSCO

90 mm x 23 mm	18-104-001
100 mm x 25 mm	18-104-002
105 mm x 27 mm	18-104-003

Schweizer Modell
Swiss pattern
Modèle suisse
Modelo suizo
Modello svizzero



GRAVE

75 mm x 20 mm	18-105-001
95 mm x 35 mm	18-105-002
115 mm x 35 mm	18-105-003

Scheidenspekula *Vaginal specula*

Spéculums vaginaux
Espéculos vaginales
Specoli vaginali



Scheidenspekula mit Absaugung auf Anfrage lieferbar.
Specula with aspiration are available upon request.
Spéculums avec aspiration sont disponibles sur demande.
Espéculos con aspiración son disponibles según demanda.
A richiesta gli specoli sono fornibili anche con tubo d'aspirazione.



SEMM

90 mm x 14 / 18 mm	18-106-000
100 mm x 17 / 20 mm	18-106-001
100 mm x 25 / 30 mm	18-106-002



COLLIN

90 mm x 16 mm	18-107-000
90 mm x 28 mm	18-107-001
100 mm x 35 mm	18-107-002
110 mm x 40 mm	18-107-003



TRELA T

85 mm x 33 mm	18-108-010
95 mm x 35 mm	18-108-020
115 mm x 43 mm	18-108-030



PEDERSON

75 mm x 13 mm	18-109-010
100 mm x 22 mm	18-109-020
120 mm x 25 mm	18-109-030

Scheidenspekula
Vaginal specula

Spéculums vaginaux
Espéculos vaginales
Specoli vaginali



KRISTELLER

70 mm x 27 mm	18-110-001
80 mm x 30 mm	18-110-002
90 mm x 36 mm	18-110-003
110 mm x 27 mm	18-111-010
110 mm x 30 mm	18-111-020
110 mm x 36 mm	18-111-030

Spekulum
Speculum
Spéculum
Espéculo
Specolo

75 mm x 23 mm	18-112-001
85 mm x 26 mm	18-112-002
100 mm x 32 mm	18-112-003
115 mm x 23 mm	18-113-010
115 mm x 26 mm	18-113-020
115 mm x 32 mm	18-113-030

Halter
Retractor
Valve
Valva
Valve

18-114-001
18-114-002
18-114-003
18-115-010
18-115-020
18-115-030

Satz
Set
Jeu
Juego
Serie

Scheidenspekula *Vaginal specula*

Spéculums vaginaux
Espéculos vaginales
Specoli vaginali



KRISTELLER

105 mm x 18 mm	18-116-010
105 mm x 21 mm	18-116-020

Spekulum konisch, für Jungfrauen
Speculum tapered, for virgins
Spéculum conique, pour vierges
Espéculo cónico, para vírgenes
Specolo conico, per virgini

110 mm x 14 mm	18-117-010
115 mm x 17 mm	18-117-020

Halter
Retractor
Valve
Valva
Valve

18-118-010
18-118-020

Satz
Set
Jeu
Juego
Serie

Scheidenspekula
Vaginal specula

Spéculum vaginaux
Espéculos vaginales
Specoli vaginali

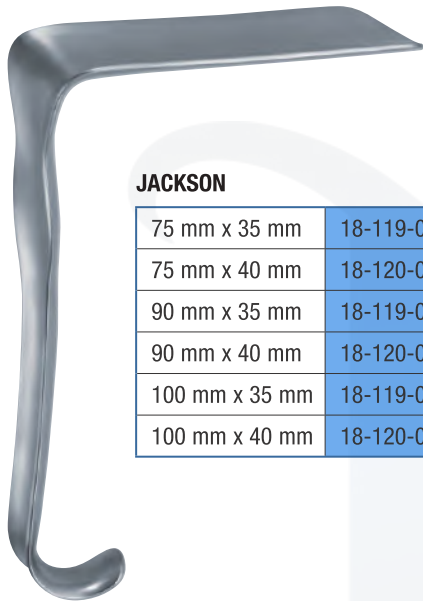

JACKSON

75 mm x 35 mm	18-119-010
75 mm x 40 mm	18-120-010
90 mm x 35 mm	18-119-020
90 mm x 40 mm	18-120-020
100 mm x 35 mm	18-119-030
100 mm x 40 mm	18-120-030



AUVARD

220 mm – 8 ¼ "
80 mm x 38 mm
18-121-220



60 mm x 25 mm / 30 mm	70 mm x 30 mm / 35 mm	80 mm x 35 mm / 40 mm
18-122-001	18-122-002	18-122-003

SIMS

18-123-000	x	x	x
------------	---	---	---

Satz
Set
Jeu
Juego
Serie

Scheidenspekula
Vaginal specula

Spéculums vaginaux
Espéculos vaginales
Specoli vaginali



KALLMORGEN

70 mm x 40 mm	18-124-010
90 mm x 40 mm	18-124-020

Spekulum
Speculum
Spéculum
Espéculo
Specolo

70 mm x 33 mm	18-125-010
90 mm x 33 mm	18-125-020

Halter
Retractor
Valve
Valva
Valve

18-126-010
18-126-020

Satz
Set
Jeu
Juego
Serie

Scheidenspekula
Vaginal specula

Spéculums vaginaux
Espéculos vaginales
Specoli vaginali



LANDAU

	290 mm – 11 ½ "
100 mm x 28 mm	18-127-280
100 mm x 38 mm	18-127-380

Scheidenspekula
Vaginal specula

Spéculums vaginaux
Espéculos vaginales
Specoli vaginali



BREISKY

	300 mm – 12 "
130 mm x 10 mm	18-128-010
130 mm x 15 mm	18-128-015
130 mm x 20 mm	18-128-020
130 mm x 25 mm	18-128-025
130 mm x 30 mm	18-128-030
130 mm x 35 mm	18-128-035
130 mm x 40 mm	18-128-040

Wiener Modell
Vienna pattern
Modèle Vienne
Modelo Vienna
Modello Vienna

	300 mm – 12 "
100 mm x 10 mm	18-129-010
100 mm x 15 mm	18-129-015
100 mm x 20 mm	18-129-020
100 mm x 25 mm	18-129-025
100 mm x 30 mm	18-129-030
100 mm x 35 mm	18-129-035
100 mm x 40 mm	18-129-040
115 mm x 10 mm	18-130-010
115 mm x 15 mm	18-130-015
115 mm x 20 mm	18-130-020
115 mm x 25 mm	18-130-025
115 mm x 30 mm	18-130-030
115 mm x 35 mm	18-130-035
115 mm x 40 mm	18-130-040

	350 mm – 13 ¾ "
160 mm x 20 mm	18-131-020
160 mm x 25 mm	18-131-025
160 mm x 30 mm	18-131-030
160 mm x 35 mm	18-131-035
160 mm x 40 mm	18-131-040
180 mm x 20 mm	18-132-020
180 mm x 25 mm	18-132-025
180 mm x 30 mm	18-132-030
180 mm x 35 mm	18-132-035
180 mm x 40 mm	18-132-040

Scheidenspekula Vaginal specula

Spéculums vaginaux
Espéculos vaginales
Specoli vaginali



Fig. 1	Fig. 2	Fig. 3	Fig. 4	Fig. 5
80 mm x 30 mm	85 mm x 35 mm	90 mm x 40 mm	55 mm x 40 mm / 60 mm	70 mm x 45 mm / 70 mm
18-133-001	18-133-002	18-133-003	18-133-004	18-133-005

SCHERBACK

18-133-000

Satz mit 400 g Gewicht 432-298-100
Set with weight 400 grs. 432-298-100
Jeu avec poids 400 gr. 432-298-100
Juego con peso 400 gr. 432-298-100
Serie con peso di 400 gr. 432-298-100



400 g	18-134-400
600 g	18-134-600
800 g	18-134-800



18-141-000

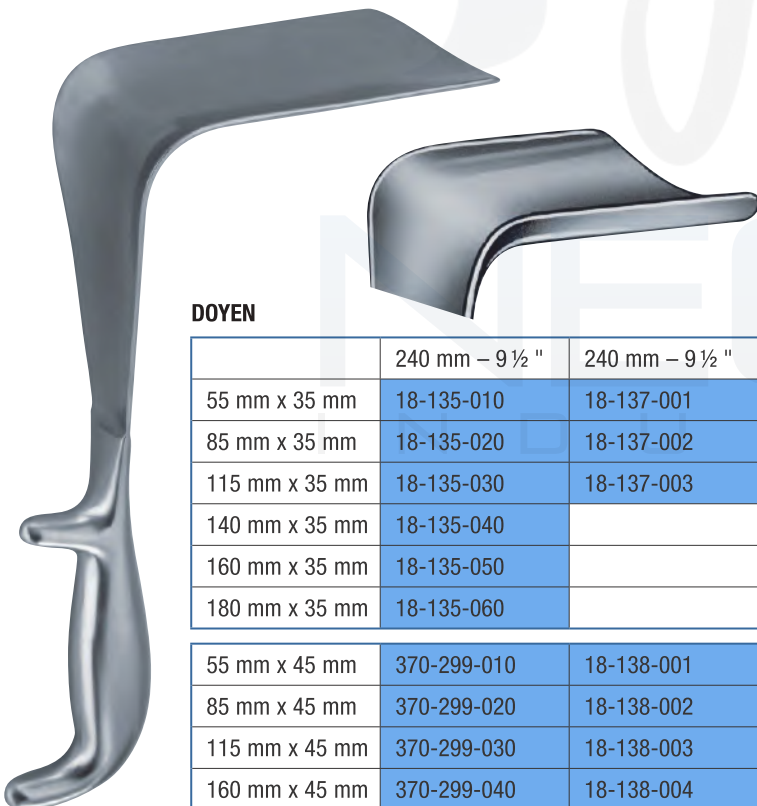

DOYEN

	240 mm – 9 ½ "	240 mm – 9 ½ "
55 mm x 35 mm	18-135-010	18-137-001
85 mm x 35 mm	18-135-020	18-137-002
115 mm x 35 mm	18-135-030	18-137-003
140 mm x 35 mm	18-135-040	
160 mm x 35 mm	18-135-050	
180 mm x 35 mm	18-135-060	
55 mm x 45 mm	370-299-010	18-138-001
85 mm x 45 mm	370-299-020	18-138-002
115 mm x 45 mm	370-299-030	18-138-003
160 mm x 45 mm	370-299-040	18-138-004
180 mm x 45 mm	370-299-050	

55 mm x 60 mm	18-139-010	18-140-001
85 mm x 60 mm	18-139-020	18-140-002
115 mm x 60 mm	18-139-030	18-140-003
160 mm x 60 mm	18-139-040	
180 mm x 60 mm	18-139-050	

leicht hohl
slightly concave
légèrement concave
ligeramente concava
legermente concavo

halbhohl
medium concave
semi concave
semi concava
semi concavo

endospekula
Endospecula
Endospéculums
Endospéculos
Endospecoli

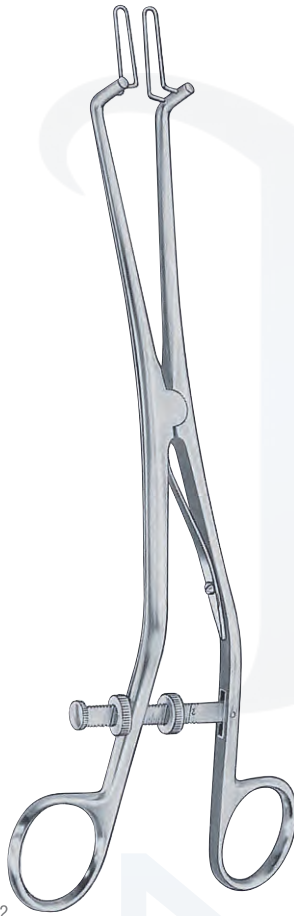

1:2

KOGAN

240 mm – 9 ½"

18-142-240

mit Skalensperre und Stellschraube
 with scale-ratchet and fixation screw
 avec crémaillère à échelle et vis à fixation
 con cremallera graduada y tornillo fijación
 con cremagliera graduata e vite di fissaggio



1:2

KOGAN

240 mm – 9 ½"

18-143-240



1:2

KOGAN-MODIF.

	280 mm – 11"
x = 2 mm y = 4 mm	18-144-240
x = 4 mm y = 8 mm	18-144-480

Parametriumklemmen
Parametrium forceps

Pinces parametrium
Pinzas parametrium
Pinze parametrium



210 mm – 8 ¼"	13-913-210	18-145-210	18-146-210	18-147-210	18-148-210
240 mm – 9 ½"	13-913-240	18-145-240	18-146-240	18-147-240	18-148-240
260 mm – 10 ¼"	13-913-260	18-145-260	18-146-260	18-147-260	18-148-260
300 mm – 12"	13-913-300	18-145-300	18-146-300	18-147-300	18-148-300
350 mm – 13 ¾"	13-913-350	18-145-350	18-146-350	18-147-350	18-148-350

S-förmig gebogen
S-curved
coube en S
curva en S
curva a forma di S

hysterektomieklemmen
Hysterectomy forceps

Pinces à hystérectomie
Pinzas-clamps para histerectomía
Pinze per isterectomia

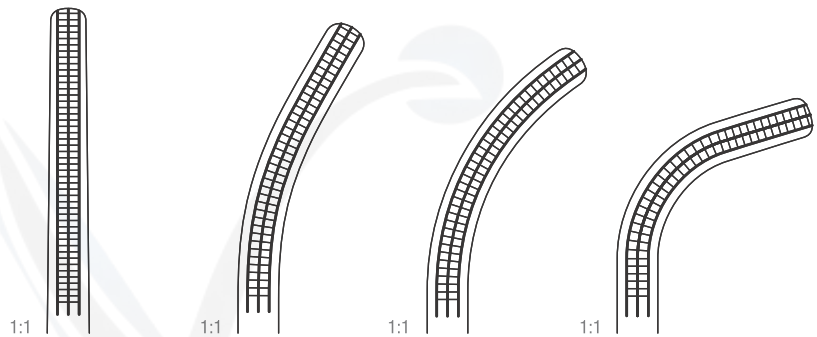

ROGERS

Atrauma	Atrauma	Atrauma	Atrauma
Fig. 1	Fig. 2	Fig. 3	Fig. 4
220 mm – 8 ¾ "	215 mm – 8 ½ "	210 mm – 8 ¼ "	205 mm – 8 "
18-149-100	18-149-200	18-149-300	18-149-400

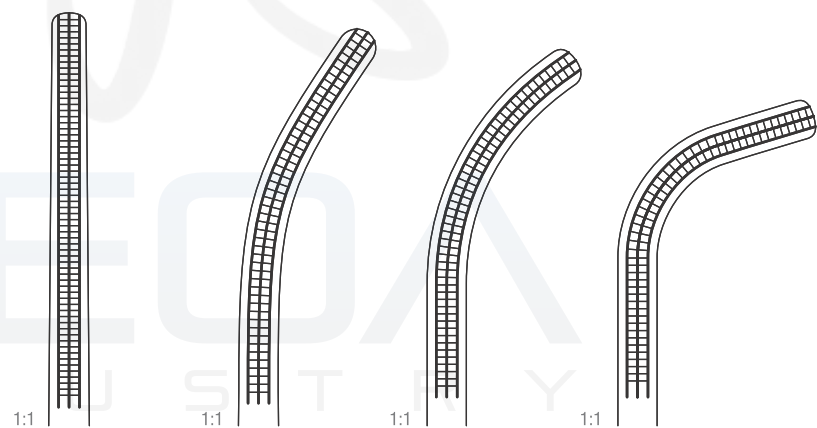

Atrauma	Atrauma	Atrauma	Atrauma
Fig. 1	Fig. 2	Fig. 3	Fig. 4
250 mm – 9 ¾ "	250 mm – 9 ¾ "	245 mm – 9 ¾ "	230 mm – 9 "
18-150-100	18-150-200	18-150-300	18-150-400

uterus-Sonden
Uterine sounds

Hystéromètres du col de l'utérus
Histerómetros uterinos
Isterometri uterini



1:2

VALLEIX

250 mm – 9 ¾ "

18-151-250

graduiert, mit Schieber
graduated, with slider
gradué, avec curseur
graduado, con cursor
graduato, con cursore

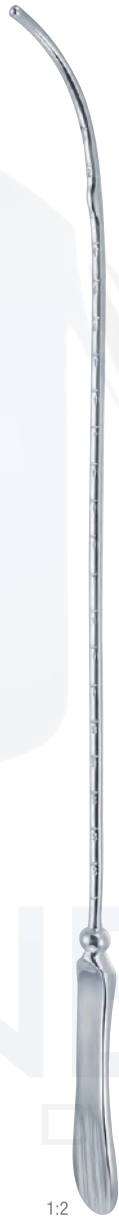

1:2

MARTIN

320 mm – 12 ½ "

18-152-320

18-153-320

fest
rigid
rigide
rígido
rigido

biegsam
malleable
malléable
maleable
malleabile



1:2

SIMS

320 mm – 12 ½ "

18-154-320

18-155-320

fest
rigid
rigide
rígido
rigido

biegsam
malleable
malléable
maleable
malleabile

uterus-dilatatoren
Uterine dilators

Dilatateurs du col de l'utérus
Dilatadores uterinos
Dilatatori uterini



HEGAR

1.0 mm Ø	18-156-001	10.0 mm Ø	18-156-010	20.0 mm Ø	18-156-020
1.5 mm Ø	18-157-015	10.5 mm Ø	18-157-105	21.0 mm Ø	18-156-021
2.0 mm Ø	18-156-002	11.0 mm Ø	18-156-011	22.0 mm Ø	18-156-022
2.5 mm Ø	18-157-025	11.5 mm Ø	18-157-115	23.0 mm Ø	18-156-023
3.0 mm Ø	18-156-003	12.0 mm Ø	18-156-012	24.0 mm Ø	18-156-024
3.5 mm Ø	18-157-035	12.5 mm Ø	18-157-125	25.0 mm Ø	18-156-025
4.0 mm Ø	18-156-004	13.0 mm Ø	18-156-013	26.0 mm Ø	18-156-026
4.5 mm Ø	18-157-045	13.5 mm Ø	18-157-135	27.0 mm Ø	18-156-027
5.0 mm Ø	18-156-005	14.0 mm Ø	18-156-014	28.0 mm Ø	18-156-028
5.5 mm Ø	18-157-055	14.5 mm Ø	18-157-145	29.0 mm Ø	18-156-029
6.0 mm Ø	18-156-006	15.0 mm Ø	18-156-015	30.0 mm Ø	18-156-030
6.5 mm Ø	18-157-065	15.5 mm Ø	18-157-155		
7.0 mm Ø	18-156-007	16.0 mm Ø	18-156-016		
7.5 mm Ø	18-157-075	16.5 mm Ø	18-157-165		
8.0 mm Ø	18-156-008	17.0 mm Ø	18-156-017		
8.5 mm Ø	18-157-085	17.5 mm Ø	18-157-175		
9.0 mm Ø	18-156-009	18.0 mm Ø	18-156-018		
9.5 mm Ø	18-157-095	18.5 mm Ø	18-157-185		
		19.0 mm Ø	18-156-019		
		19.5 mm Ø	18-157-195		

HEGAR

3 mm – 10 mm Ø	8	18-156-500
4 mm – 17 mm Ø	14	18-156-501
1 mm – 26 mm Ø	26	18-156-000
3 mm – 13 mm Ø	10	62-333-313

Stück per Satz
Pieces per set
Pièces per jeu
Piezas para juego
Pezzi per serie

Satz, ohne Metalletui
Set, without metal case
Jeu, sans boîte en métal
Juego, sin caja de metal
Serie, senza astuccio metallico

uterus-dilatatoren
Uterine dilators

Dilatateurs du col de l'utérus
Dilatadores uterinos
Dilatatori uterini

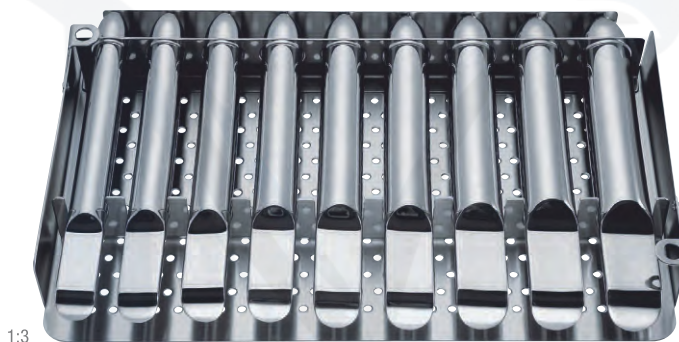

1:3



1:3

4 mm – 17 mm Ø	14	18-158-000
1 mm – 26 mm Ø	26	18-159-000

Stück per Satz
Pieces per set
Pièces per jeu
Piezas para juego
Pezzi per serie

Satz, in Metalletui
Set, in metal case
Jeu, en boîte en métal
Juego, en caja de metal
Serie, con astuccio metallico

uterus-dilatatoren
Uterine dilators

Dilatateurs du col de l'utérus
Dilatadores uterinos
Dilatatori uterini



HEGAR

1/2 mm Ø	18-160-001
3/4 mm Ø	18-160-003
5/6 mm Ø	18-160-005
7/8 mm Ø	18-160-007
9/10 mm Ø	18-160-009
11/12 mm Ø	18-160-011
13/14 mm Ø	18-160-013
15/16 mm Ø	18-160-015
17/18 mm Ø	18-160-017
19/20 mm Ø	18-160-019
21/22 mm Ø	18-160-021
23/24 mm Ø	18-160-023
25/26 mm Ø	18-160-025

HEGAR

3/4 mm – 17/18 mm Ø	8	18-161-080
1/2 mm – 25/26 mm Ø	13	18-161-130

Stück per Satz
Pieces per set
Pièces per jeu
Piezas para juego
Pezzi per serie

Satz, ohne Metalletui
Set, without metal case
Jeu, sans boîte en métal
Juego, sin caja de metal
Serie, senza astuccio metallico



1:3



1:3

HEGAR

3/4 mm – 17/18 mm Ø	8	18-162-002	18-162-000
1/2 mm – 25/26 mm Ø	13		18-163-000

Stück per Satz
Pieces per set
Pièces per jeu
Piezas para juego
Pezzi per serie

Satz in Stoffrolltasche
Set in canvas roll
Jeu en poche de textile
Juego en bolsa de tela
Serie in astuccio di tela

Satz, in Metalletui
Set, in metal case
Jeu, en boîte en métal
Juego, en caja de metal
Serie, con astuccio metallico

uterus-dilatatoren
Uterine dilators

Dilatateurs du col de l'utérus
Dilatadores uterinos
Dilatatori uterini



HANK

Fig. 9 / 10	4.5 / 5.0 mm Ø	18-164-100
Fig. 11 / 12	5.5 / 6.0 mm Ø	18-164-120
Fig. 13 / 14	6.5 / 7.0 mm Ø	18-164-140
Fig. 15 / 16	7.5 / 8.0 mm Ø	18-164-160
Fig. 17 / 18	8.5 / 9.0 mm Ø	18-164-180
Fig. 19 / 20	9.5 / 10.0 mm Ø	18-164-200

HANK

4.5 / 5 mm – 9.5 / 10 mm Ø	6	18-165-060
Stück per Satz Pieces per set Pièces per jeu Piezas para juego Pezzi per serie		Satz, allein Set, only Jeu, seul Juego, sólo Serie, solo



BRAUN 1:3

280 mm – 11 "
18-166-280

1:3

HANK

4.5 / 5 mm – 9.5 / 10 mm Ø	6	18-167-080
Stück per Satz Pieces per set Pièces per jeu Piezas para juego Pezzi per serie		Satz in Stoffrolltasche Set in canvas roll Jeu en poche de textile Juego en bolsa de tela Serie in astuccio di tela



hakenzangen
Tenaculum forceps

Pinces pour l'abaissement du col de l'utérus

Pinzas para coger el cuello del utero

Pinze per abbassare il collo dell'utero



1:2

**STAUDE-
MOORE**

170 mm – 6 ¾ "

18-168-170



1:2

BARRETT

180 mm – 7 "

18-169-180



1:2

SKENE

240 mm – 9 ½ "

18-170-240



1:2

BRAUN

250 mm – 9 ¾ "

18-171-250

hakenzangen
Tenaculum forceps

Pinces pour l'abaissement du col de l'utérus
Pinzas para coger el cuello del utero
Pinze per abbassare il collo dell'utero



POZZI

255 mm – 10 "

18-172-250



SCHROEDER

250 mm – 9 ¾ "

18-173-250



SCHROEDER

240 mm – 9 ½ "



1:2

18-174-240



1:2

18-175-240

hakenzangen
Tenaculum forceps

Pinces pour l'abaissement du col de l'utérus
Pinzas para coger el cuello del utero
Pinze per abbassare il collo dell'utero



DUPLAY 1:2

280 mm – 11 "

18-176-280



IOWA 1:2

260 mm – 10 ¼ "

18-177-260



BEACHAM 1:2

260 mm – 10 ¼ "

18-178-260

Amniotom
Amniotome
Amniotomo
Amniótomo
Amniotomo

hakenzangen
Tenaculum forceps

Pinces pour l'abaissement du col de l'utérus
Pinzas para coger el cuello del utero
Pinze per abbassare il collo dell'utero



MUSEUX

	240 mm – 9 ½ "	240 mm – 9 ½ "
6 mm	18-179-006	18-180-006
8 mm	18-179-008	18-180-008
10 mm	18-179-010	18-180-010



1:2

JACOBS

210 mm – 8 ¼ "	18-181-215	18-182-215
----------------	------------	------------



1:2

TEALE

230 mm – 9 "	18-183-230
--------------	------------

hakenzangen

Tenaculum forceps

Pinces pour l'abaissement du col de l'utérus

Pinzas para coger el cuello del útero

Pinze per abbassare il collo dell'utero



1:2

PRATT

280 mm – 11 "

18-184-280



1:2

CZERNY

205 mm – 8 "

18-185-210

uterus-Polypenzangen
Uterine polypus forceps

Pinces à polypes utérins
Pinzas para pólipos uterinos
Pinze per polipi uterini



uterusfazzangen
Uterine seizing forceps

Pinces hystérolabes
Histerólabos
Pinze isterolabi

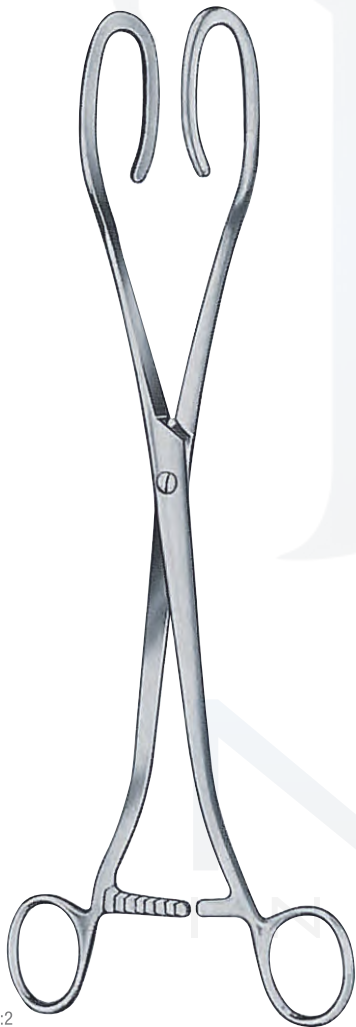

1:2

DARTIGUES

270 mm – 10 ¾" 18-189-270



1:2

SOMER

230 mm – 9" 18-190-230



1:2

COLLIN

250 mm – 9 ¾" 18-191-250

myom-instrumente
Myoma instruments

Instruments pour myomes
Instrumentos para fibroma
Strumenti per miomi

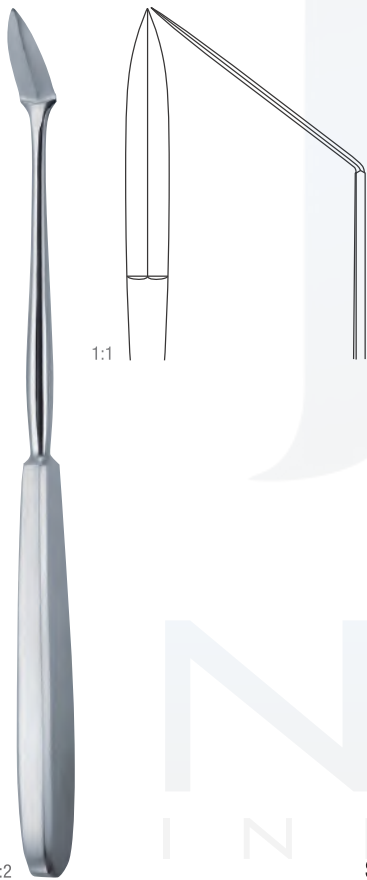

AYRE 1:2

235 mm – 9"

18-192-235

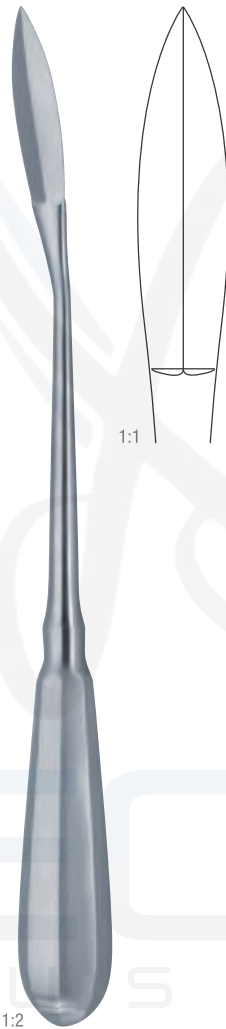

SEGOND 1:2

270 mm – 10 3/4"

18-193-270



DOYEN 1:2

170 mm – 6 3/4"

18-194-170

Fistelhaken
Fistula hooks

Crochets pour fistules
Ganchos para fistulas
Uncini per fistole

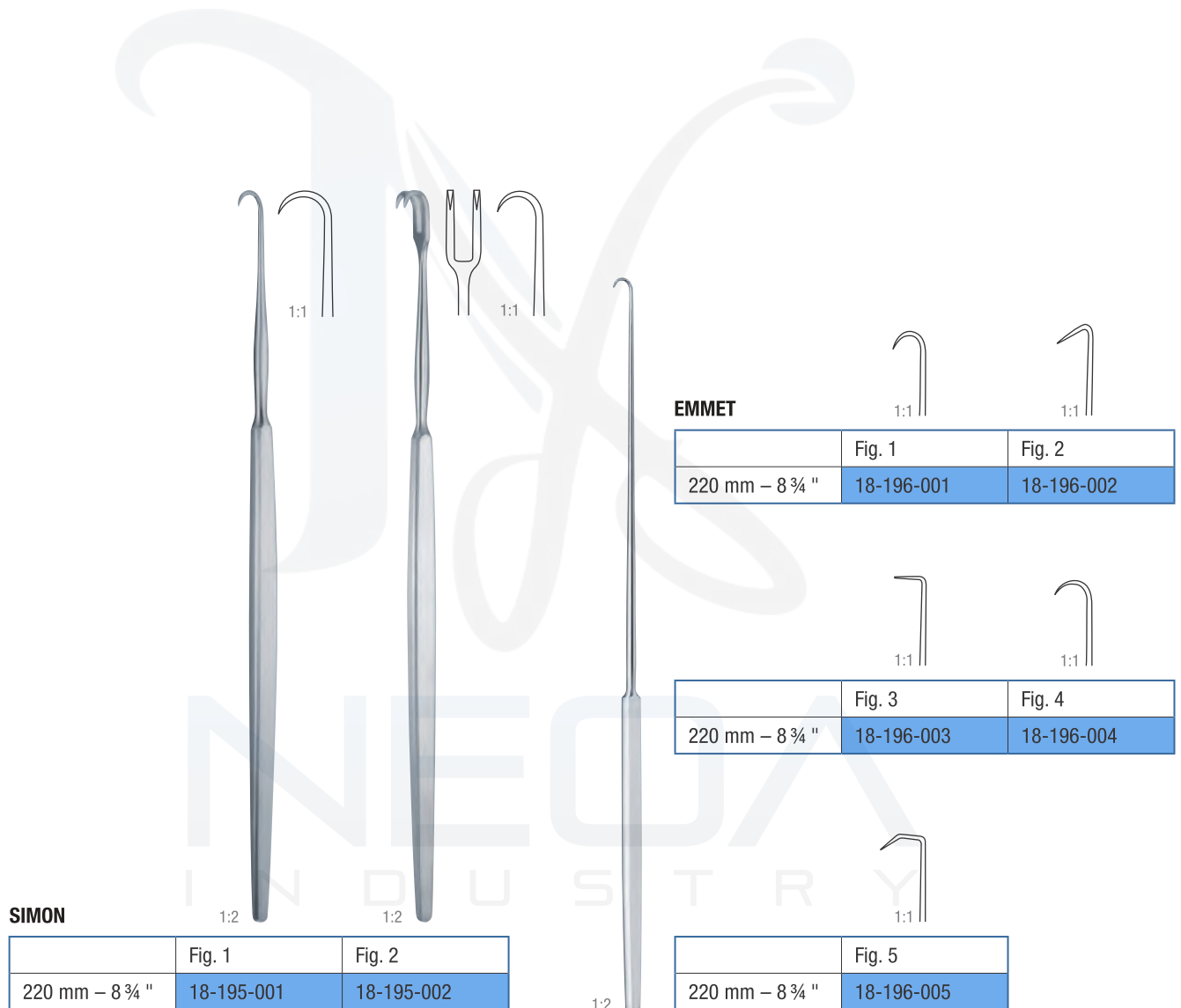

Probeexzisionszangen
Cervical biopsy and specimen forceps

Pinces emporte-pièces à biopsie
Pinzas saca-bocados para biopsia
Pinze taglianti per biopsia



SCHUBERT

210 mm – 8 ½ "	18-197-210
280 mm – 11 "	18-197-280



FAURE

210 mm – 8 ½ "	18-198-210
----------------	------------



SCHUBERT

260 mm – 10 ¼ "	18-199-260
-----------------	------------

Probeexzisionszangen
Cervical biopsy and specimen forceps

Pinces emporte-pièces à biopsie
Pinzas saca-bocados para biopsia
Pinze taglianti per biopsia



1:2

GELLHORN

230 mm – 9"

18-200-230



THOMS-GAYLOR

220 mm – 8 ¾"

18-201-220

240 mm – 9 ½"

18-201-240

Probeexzisionszangen
Cervical biopsy and specimen forceps

Pincers emporte-pièces à biopsie
Pinzas saca-bocados para biopsia
Pinze taglianti per biopsia



ALEXANDER

	280 mm – 11"
x = 200 mm – 8"	18-203-200

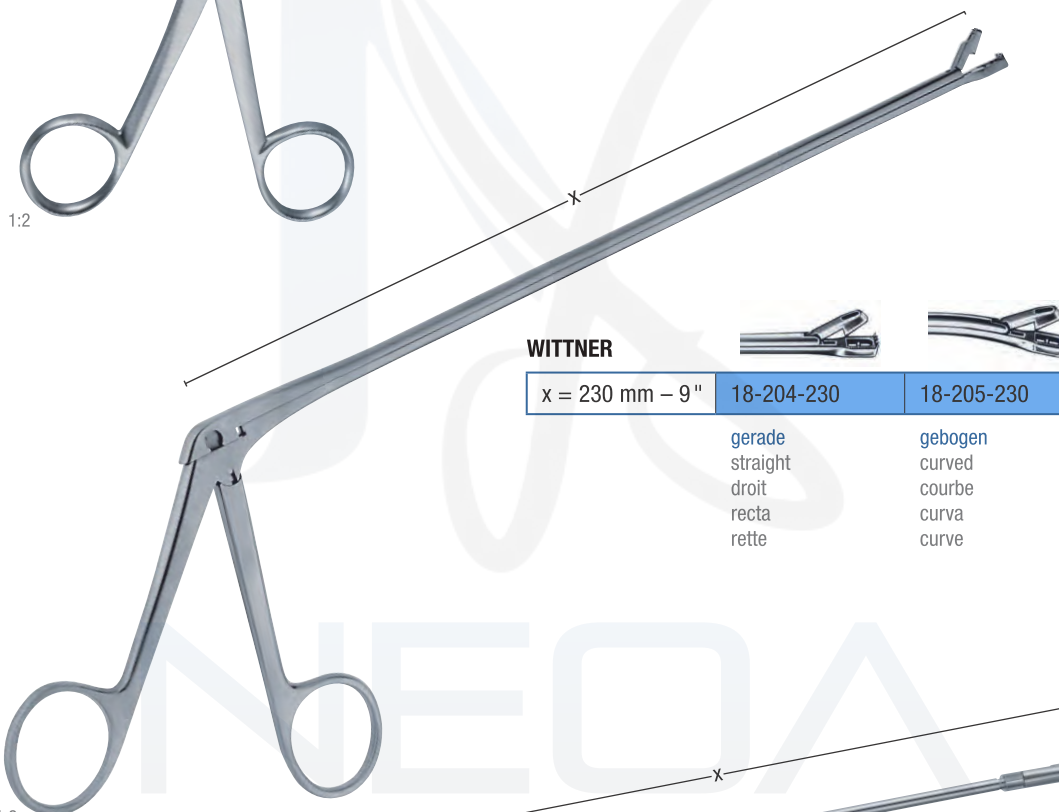

WITTNER

x = 230 mm – 9"	18-204-230	18-205-230
	gerade straight droit recta rette	gebogen curved courbe curva curve

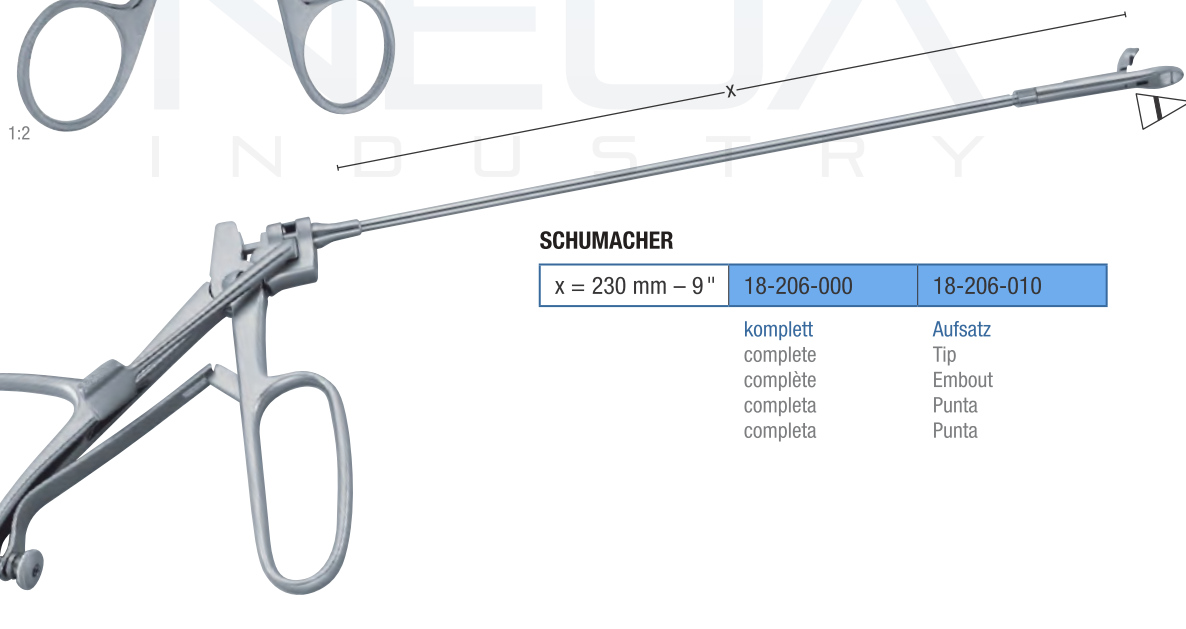

SCHUMACHER



x = 230 mm – 9"	18-206-000	18-206-010
	komplett complete complète completa completa	Aufsatz Tip Embout Punta Punta

Probeexzisionszangen
Cervical biopsy and specimen forceps

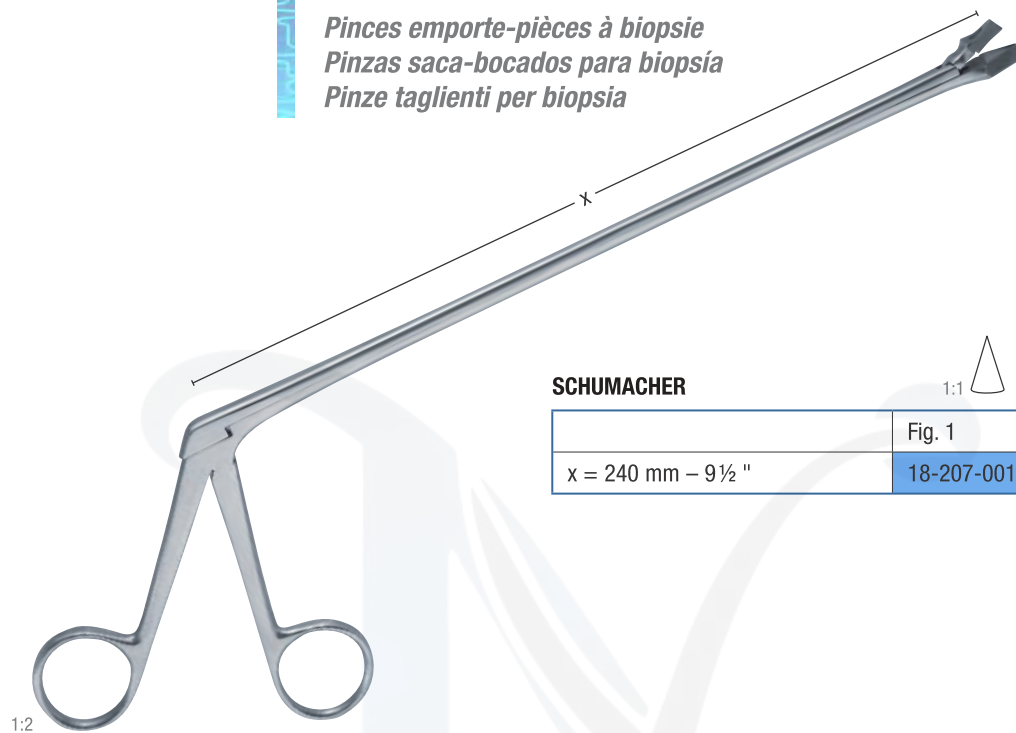
Pinces emporte-pièces à biopsie
Pinzas saca-bocados para biopsia
Pinze taglianti per biopsia



SCHUMACHER

	1:1 	1:1 
	Fig. 1	Fig. 2
x = 240 mm – 9 ½ "	18-207-001	18-207-002



1:2



VAN DOREN

250 mm – 9 ¾ "
18-208-250



1:2

SCHUMACHER

	1:1 	1:1 
	Fig. 1	Fig. 2
240 mm – 9 ½ "	18-209-001	18-209-002

Probeexzisionszangen
Cervical biopsy and specimen forceps

Pinces emporte-pièces à biopsie
Pinzas saca-bocados para biopsia
Pinze taglienti per biopsia



Probeexzisionszangen
Cervical biopsy and specimen forceps

Pinces emporte-pièces à biopsie
Pinzas saca-bocados para biopsia
Pinze taglienti per biopsia



USA MODELL

TISCHLER-MORGAN
USA MODELL

TISCHLER-
MORGAN

x = 200 mm – 8"	18-212-001	18-213-000
x = 250 mm – 9¾"	18-212-002	18-213-010

Instrument wie abgebildet, jedoch ohne Feststellschraube
 Instrument as illustrated, but without locking screw
 Instrument comme illustré, mais sans vis de fixation
 Instrumento según ilustración, pero sin tornillo de fijación
 Pinza come illustrata però senza vite di fissaggio

Probeexzisionszangen
Cervical biopsy and specimen forceps

Pinces emporte-pièces à biopsie
Pinzas saca-bocados para biopsia
Pinze taglienti per biopsia



1:2

MINI-TISCHLER
USA MODELL

MINI-
TISCHLER

x = 200 mm – 8 "	18-214-001	18-213-030
x = 250 mm – 9¾ "	18-214-002	18-213-020

Instrument wie abgebildet, jedoch ohne Feststellschraube
 Instrument as illustrated, but without locking screw
 Instrument comme illustré, mais sans vis de fixation
 Instrumento según ilustración, pero sin tornillo de fijación
 Pinza come illustrata però senza vite di fissaggio

Probeexzisionszangen Cervical biopsy and specimen forceps

Pinces emporte-pièces à biopsie
Pinzas saca-bocados para biopsia
Pinze taglienti per biopsia

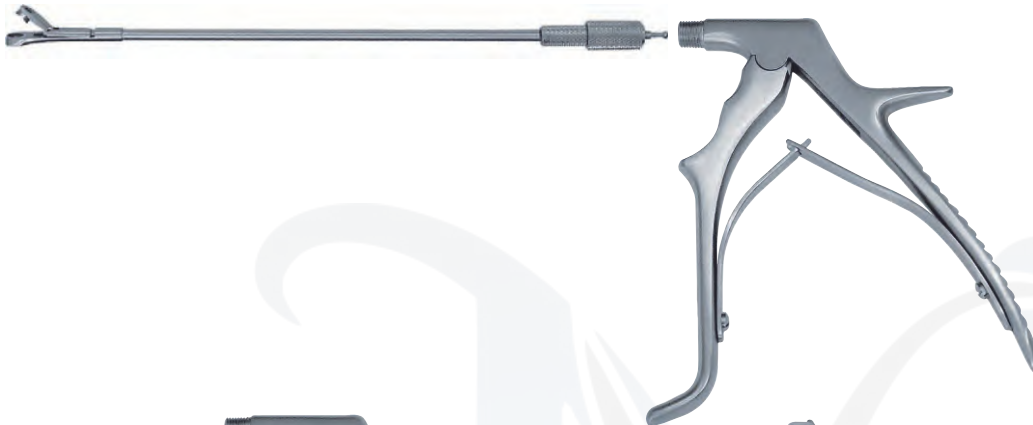

18-215-002

Uni-Griff allein
Handle only
Poignee seule
Mango sólo
Manico solo



18-215-004

Uni-Griff allein mit Ring
Handle only
Poignee seule
Mango sólo
Manico solo

TOWNSEND

3 x 7 mm 18-215-020

aufwärts, Aufsatz allein
up, Tip only
haut, mors seul
arriba, boca sola
in alto, punta sola

TOWNSEND-MINI

2.3 x 4 mm 18-215-060

gerade, Aufsatz allein
straight, Tip only
droit, mors seul
recta, boca sola
retta, punta sola

TOWNSEND-MINI

2.3 x 4 mm 18-215-050

abwärts, Aufsatz allein
down, Tip only
bas, mors seul
abajo, boca sola
in basso, punta sola

TOWNSEND-OVAL

3 x 5 mm 18-215-030

Aufsatz allein
Tip only
Mors seul
Boca sola
Punta sola

TISCHLER-MORGAN

3 x 7 mm 18-215-110

gerade, Aufsatz allein
straight, Tip only
droit, mors seul
recta, boca sola
retta, punta sola

TOWNSEND

3 x 7 mm 18-215-010

abwärts, Aufsatz allein
down, Tip only
bas, mors seul
abajo, boca sola
in basso, punta sola

TOWNSEND-MINI

2.3 x 4 mm 18-215-070

aufwärts, Aufsatz allein
up, Tip only
haut, mors seul
arriba, boca sola
in alto, punta sola

TOWNSEND-KEVORKIAN

3 x 9 mm 18-215-040

Aufsatz allein
Tip only
Mors seul
Boca sola
Punta sola

BURKE

3 x 5 mm 18-215-080

Aufsatz allein
Tip only
Mors seul
Boca sola
Punta sola

Biopsieküretten Biopsy curettes

Curettes pour biopsie
Curetas para biopsía
Curette per biopsia

KEVORKIAN



	1.2 mm Ø	1.2 mm Ø
300 mm – 12 "	18-216-120	18-217-120

fest, ohne Korb
rigid, without basket
rigide, sans panier
rígida, sin cesta
rigida, senza cestino

fest, mit Korb
rigid, with basket
rigide, avec panier
rígida, con cesta
rigida, con cestino

	4 mm Ø	4 mm Ø
	18-216-400	18-217-400

biegsam, ohne Korb
malleable, without basket
malléable, sans panier
maleable, sin cesta
flessibile, senza cestino

biegsam, mit Korb
malleable, with basket
malléable, avec panier
maleable, con cesta
flessibile, con cestino



NOVAK

	4 mm Ø
230 mm – 9 "	18-219-230

MINI-NOVAK

	235 mm – 9 ¼ "
1 mm Ø	18-220-010
2 mm Ø	18-220-020
3 mm Ø	18-220-030
4 mm Ø	18-220-040

RANDALL 1:2

	4 mm Ø
240 mm – 9 ½ "	18-218-240

1:2

absaugküretten
Aspirating curettes

Curettes d'aspiration
Curetas de aspiración
Curette per aspirazione



	200 mm – 11 ½ "
3 mm Ø	18-221-030
4.5 mm Ø	18-221-040
6 mm Ø	18-221-060
8 mm Ø	18-221-080
10 mm Ø	18-221-100
12 mm Ø	18-221-120
14 mm Ø	18-221-140

Probe- und Absaugkürette
Specimen and aspirating curette
Curette à biopsies et d'aspiration
Cureta de biopsia y de aspiración
Curette per biopsia ed per aspirazione

120 mm – 4 ¾ "	18-221-500
----------------	------------

Kupplungsstück
Coupling piece
Pièce d'accouplement
Pieza de conexión
Pezzo di connessione

1:2

Salpingograph
Salpingograph

Salpingographe
Salpingógrafo
Salpingografo

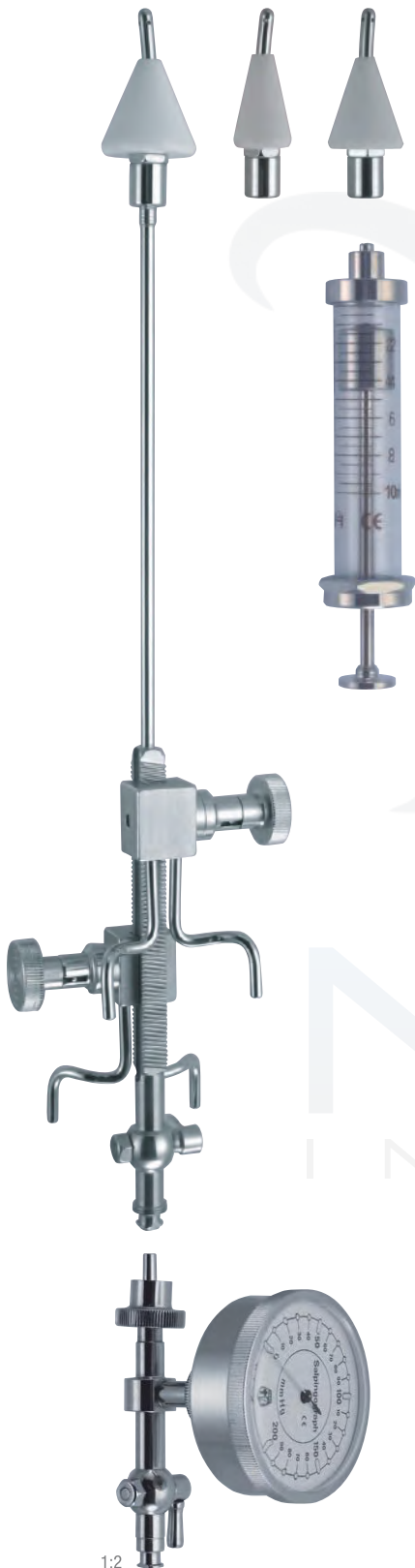

1:2

SCHULTZE

295 mm – 11 ½ "

Salpingograph, komplett im Holzetui
Salpingograph, complete in wooden case
Salpingographe, complet en etui de bois
Salpingógrafo, completa en caja de madera
Salpingografo, completo in astuccio di legno

Manometer alleine
Manometer only
Manomètre seule
Manómetro sólo
Manometro solo

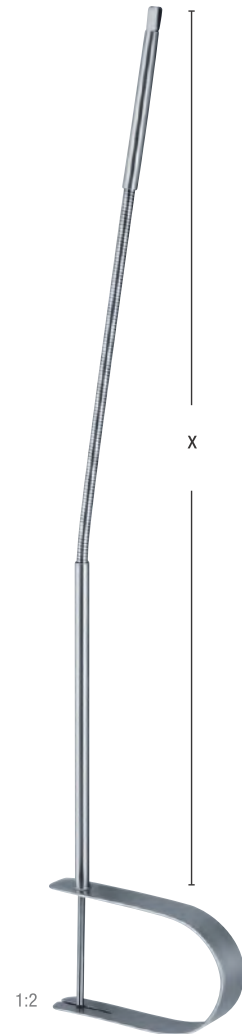

1:2

	4 mm Ø
x = 230 mm – 9 "	18-223-300

Zange zum Entfernen von Spiralen
Forceps for I.U.D. removings
Pince pour enlever des stérilets
Pinza para remover la espiral de esterilidad
Pinza per distaccare la spirale

uterusküretten
Uterine curettes

Curettes utérines
Curetas uterinas
Curette uterine

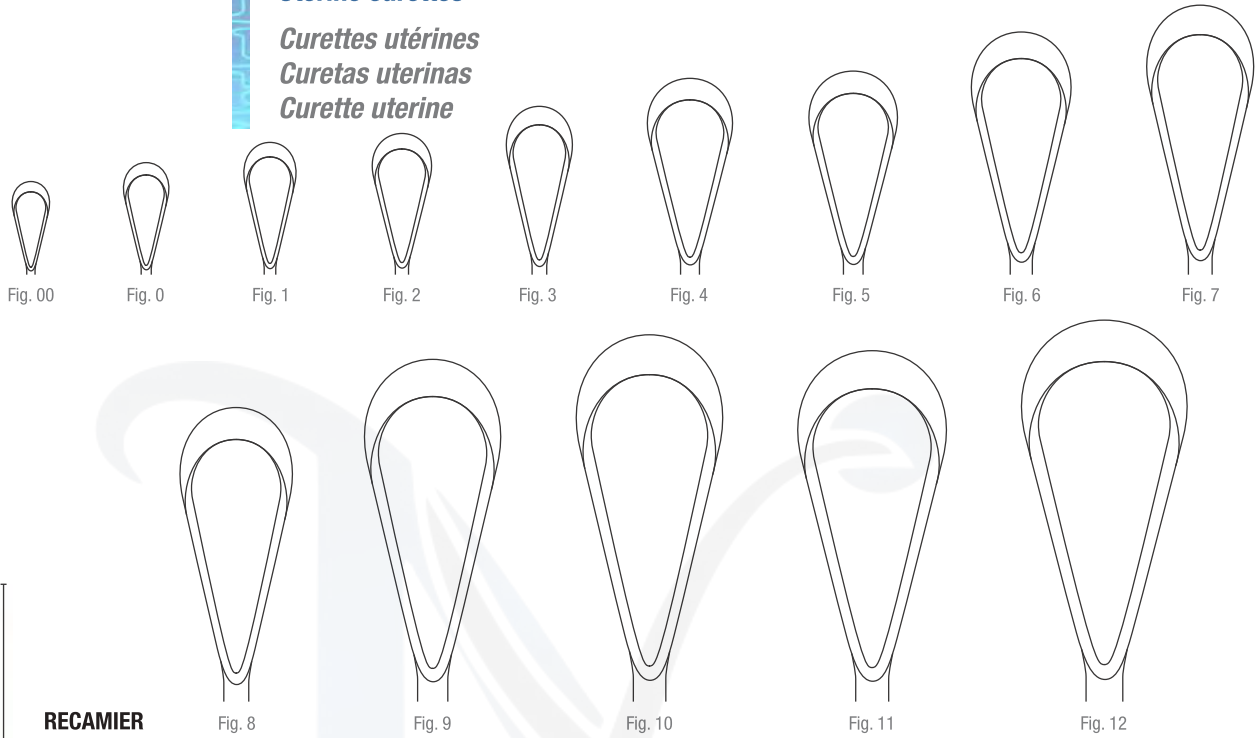

RECAMIER

y = 260 mm – 10 ¼ "	Fig.	mm				
	00	5	18-224-002	18-225-002	18-226-002	18-227-002
	0	6	18-224-003	18-225-003	18-226-003	18-227-003
	1	7	18-224-010	18-225-010	18-226-010	18-227-010
	2	8	18-224-020	18-225-020	18-226-020	18-227-020
	3	9	18-224-030	18-225-030	18-226-030	18-227-030
	4	11	18-224-040	18-225-040	18-226-040	18-227-040
	5	12	18-224-050	18-225-050	18-226-050	18-227-050
	6	14	18-224-060	18-225-060	18-226-060	18-227-060
	7	15	18-224-070	18-225-070	18-226-070	18-227-070
	8	16	18-224-080	18-225-080	18-226-080	18-227-080
	9	19	18-224-090	18-225-090	18-226-090	18-227-090
	10	20	18-224-100	18-225-100	18-226-100	18-227-100
	11	21	18-224-110	18-225-110	18-226-110	18-227-110
	12	23	18-224-120	18-225-120	18-226-120	18-227-120
y = 310 mm – 12 ¼ "	Fig.	mm				
	00	5	18-228-002	18-229-002	18-230-002	18-231-002
	0	6	18-228-003	18-229-003	18-230-003	18-231-003
	1	7	18-228-010	18-229-010	18-230-010	18-231-010
	2	8	18-228-020	18-229-020	18-230-020	18-231-020
	3	9	18-228-030	18-229-030	18-230-030	18-231-030
	4	11	18-228-040	18-229-040	18-230-040	18-231-040
	5	12	18-228-050	18-229-050	18-230-050	18-231-050
	6	14	18-228-060	18-229-060	18-230-060	18-231-060
	7	15	18-228-070	18-229-070	18-230-070	18-231-070
	8	16	18-228-080	18-229-080	18-230-080	18-231-080
	9	19	18-228-090	18-229-090	18-230-090	18-231-090
	10	20	18-228-100	18-229-100	18-230-100	18-231-100
	11	21	18-228-110	18-229-110	18-230-110	18-231-110
	12	23	18-228-120	18-229-120	18-230-120	18-231-120

scharf, starr
sharp, rigid
tranchante, rigide
cortante, rígida
tagliente, rigida

scharf, biegsam
sharp, malleable
tranchante, malléable
cortante, maleable
tagliente, flessibile

stumpf, starr
blunt, rigid
mousse, rigid
roma, rígida
smussa, rigida

stumpf, biegsam
blunt, malleable
mousse, malléable
roma, maleable
smussa, flessibile

uterusküretten
Uterine curettes

Curettes utérines
Curetas uterinas
Curette uterine



Fig. 13

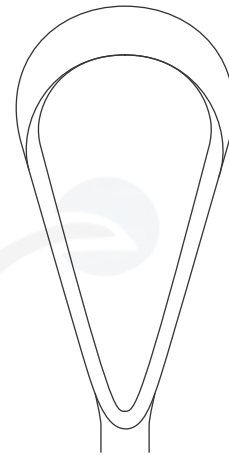

Fig. 14

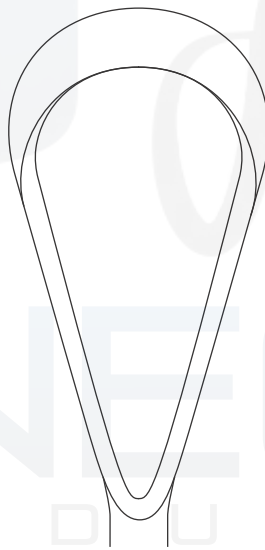

Fig. 15



Fig. 16

RECAMIER

y = 340 mm – 13 ½ "	Fig.	x = mm				
	13	25	18-228-130	18-229-130	18-230-130	18-231-130
	14	30	18-228-140	18-229-140	18-230-140	18-231-140
	15	35	18-228-150	18-229-150	18-230-150	18-231-150
	16	40	18-228-160	18-229-160	18-230-160	18-231-160

scharf, starr
sharp, rigid
tranchante, rigide
cortante, rígida
tagliente, rigida

scharf, biegsam
sharp, malleable
tranchante, malléable
cortante, maleable
tagliente, flessibile

stumpf, starr
blunt, rigid
mousse, rigid
roma, rígida
smussa, rigida

stumpf, biegsam
blunt, malleable
mousse, malléable
roma, maleable
smussa, flessibile

Scharfe Löffel Uterine spoons

Curettes tranchantes
Cucharillas cortantes
Cucchiai taglienti



SIMON



	Fig. 1	Fig. 2	Fig. 3
250 mm – 9¾"	18-232-001	18-232-002	18-232-003

scharf, fest
sharp, rigid
tranchante, rigide
cortante, rígida
taglienti, rigido



Fig. 4	Fig. 5	Fig. 6
18-232-004	18-232-005	18-232-006



SCHRÖDER



	Fig. 1	Fig. 2	Fig. 3
300 mm – 12"	18-233-001	18-233-002	18-233-003

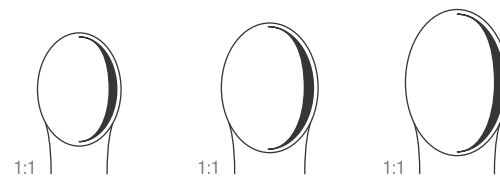

Fig. 4	Fig. 5	Fig. 6
18-233-004	18-233-005	18-233-006

Geburtszangen

Obstetrical forceps

Forceps obstétriques

Forceps obstétricos

Forcipi



SIMPSON

1:3

300 mm – 12 "

18-234-300



**SIMPSON-
BRAUN**

330 mm – 13 "

18-235-330

360 mm – 14 ¼ "

18-236-360



NAEGELE

360 mm – 14 ¼ "

18-237-360

400 mm – 16 "

18-237-400



PIPER

1:3

440 mm – 17 ¼ "

18-238-440

Geburtszangen

Obstetrical forceps

Forceps obstétriques

Forceps obstétricos

Forcipi



**SIMPSON-
LUIKART**

1:3

360 mm – 14 ¼ "	18-239-360
-----------------	------------



WRIGLEY

1:3

230 mm – 9 "	18-240-230
--------------	------------

für Kaiserschnitt
for caesarian section
pour césarienne
para operación cesárea
per taglio cesareo



DE LEE

1:3

300 mm – 12 "	18-241-300
---------------	------------



DE LEE

360 mm – 14 ¼ "	18-242-360
-----------------	------------

390 mm – 15 ½ "	18-242-390
-----------------	------------

Geburtszangen
Obstetrical forceps

Forceps obstétriques

Forceps obstétricos

Forcipi



ELLIOT

320 mm – 12 ½ "	18-243-320
380 mm – 15 "	18-243-380

MCLEAN

1:3

360 mm – 14 ¼ "	18-244-360
-----------------	------------

KIELLAND

1:3

410 mm – 16 ¼ "	18-245-410
-----------------	------------

KIELLAND-LUIKAR T

1:3

400 mm – 16 "	18-246-400
---------------	------------

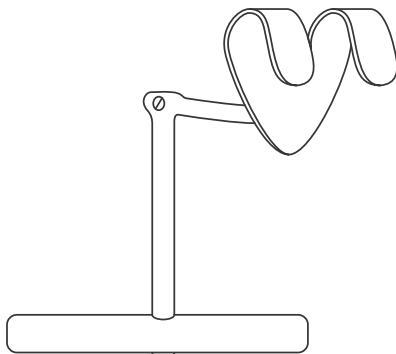

BILL

18-247-000

Zughebel, passend für alle Geburtszangen mit gehornem Standard-Griff
Traction handle for all the forceps with horned standard handle
Dispositif de traction pour tous les forceps avec manche normal à cornes
Dispositivo de tracción para todos los forceps con mango standard con curva
Impugnatura di trazione adatto a tutti i forcipi con manico standard con corne

Geburtshilfe
Obstetrics

Obstétrique
Obstétrica
Ostetricia



SELLHEIM

1:2

280 mm – 11 " 18-248-280

Geburtslöffel
Obstetric lever
Cuillère obstétricale
Cuchara obstétrica
Cucchaio obstetrico

BRAUN 1:2

300 mm – 12 " 18-249-300

Dekapitationshaken
Decapitating hook
Crochet de décapitation
Gancho de decapitación
Uncino di decapitazione

GREEN-ARMYTAGE

1:2

210 mm – 8 ¼ " 18-250-210

Uterusklemmzange
Uterine elevating forceps
Pince uterine
Pinza para el utero
Pinza uterina

Geburtshilfe
Obstetrics

Obstétrique
Obstétrica
Ostetricia



SMELLIE

1:3

250 mm – 10 "

18-251-250

Perforatorium
Perforator
Perforateur
Perforador
Perforatore



BRAUN

1:3

420 mm – 16 ½ "

18-252-420

Kranioklast, ein Maul gefenstert
Cranioclast, one jaw fenestrated
Cranioclaste, une partie fenestrée
Craneolasto, una boca fenestrada
Cranioclaste, un lato fenestrato



TARNIER

1:3

460 mm – 17 ¼ "

18-253-460

Basiotrib
Basiotribe
Basiotribe
Basiotribo
Basiotribo

abortuszangen – abortusküretten
Abortion forceps – Ovum curettes

Pinces à faux germes – Curette d'avortement

Pinzas para aborto – Curetas para aborto

Pinze per placenta ed aborto – Curette per placenta ed aborto



WINTER

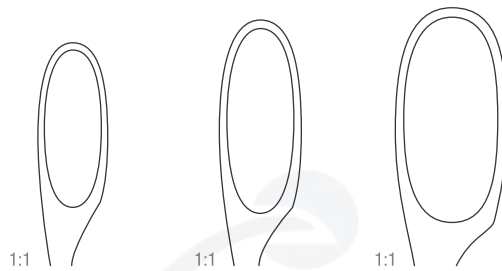

	Fig. 1	Fig. 2	Fig. 3
280 mm – 11 "	18-254-001	18-254-002	18-254-003

gerade
straight
droit
recta
rette

18-255-001	18-255-002	18-255-003
------------	------------	------------

gebogen
curved
courbe
curva
curve



CUZZI

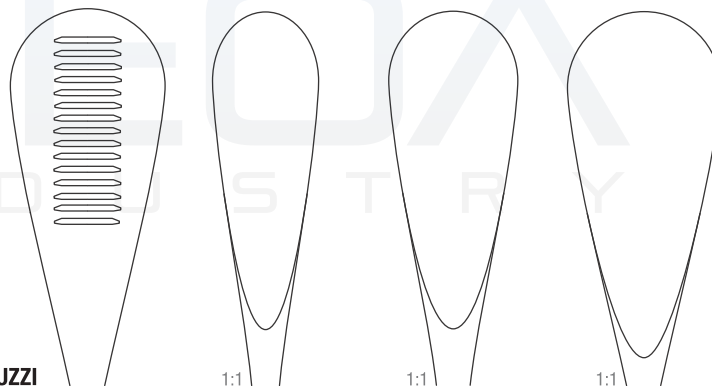

	14.5 mm	18.0 mm	21.0 mm
300 mm – 12 "	18-256-140	18-256-180	18-256-210

stumpf, Rückseite gerieft
blunt, back serrated
mousse, dos strié
romo, dorso estriado
smusso, dorso zigrinato

abortuszangen – abortusküretten
Abortion forceps – Ovum curettes

Pinces à faux germes – Curette d'avortement

Pinzas para aborto – Curetas para aborto

Pinze per placenta ed aborto – Curette per placenta ed aborto



1:2

SAENGER

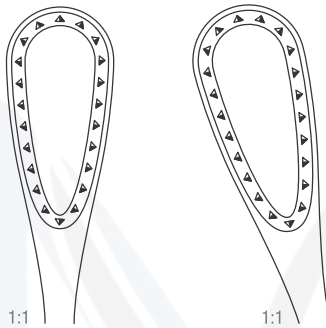

1:1

1:1

270 mm – 10 3/4 "

18-257-270

18-258-270



1:1

PESTALOZZA

1:3

300 mm – 12 "

18-259-300

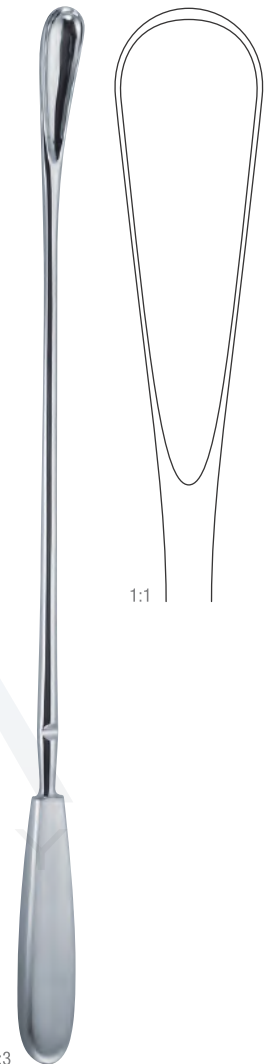

1:1

WALLICH

1:3

420 mm – 16 1/2 "

18-260-420

stumpf
 blunt
 mousse
 roma
 smussa

Beckenzirkel
Pelvimeters

Pelvimètres
Pelvimetros
Pelvimetri



MARTIN

1:3

340 mm – 13 ½ " 18-263-340

cm / Zoll-Scala
cm / inch-scale
échelle en cm / pouces
escala cm / pulgadas
scala cm / pollici



COLLIN

1:3

350 mm – 13 ¾ " 18-264-350

cm-Scala
cm-scale
échelle en cm
escala en cm
scala in cm



Manufacturer & Supplier Premium Quality Surgical, Dental, Podiatry, Pet Grooming and Beauty Care Instruments.

USA Address:

 5900 Balcones Drive # 16244
Austin TX, USA 78731.
 +1 (917) 773 3694
 **uk:** +44 7871 836765
 info@neoaindustry.com
neoaindustry4@gmail.com
 www.neoaindustry.com

Main Head Office:

 Roars Road New Miana Pura
West, Sialkot 51310 Pakistan.
 +92 322 5587688
 +92 322 5587688
 info@neoaindustry.com
neoaindustry4@gmail.com
 www.neoaindustry.com

