

» **Arterienklemmen**

» **Haemostatic forceps**

» **Pinces hémostatiques**

» **Pinzas hemostáticas**

» **Pinze emostatiche**



**Gefäßklemmen**  
**Haemostatic forceps**

**Serre-fines**  
**Serrafinas**  
**Serrafine**



**DIEFFENBACH**

35 mm – 1½"	04-101-035	04-102-035
50 mm – 2"	04-101-050	04-102-050
60 mm – 2¼"	04-101-060	04-102-060



**J•HNS-H•PKINS**

38 mm – 1½"	04-106-038	04-107-038
51 mm – 2"	04-106-051	04-107-051
57 mm – 2¼"	04-106-057	04-107-057
63 mm – 2½"	04-106-063	04-107-063
70 mm – 2¾"	04-106-070	04-107-070
75 mm – 3"	04-106-075	04-107-075
90 mm – 3½"	04-106-090	04-107-090

gerade  
straight  
droit  
recta  
retto

gebogen  
curved  
courbe  
curva  
curvo



**DIETRICH**

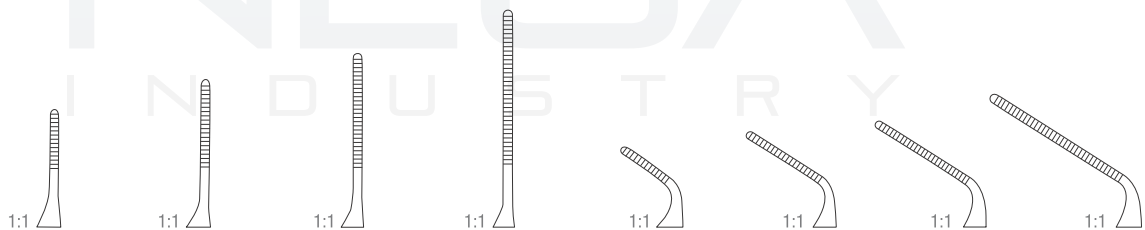

x =	50 mm – 2"	50 mm – 2"	50 mm – 2"	60 mm – 2¼"	50 mm – 2"	50 mm – 2"	50 mm – 2"	60 mm – 2¼"
y =	8 mm	12 mm	16 mm	20 mm	8 mm	12 mm	16 mm	20 mm
	04-110-008	04-110-012	04-110-016	04-110-020	04-111-008	04-111-012	04-111-016	04-111-020

x = Länge  
x = Length  
x = Longueur  
x = longitud  
x = Lunghezza

y = geriefte Maullänge  
y = serrated jaw part  
y = partie striée du mors  
y = boca aserrada  
y = morso zigrinato

### Arterienklemmen

#### Haemostatic forceps

*Pinces hémostatiques*  
*Pinzas hemostáticas*  
*Pinze emostatiche*



**HARTMANN**

100 mm – 4 "	04-112-100	13-021-100
--------------	------------	------------

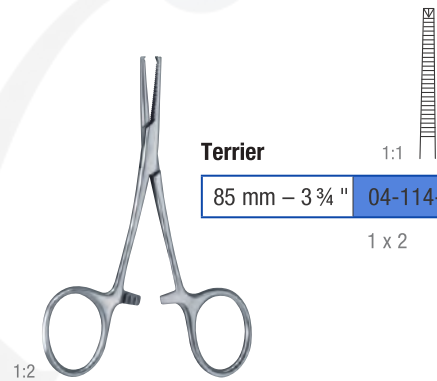
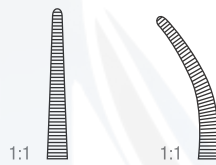

**Terrier**

85 mm – 3 ¼ "	04-114-080
---------------	------------

1 x 2



**HALSTED-M•SQUIT**

125 mm – 5 "	04-115-125	04-116-125	04-118-125	04-119-125
140 mm – 5 ½ "	04-115-140	04-116-140	04-118-140	04-119-140

1 x 2

1 x 2

	<b>Titan</b>	<b>Titan</b>	<b>Titan</b>	<b>Titan</b>
125 mm – 5 "	04-120-120	04-121-120	04-122-120	04-123-120

1 x 2

1 x 2

### Arterienklemmen

#### Haemostatic forceps

*Pinces hémostatiques*  
*Pinzas hemostáticas*  
*Pinze emostatiche*



#### MICR-M-SQUIT

100 mm – 4 "	13-028-100	13-029-100	13-030-100	13-031-100
120 mm – 4 ¾ "	13-028-120	13-029-120	13-030-120	13-031-120

1 x 2

1 x 2

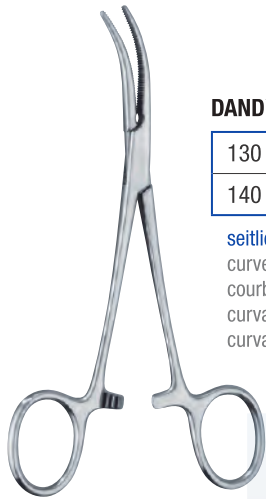

#### DANDY

130 mm – 4 "	04-130-130	
140 mm – 5 ½ "	04-130-140	04-131-140

seitlich gebogen  
 curved to the side  
 courbe sur le plat  
 curva al lado  
 curvata lateralmente

1 x 2



#### M-SQUIT-DANDY

1:1

120 mm – 4 ¾ "	04-132-120
----------------	------------

seitlich gebogen  
 curved to the side  
 courbe sur le plat  
 curva al lado  
 curvata lateralmente



1:2

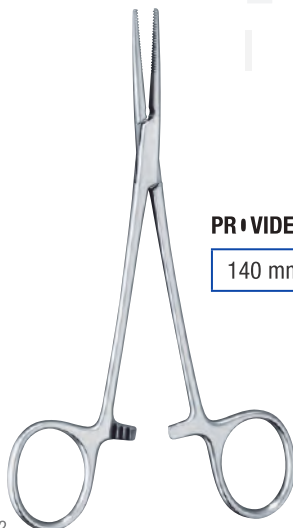

#### PROVIDENCE-H-SPIRAL

140 mm – 5 ½ "	04-133-140	04-134-140
----------------	------------	------------

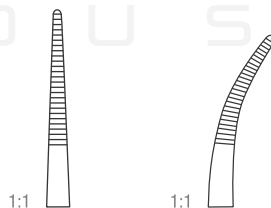

1:1

1:1

1:2

### Arterienklemmen

#### Haemostatic forceps

*Pinces hémostatiques*  
*Pinzas hemostáticas*  
*Pinze emostatiche*



#### CHRISTOPHE

130 mm – 4 "	04-135-130
150 mm – 6 "	04-135-150



#### LVELACE

155 mm – 6 "	04-136-155	04-138--150
--------------	------------	-------------

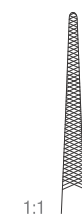
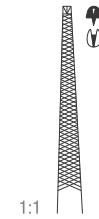

1 x 2

1:2



#### LERICHE

150 mm – 6 "	04-140-150	04-142-150
--------------	------------	------------

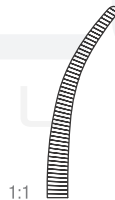

1:1

1:1

1:2



#### LERICHE

150 mm – 6 "	04-143-150	04-144-150
--------------	------------	------------

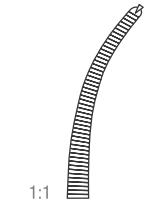

1:1

1:1

1 x 2

1:2

### Arterienklemmen

#### Haemostatic forceps

*Pinces hémostatiques*  
*Pinzas hemostáticas*  
*Pinze emostatiche*



#### KELL Y

140 mm – 5½ "	04-145-140	04-146-140
---------------	------------	------------

#### KELL Y-RANKIN

160 mm – 6¼ "	04-147-160	04-148-160
---------------	------------	------------

#### KELL Y

	Titan	Titan
140 mm – 5½ "	04-150-140	04-151-140

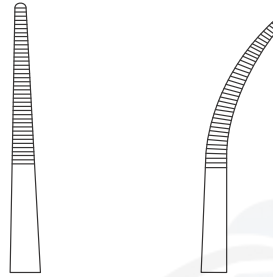

#### CRILE

140 mm – 5½ "	04-152-140	04-153-140	04-154-140	04-155-140
			1 x 2	1 x 2

#### CRILE-RANKIN

160 mm – 6¼ "	04-160-160	04-161-160	04-163-160	04-164-160
			1 x 2	1 x 2

#### CRILE

	Titan	Titan
140 mm – 5½ "	04-165-140	04-166-140

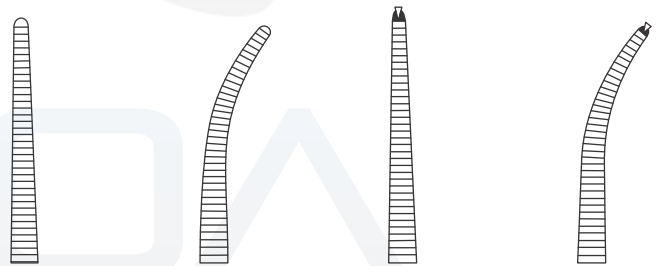

### Arterienklemmen

### Haemostatic forceps

*Pinces hémostatiques*  
*Pinzas hemostáticas*  
*Pinze emostatiche*



#### CULLER-CRILE

140 mm – 5 ½ "	04-167-140	04-168-140
160 mm – 6 ¼ "	04-167-160	04-168-160

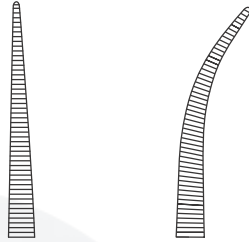

#### PÉAN

130 mm – 5 "	04-169-130	04-170-130
140 mm – 5 ½ "	04-171-140	04-172-140
160 mm – 6 ¼ "	04-169-160	04-170-160

graziles Modell  
 delicate pattern  
 modèle délicat  
 modelo delicado  
 modello delicato

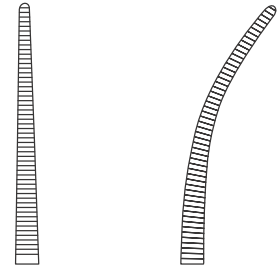

#### DUNHILL

125 mm – 5 "	04-173-130	12-273-130
--------------	------------	------------

gebogen  
 curved  
 courbe  
 curva  
 curvo

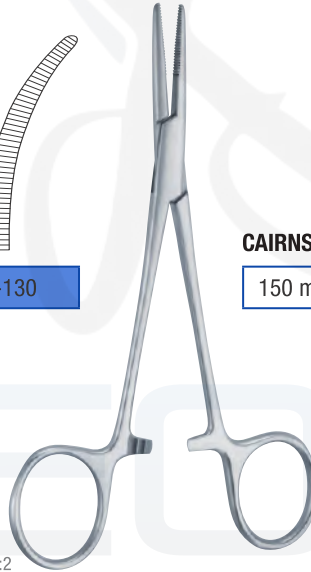
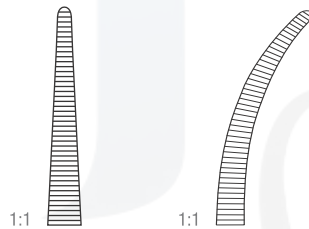

#### CAIRNS

150 mm – 6 "	04-175-140	04-176-140
--------------	------------	------------

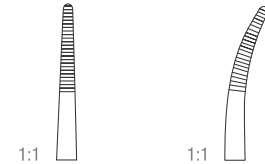

1:2

1:2



#### KOCHER

130 mm – 5 "	04-177-130	04-178-130
140 mm – 5 ½ "	04-179-140	04-180-140
160 mm – 6 ¼ "	04-179-160	04-178-160

graziles Modell  
 delicate pattern  
 modèle délicat  
 modelo delicado  
 modello delicato

1 x 2

1 x 2

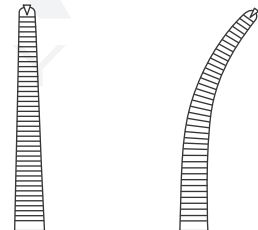

### Arterienklemmen

#### Haemostatic forceps

*Pinces hémostatiques*  
*Pinzas hemostáticas*  
*Pinze emostatiche*

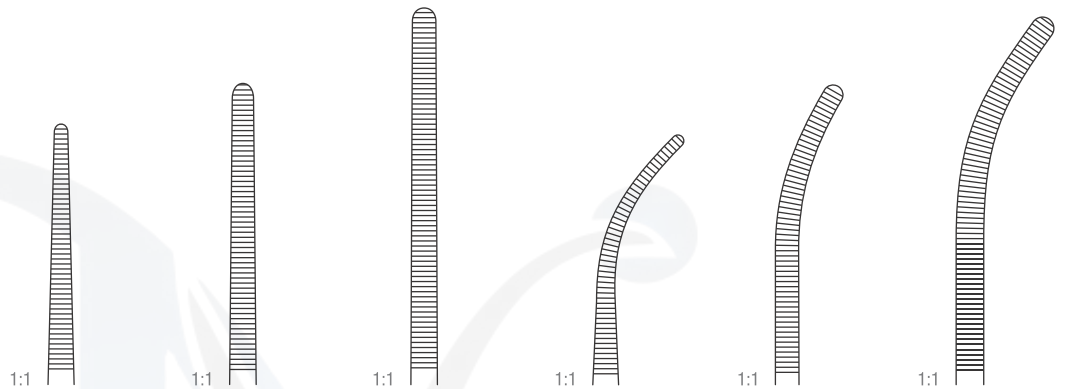

#### PÉAN-FIN

140 mm – 5 ½ "	165 mm – 6 ½ "	185 mm – 7 ¼ "	140 mm – 5 ½ "	160 mm – 6 ¼ "	180 mm – 7 "
04-181-140	04-181-160	04-181-180	04-182-140	04-182-160	04-182-180

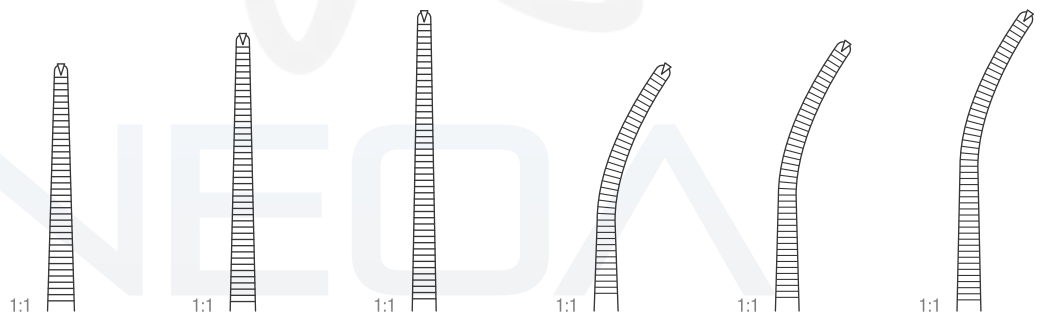

#### KICHER-FIN

145 mm – 5 ¾ "	165 mm – 6 ½ "	185 mm – 7 ¼ "	145 mm – 5 ¾ "	160 mm – 6 ¼ "	180 mm – 7 "
04-183-140	04-183-160	04-183-180	04-184-140	04-184-160	04-184-180
1 x 2	1 x 2	1 x 2	1 x 2	1 x 2	1 x 2



### Arterienklemmen

#### Haemostatic forceps

*Pinces hémostatiques*  
*Pinzas hemostáticas*  
*Pinze emostatiche*

TC

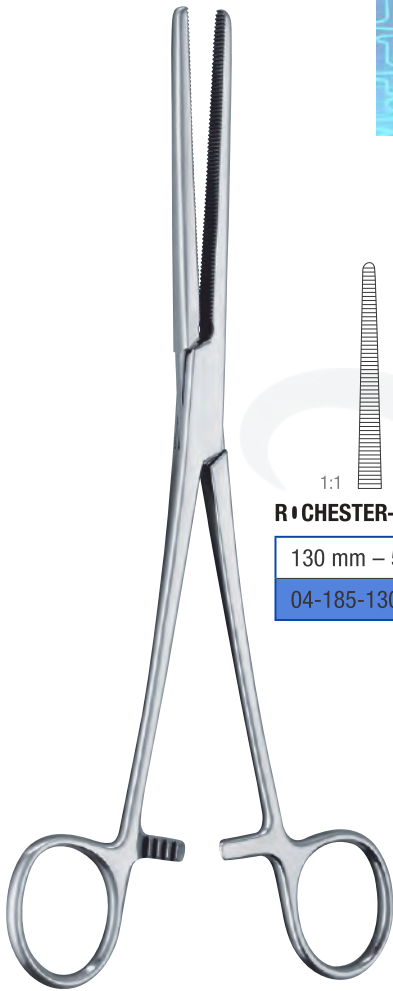

1:1

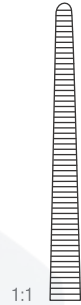

1:1

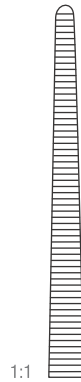

1:1



1:1



1:1

#### RICHES-PEAN

130 mm – 5 "	140 mm – 5 ½ "	160 mm – 6 ¼ "	180 mm – 7 "	200 mm – 8 "
04-185-130	04-185-140	04-185-160	04-185-180	04-185-200

Atrauma	Atrauma	Atrauma	Atrauma
140 mm – 5 ½ "	160 mm – 6 ¼ "	180 mm – 7 "	200 mm – 8 "
04-186-140	04-186-160	04-186-180	04-186-200

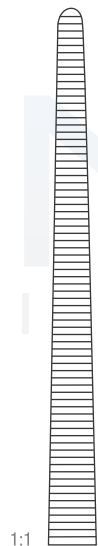

1:1



1:1

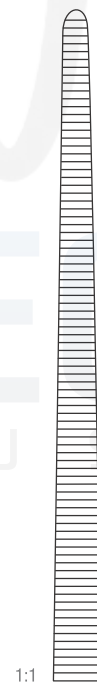

1:1



1:1



1:1

220 mm – 8 ¾ "	240 mm – 9 ½ "	260 mm – 10 ¼ "	300 mm – 12 "	350 mm – 14 "
04-185-220	04-185-240	04-185-260	04-185-300	04-185-350

Atrauma	Atrauma
260 mm – 10 ¼ "	300 mm – 12 "
04-186-265	04-186-280

### Arterienklemmen

#### Haemostatic forceps

*Pinces hémostatiques*  
*Pinzas hemostáticas*  
*Pinze emostatiche*

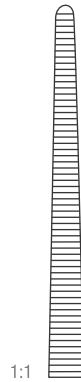
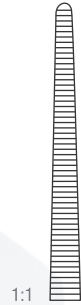
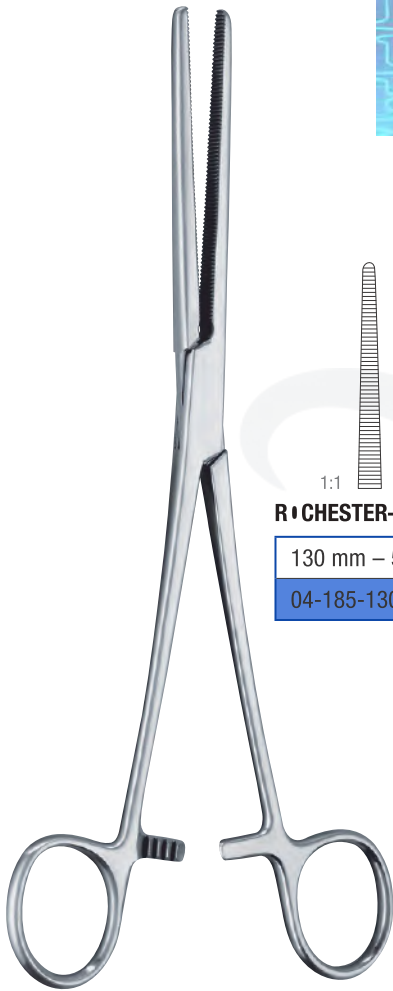

#### RICHES-PEAN

130 mm – 5 "	140 mm – 5 ½ "	160 mm – 6 ¼ "	180 mm – 7 "	200 mm – 8 "
04-185-130	04-185-140	04-185-160	04-185-180	04-185-200

Atrauma	Atrauma	Atrauma	Atrauma
140 mm – 5 ½ "	160 mm – 6 ¼ "	180 mm – 7 "	200 mm – 8 "
04-186-140	04-186-160	04-186-180	04-186-200



220 mm – 8 ¾ "	240 mm – 9 ½ "	260 mm – 10 ¼ "	300 mm – 12 "	350 mm – 14 "
04-185-220	04-185-240	04-185-260	04-185-300	04-185-350

Atrauma	Atrauma
260 mm – 10 ¼ "	300 mm – 12 "
04-186-265	04-186-280

### Arterienklemmen

#### Haemostatic forceps

*Pinces hémostatiques*  
*Pinzas hemostáticas*  
*Pinze emostatiche*

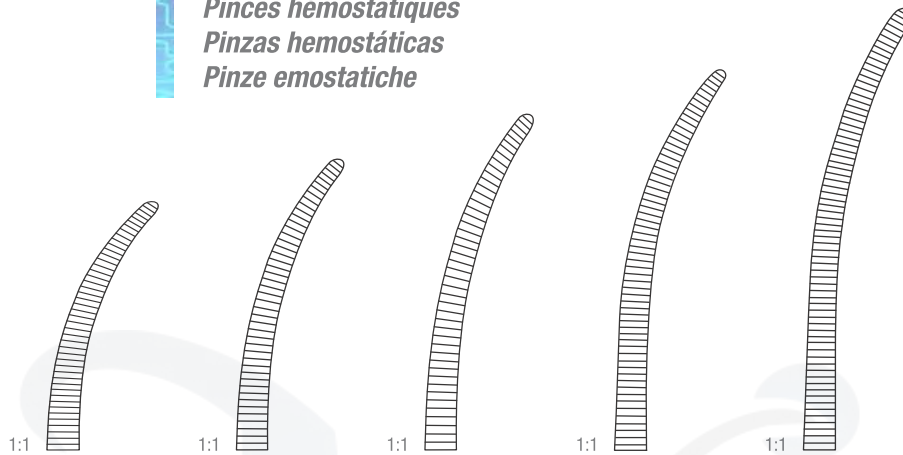

#### R • CHESTER-PÉAN

130 mm – 5 "	140 mm – 5 ½ "	160 mm – 6 ¼ "	180 mm – 7 "	200 mm – 8 "
04-187-130	04-187-140	04-187-160	04-187-180	04-187-200

Atrauma	Atrauma	Atrauma	Atrauma
140 mm – 5 ½ "	160 mm – 6 ¼ "	180 mm – 7 "	200 mm – 8 "
04-188-140	04-188-160	04-188-180	04-188-200

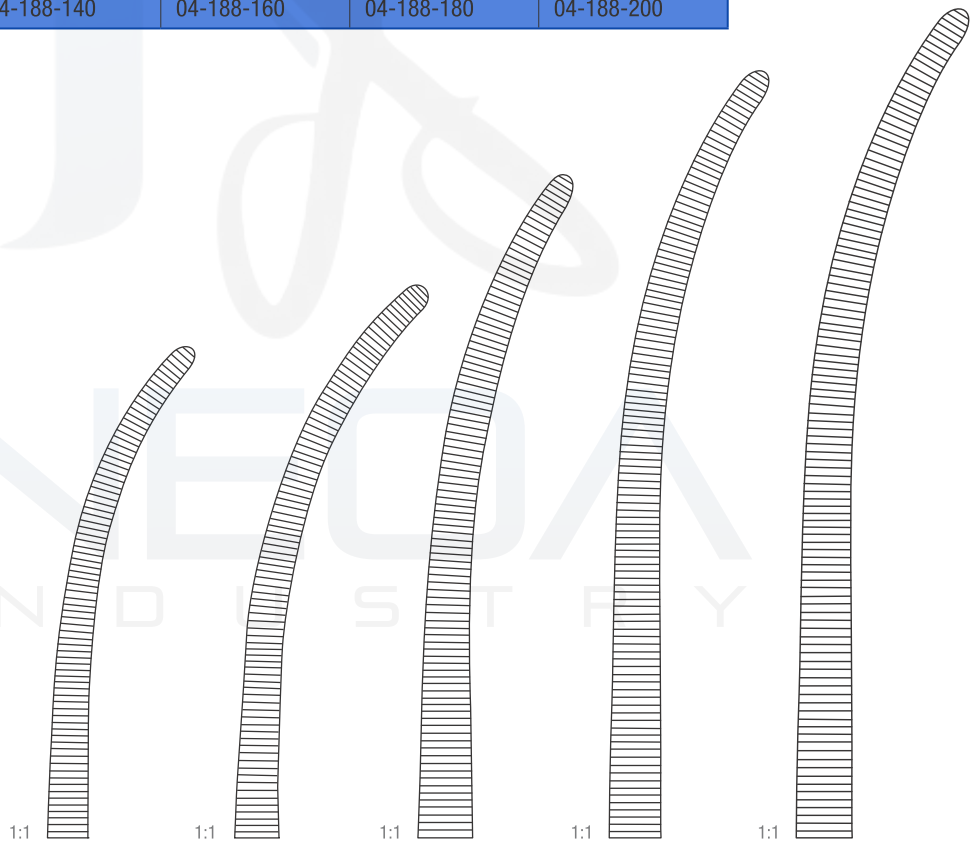

220 mm – 8 ¾ "	240 mm – 9 ½ "	260 mm – 10 ¼ "	300 mm – 12 "	350 mm – 14 "
04-187-220	04-187-240	04-187-260	04-187-300	04-187-350

Atrauma	Atrauma
260 mm – 10 ¼ "	300 mm – 12 "
04-188-260	04-188-275

# Arterienklemmen

## Haemostatic forceps

Arterienklemmen  
Haemostatic forceps

Pinces hémostatiques  
Pinzas hemostáticas  
Pinze emostatiche

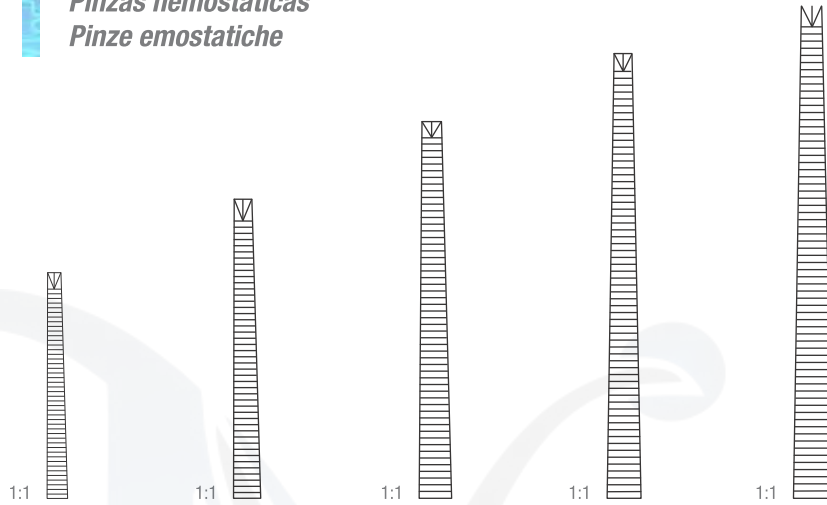

**CHSNER-K • CHER**

130 mm – 5 "	140 mm – 5 ½ "	160 mm – 6 ¼ "	180 mm – 7 "	200 mm – 8 "
04-189-130	04-189-140	04-189-160	04-189-180	04-189-200
1 x 2	1 x 2	1 x 2	1 x 2	1 x 2

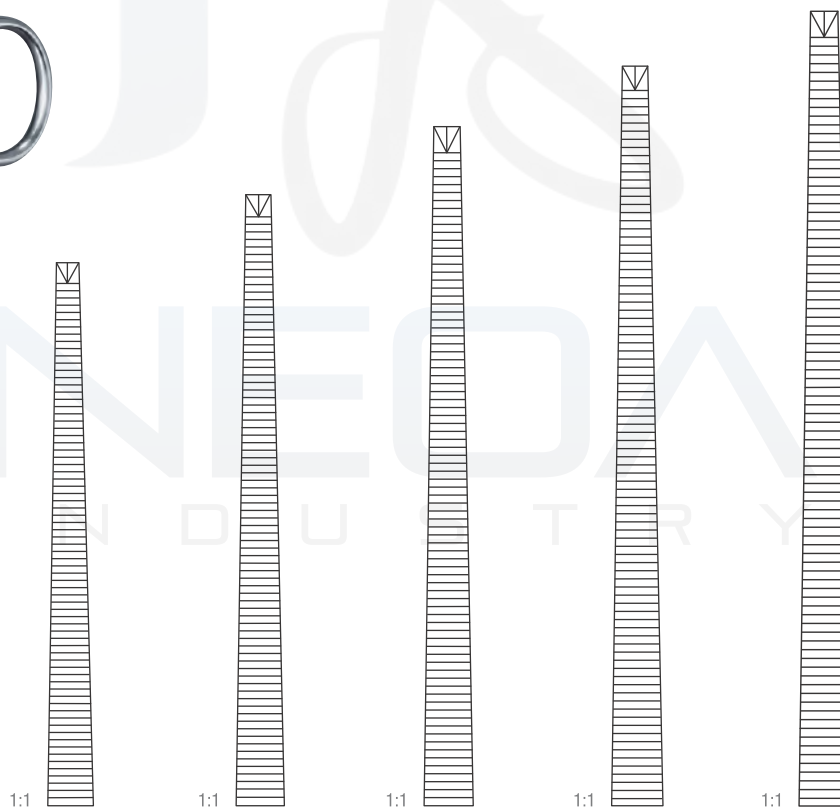

220 mm – 8 ¾ "	240 mm – 9 ½ "	260 mm – 10 ¼ "	300 mm – 12 "	300 mm – 14 "
04-189-220	04-189-240	04-189-260	04-189-300	04-189-350
1 x 2	1 x 2	1 x 2	1 x 2	1 x 2

Arterienklemmen  
Haemostatic forceps

*Pinces hémostatiques*  
*Pinzas hemostáticas*  
*Pinze emostatiche*



CHSNER-K•CHER

130 mm – 5 "	140 mm – 5 ½ "	160 mm – 6 ¼ "	180 mm – 7 "	200 mm – 8 "
04-190-130	04-190-140	04-190-160	04-190-180	04-190-200
1 x 2	1 x 2	1 x 2	1 x 2	1 x 2

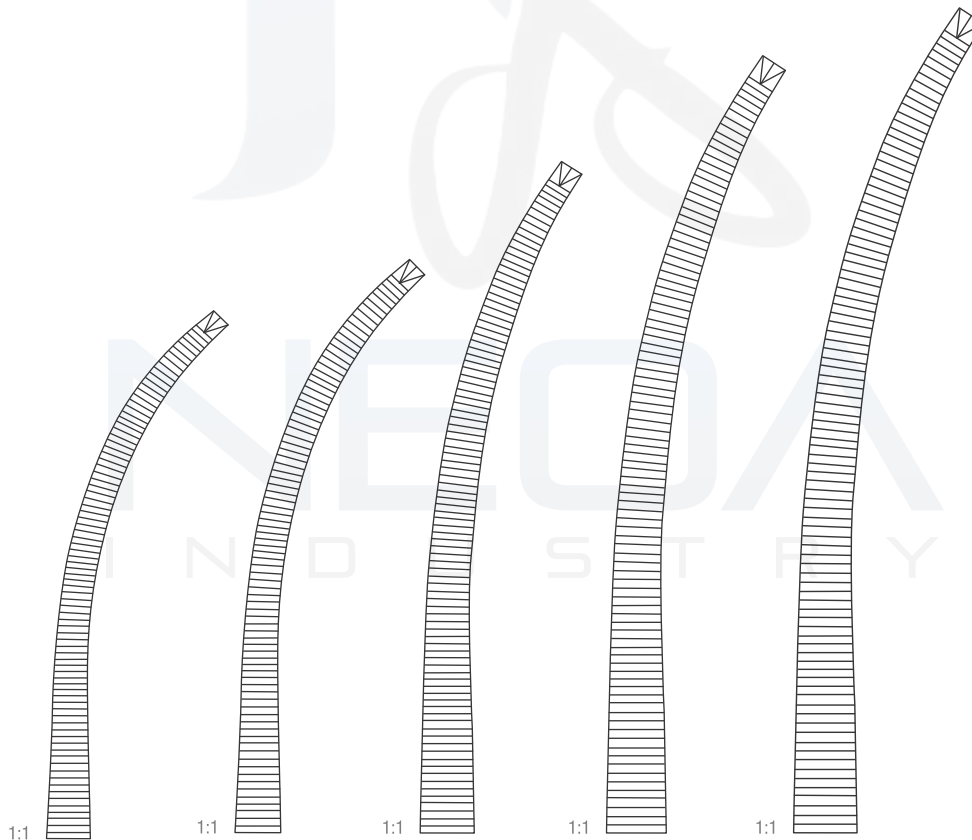

220 mm – 8 ¾ "	240 mm – 9 ½ "	260 mm – 10 ¼ "	300 mm – 12 "	350 mm – 14 "
04-190-220	04-190-240	04-190-260	04-190-300	04-190-350
1 x 2	1 x 2	1 x 2	1 x 2	1 x 2

Arterienklemmen  
*Haemostatic forceps*

*Pinces hémostatiques*  
*Pinzas hemostáticas*  
*Pinze emostatiche*



**BIRKETT**

190 mm – 7 ½ "



1:1

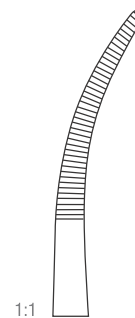

1:1

04-191-180	04-192-180
------------	------------



**BAINBRIDGE**

150 mm – 6 "

185 mm – 7 ¼ "

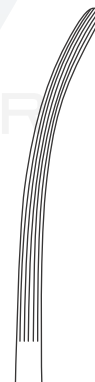

04-193-150	04-194-150
04-193-185	04-194-185

Arterienklemmen  
**Haemostatic forceps**

*Pinces hémostatiques*  
*Pinzas hemostáticas*  
*Pinze emostatiche*



**PÉAN**

140 mm – 5 ½ "	04-195-140
160 mm – 6 ¼ "	04-195-160



**R•CHESTER-CARMALT**

160 mm – 6 ¼ "	04-196-160	04-197-160
200 mm – 8 "	04-196-200	04-197-200

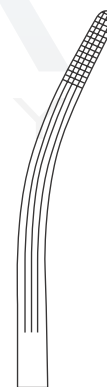

### Arterienklemmen

#### Haemostatic forceps

*Pinces hémostatiques*  
*Pinzas hemostáticas*  
*Pinze emostatiche*



1:2  
**CHAPUT**

130 mm – 5"	04-198-130
-------------	------------

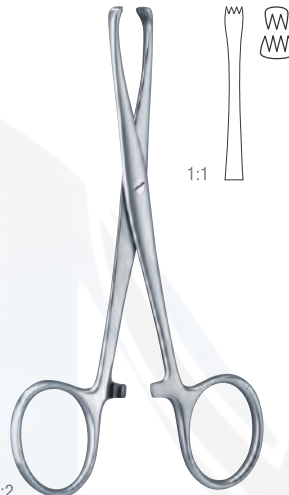

1:2  
**TUFFIER**

130 mm – 5"	04-200-130
-------------	------------



**PENNINGTON**

155 mm – 6"	04-204-155
200 mm – 8"	04-204-200



1:2  
**COLLIN**

140 mm – 5 ½"	04-207-140
---------------	------------



1:2  
**PRATT**

150 mm – 6"	04-205-150
-------------	------------



1:2  
**MARTEL**

140 mm – 5 ½"	04-208-140
---------------	------------



**Arterienklemmen**  
**Haemostatic forceps**

*Pinces hémostatiques*  
*Pinzas hemostáticas*  
*Pinze emostatiche*



**FERGUSSON**

160 mm – 6 ¼ "	04-209-160	04-210-160
200 mm – 8 "	04-209-200	04-210-200

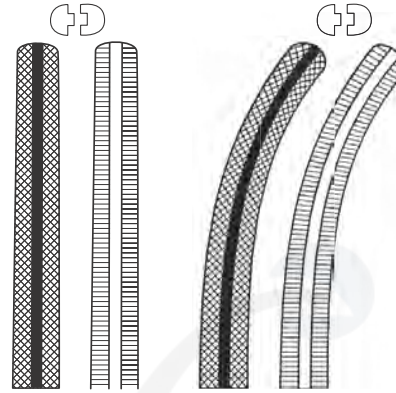

gebogen  
curved  
courbe  
curva  
curvo



**SPENCER-WELLS**

130 mm – 5 "	04-211-130	04-212-130
140 mm – 5 ½ "	04-211-140	04-212-140
155 mm – 6 "	04-211-150	04-212-150
180 mm – 7 "	04-211-180	04-212-180
200 mm – 8 "	04-211-200	04-212-200

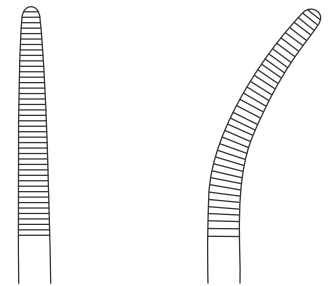

**HALSTED-MOORE**

180 mm – 7 "	04-213-180	04-214-180	04-215-180	04-216-180
210 mm – 8 ¼ "	04-217-210	04-218-210	04-219-210	04-220-210

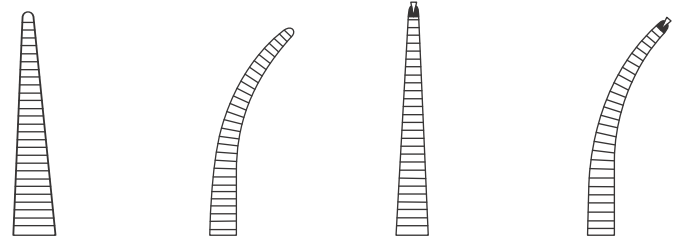

1 x 2

1 x 2

### Arterienklemmen

#### Haemostatic forceps

*Pinces hémostatiques*  
*Pinzas hemostáticas*  
*Pinze emostatiche*



#### BENG•LEA

200 mm – 8 "	04-221-200	04-222-200	04-223-200	04-224-200
260 mm – 10 ¼ "	04-221-260	04-222-260	04-223-260	04-224-260
			1 x 2	1 x 2

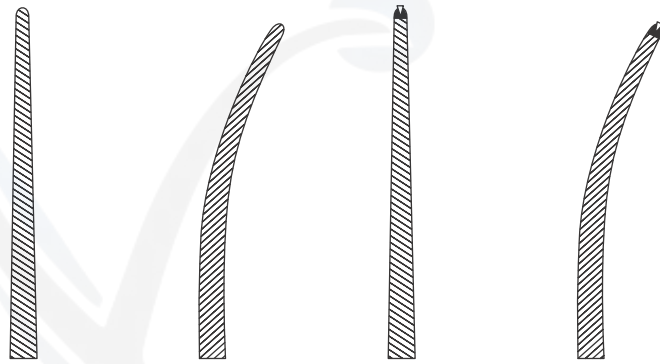

#### ADS•N

185 mm – 7 ¼ "	04-226-185	04-227-185	04-232-185	04-233-185
			1 x 2	1 x 2

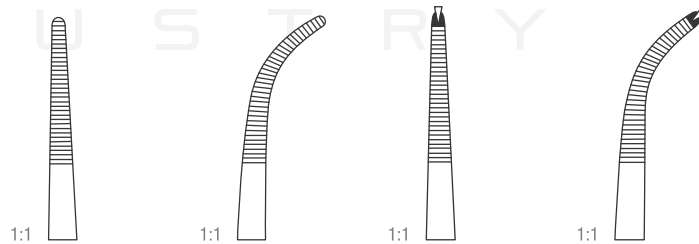

1:2

Arterienklemmen  
**Haemostatic forceps**  
*Pinces hémostatiques*  
*Pinzas hemostáticas*  
*Pinze emostatiche*



**HEISS**

200 mm – 8"	04-234-200	04-235-200	04-237-200
230 mm – 9"	04-234-230	04-235-230	04-237-230



### Arterienklemmen

#### Haemostatic forceps

*Pinces hémostatiques*

*Pinzas hemostáticas*

*Pinze emostatiche*

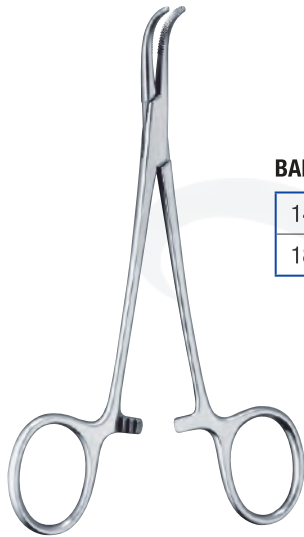

#### BABY-MIXTER

140 mm – 5 ½"	04-241-140	
180 mm – 7"		04-241-180

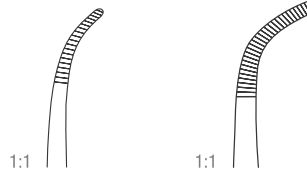

#### BABY-ADS IN

140 mm – 5 ½"	04-242-140	
180 mm – 7"		04-243-180

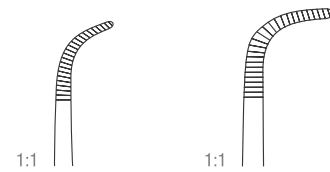

#### BABY-VERHILT

135 mm – 5 ¼"	04-245-140
---------------	------------

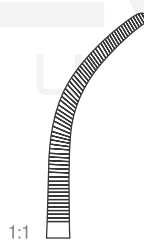

1:2

Arterienklemmen  
Haemostatic forceps

*Pinces hémostatiques*  
*Pinzas hemostáticas*  
*Pinze emostatiche*

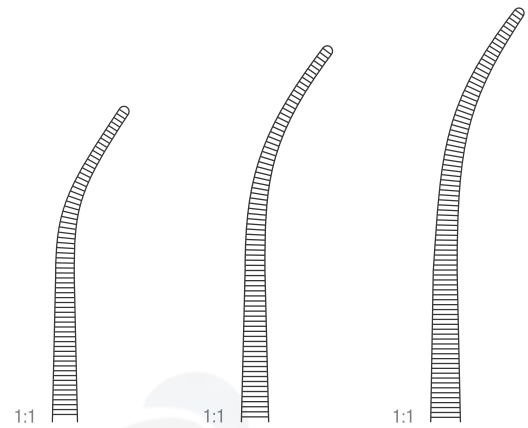
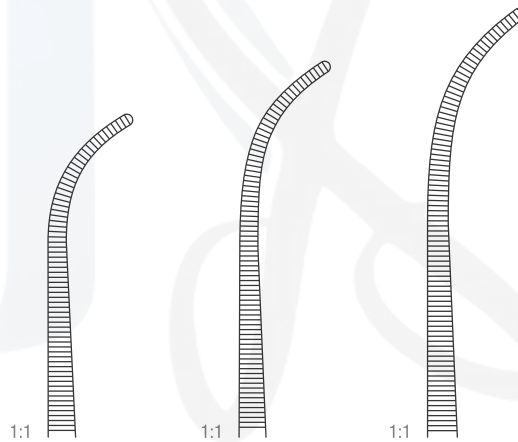

Fig. 1	Fig. 1	Fig. 1
195 mm – 7 ¾ "	225 mm – 8 ¾ "	245 mm – 9 ¾ "
04-247-190	04-247-220	04-247-240



**KELLY-FRASER**

Fig. 2	Fig. 2	Fig. 2
190 mm – 7 ½ "	220 mm – 8 ¾ "	240 mm – 9 ½ "
04-249-190	04-249-220	04-249-240

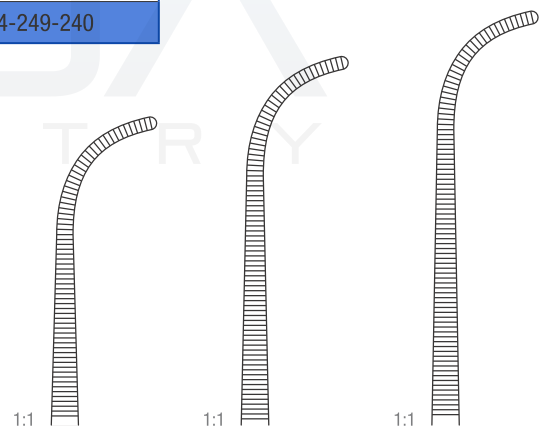

Fig. 3	Fig. 3	Fig. 3
185 mm – 7 ¼ "	215 mm – 8 ½ "	235 mm – 9 ¼ "
04-251-190	04-251-220	04-251-240

### Arterienklemmen

#### Haemostatic forceps

*Pinces hémostatiques*

*Pinzas hemostáticas*

*Pinze emostatiche*



1:2

#### SCHNIDT

1:1

1:1

190 mm – 7 ½ "

04-252-190

04-253-190



#### T•ENNIS

210 mm – 8 ¼ "

04-258-210

04-259-210

04-260-210

04-261-210

260 mm – 10 ¼ "

04-258-260

04-259-260

04-260-260

04-261-260

1 x 2

1 x 2

**Arterienklemmen**  
**Haemostatic forceps**

*Pinces hémostatiques*  
*Pinzas hemostáticas*  
*Pinze emostatiche*

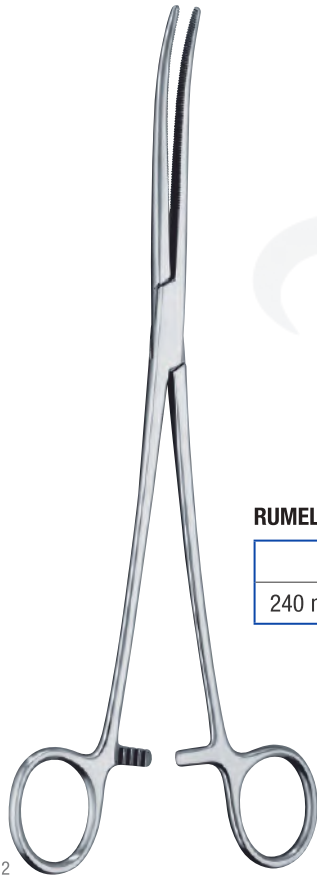

1:2

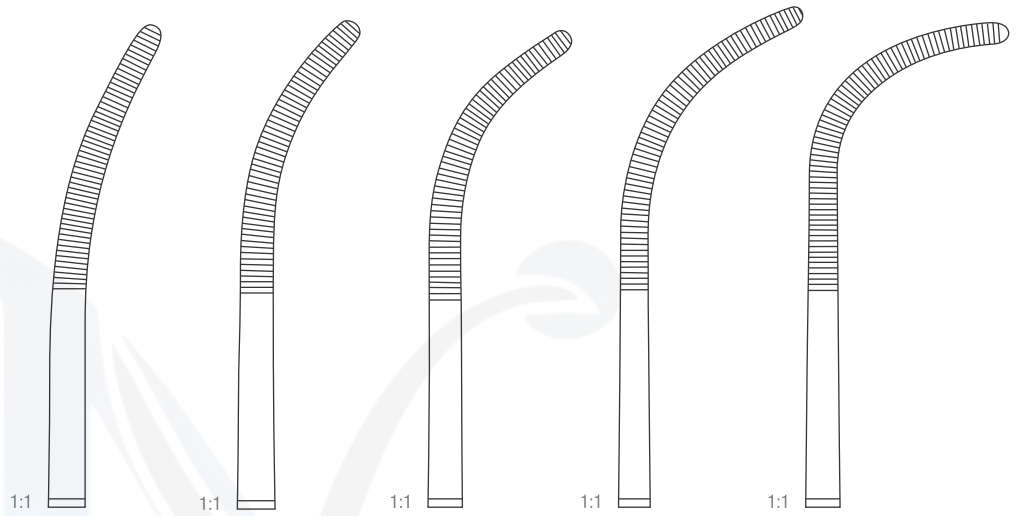

**RUMEL**

	Fig. 1	Fig. 2	Fig. 3	Fig. 4	Fig. 5
240 mm – 9 1/2"	04-265-001	04-265-001	04-265-003	04-265-004	04-265-005

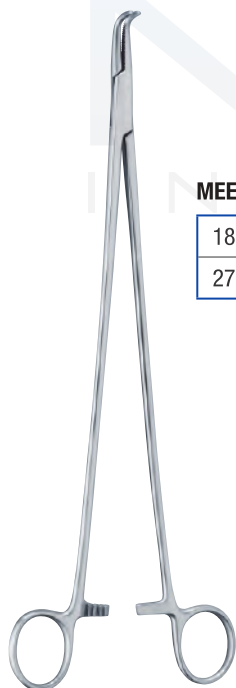

**MEEKER**

180 mm – 7"	04-266-180
275 mm – 10 3/4"	04-266-280

gebogen, 90°  
curved, 90°  
courbe, 90°  
curva, 90°  
curve, 90°

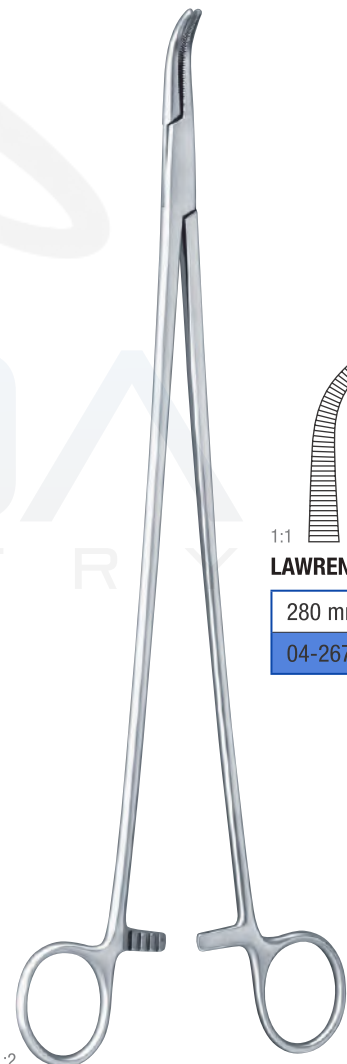

1:2

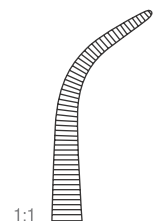

1:1

**LAWRENCE**

280 mm – 11"	04-267-280
--------------	------------

Präparier- und ligaturklemmen  
*Dissecting and ligature forceps*

*Pinces à disséquer et à sutures*  
*Pinzas para preparación y suturas*  
*Pinze per preparazioni e suture*



• VERH • LT-  
GEISSEND • ERFER

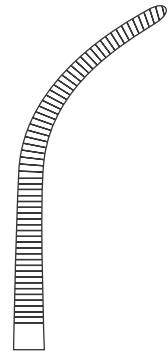
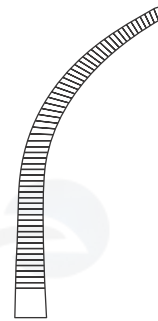
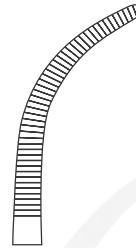
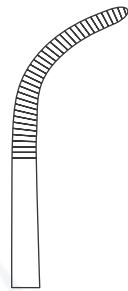

	Fig. 1	Fig. 2	Fig. 3	Fig. 4
210 mm – 8 ¼ "	13-469-001	13-469-002	13-469-003	13-469-004
270 mm – 10 ¾ "	312-423-010	312-423-020	312-423-030	312-423-040

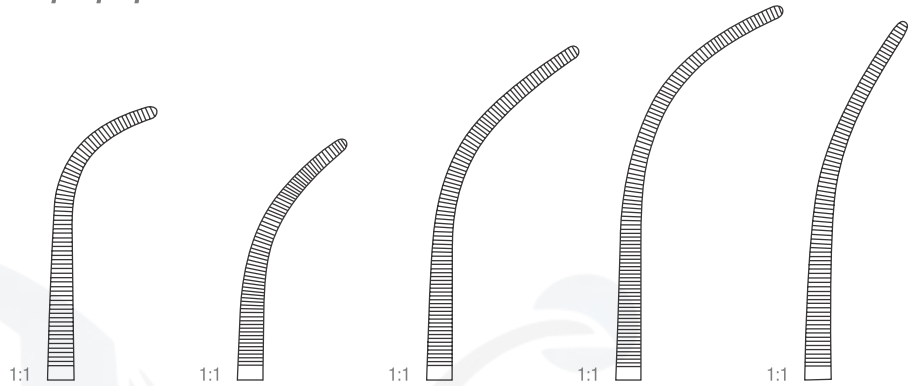
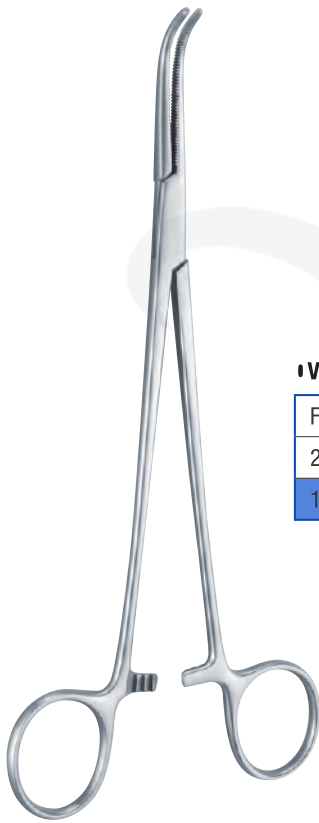

	Fig. 5	Fig. 6	Fig. 7
210 mm – 8 ¼ "	13-469-005	13-469-006	13-469-007
270 mm – 10 ¾ "	312-423-050	312-423-060	312-423-070



Präparier- und ligaturklemmen  
*Dissecting and ligature forceps*

*Pinces à disséquer et à sutures*  
*Pinzas para preparación y suturas*  
*Pinze per preparazioni e suture*



• VERH • LT-FIN •

Fig. 0	Fig. 1	Fig. 2	Fig. 3	Fig. 6
215 mm – 8 ½ "	210 mm – 8 ¼ "	220 mm – 8 ¾ "	230 mm – 9 "	225 mm – 8 ¾ "
13-471-000	13-471-001	13-471-002	13-471-003	13-471-006

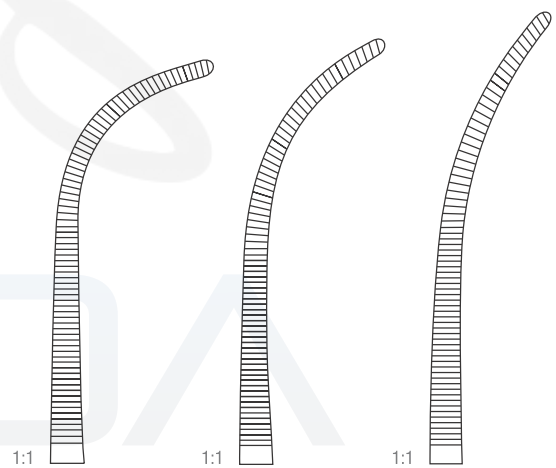

• VERH • LT

Fig. 0	Fig. 1	Fig. 6
295 mm – 8 ½ "	295 mm – 8 ½ "	300 mm – 8 ¾ "
312-425-000	312-425-001	312-425-006

### Präparier- und ligaturklemmen Dissecting and ligature forceps

*Pinces à disséquer et à sutures*  
*Pinzas para preparación y suturas*  
*Pinze per preparazioni e suture*

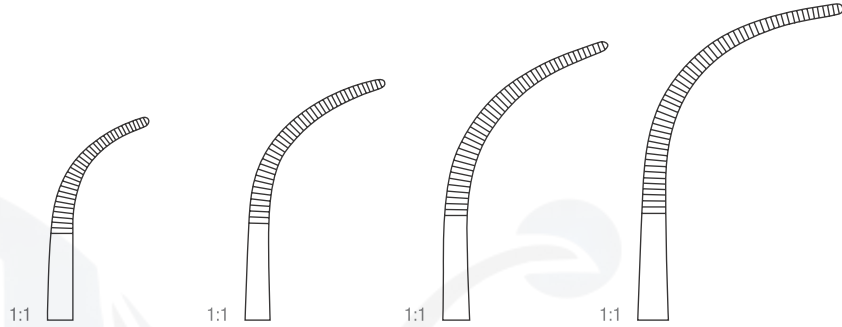

#### • VERH • LT-M • DIFIZIERT

185 mm – 7 ¼ "	205 mm – 8 "	210 mm – 8 ¼ "	215 mm – 8 ½ "
413-413-010	413-413-020	413-413-030	413-413-040

S-förmig gebogen  
S-curved  
courbe en S  
curva en S  
curve a forma di S



#### • VERH • LT-MIXTER

210 mm – 8 ¼ "	413-423-210
----------------	-------------

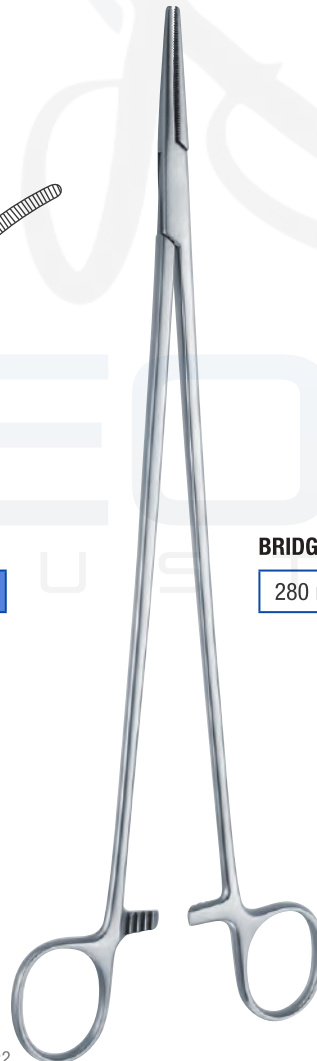
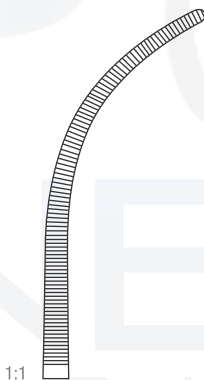

#### BRIDGE

280 mm – 11 "	312-452-275	04-267-275
---------------	-------------	------------

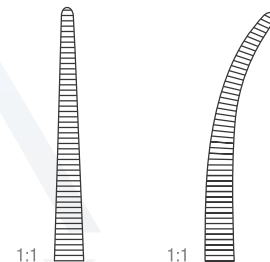

1:2

1:2

Präparier- und Ligaturklemmen  
*Dissecting and ligature forceps*

*Pinces à disséquer et à sutures*  
*Pinzas para preparación y suturas*  
*Pinze per preparazioni e suture*

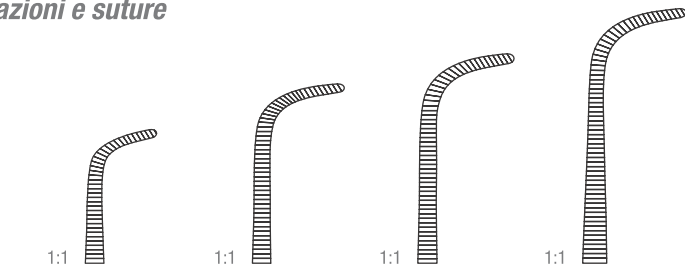

**GEMINI**

130 mm – 5 "	160 mm – 6 ¼ "	180 mm – 7 "	200 mm – 8 "
04-268-130	04-268-160	04-268-180	04-268-200

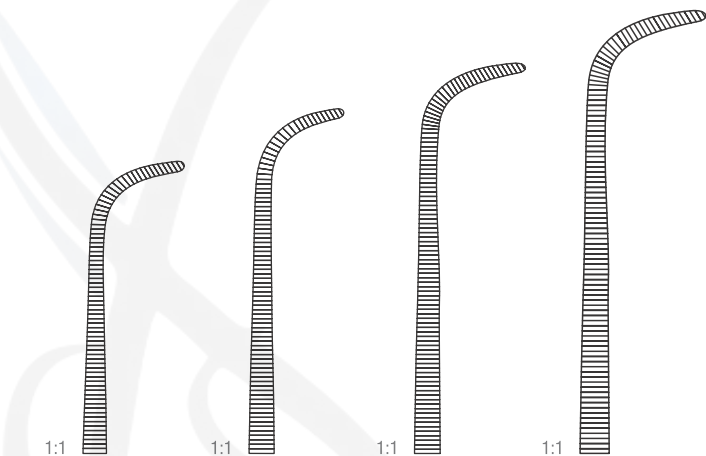

230 mm – 9 "	250 mm – 9 ¾ "	280 mm – 11 "	350 mm – 14 "
04-268-230	04-268-250	04-268-280	04-268-350

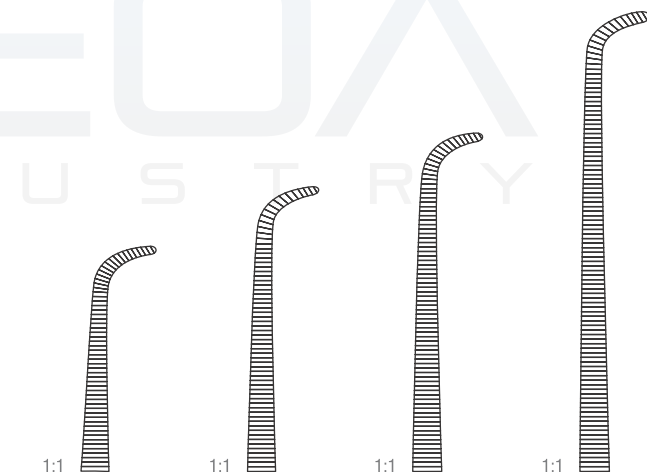

**GEMINI-MINI**

180 mm – 7 "	220 mm – 8 ¾ "	250 mm – 9 ¾ "	280 mm – 11 "
04-269-180	04-269-220	04-269-250	04-269-280

Präparier- und ligaturklemmen  
*Dissecting and ligature forceps*

*Pinces à disséquer et à sutures*  
*Pinzas para preparación y suturas*  
*Pinze per preparazioni e suture*



**ZENKER**

295 mm – 11 ½ "

04-271-010

04-271-020

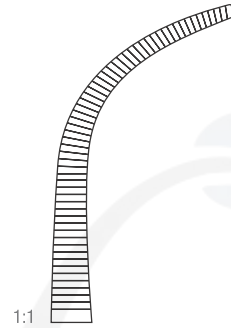
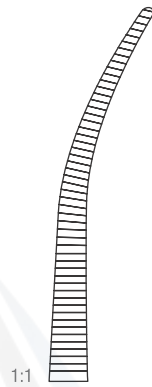

**ROBERTS**

220 mm – 8 ¾ "

04-272-220

04-273-220



Präparier- und ligaturklemmen  
*Dissecting and ligature forceps*

*Pinces à disséquer et à sutures*  
*Pinzas para preparación y suturas*  
*Pinze per preparazioni e suture*



**MIXTER**

140 mm – 6 "	04-274-140
155 mm – 6 "	04-274-160
190 mm – 7 ½ "	04-274-180
230 mm – 9 "	04-274-230

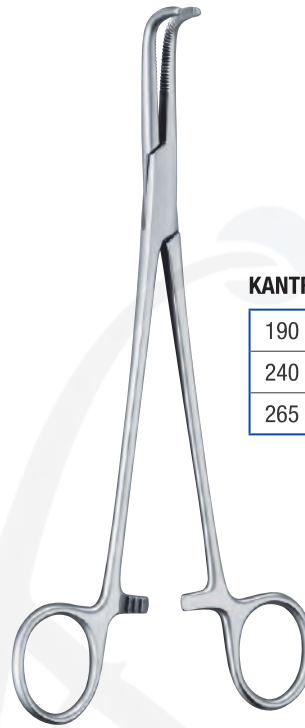
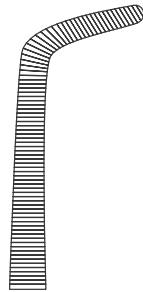

**KANTR+WITZ**

190 mm – 7 ½ "	04-275-190
240 mm – 9 ½ "	04-275-240
265 mm – 10 ½ "	04-275-265

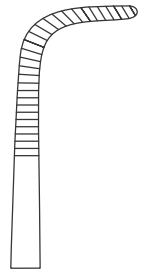

**MIXTER**

230 mm – 9 "	04-277-230
--------------	------------

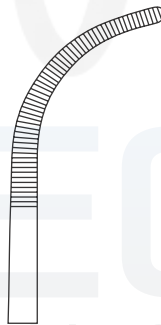

Präparier- und ligaturklemmen  
*Dissecting and ligature forceps*

*Pinces à disséquer et à sutures*  
*Pinzas para preparación y suturas*  
*Pinze per preparazioni e suture*



**MIXTER**

230 mm – 9"

04-278-230

1:1

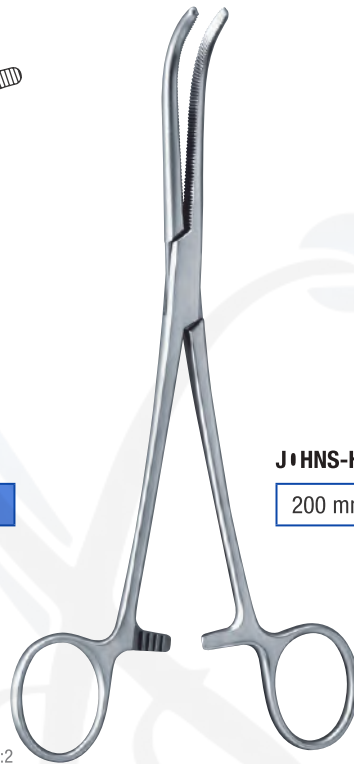
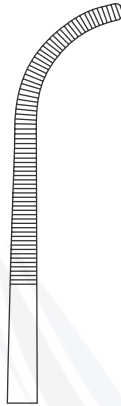

**J•HNS-H•PKINS**

200 mm – 8"

04-279-200

1:1

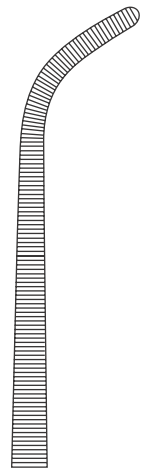

1:2



**MIXTER-1'SHAUGNESSY**

155 mm – 6"

04-283-150

190 mm – 7 ½"

04-283-190

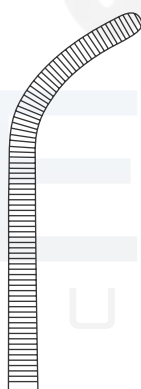

NEOA  
INDUSTRY

Präparier- und ligaturklemmen  
*Dissecting and ligature forceps*

*Pinces à disséquer et à sutures*  
*Pinzas para preparación y suturas*  
*Pinze per preparazioni e suture*



**WICKSTRÖM**

210 mm – 8 ¼ "	04-284-210
----------------	------------

240 mm – 9 ½ "	04-284-240
----------------	------------

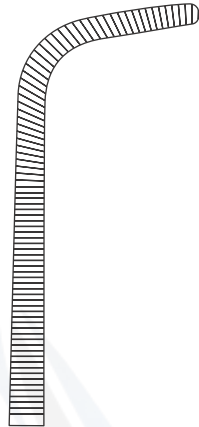

**CRAFORD**

180 mm – 7 "	04-285-180
--------------	------------

240 mm – 9 ½ "	04-286-240
----------------	------------

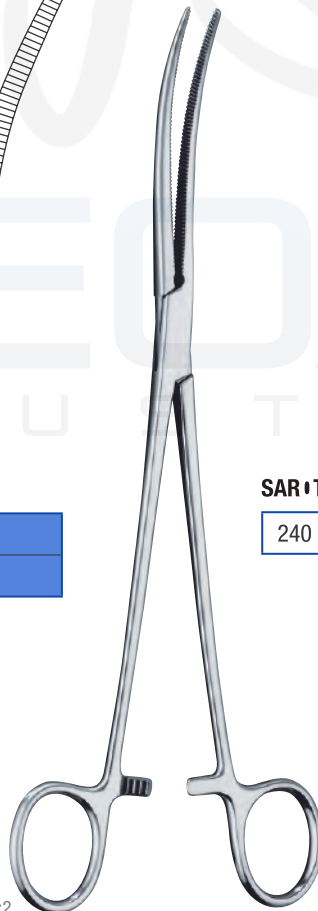
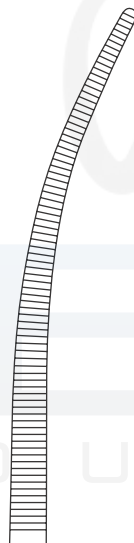

**SART**

240 mm – 9 ½ "	04-287-240	04-288-240
----------------	------------	------------

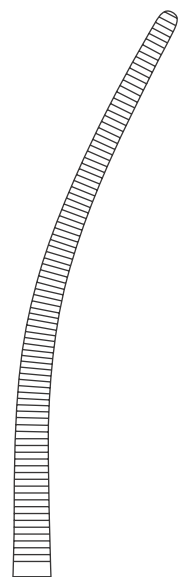

Präparier- und ligaturklemmen  
*Dissecting and ligature forceps*

*Pinces à disséquer et à sutures*  
*Pinzas para preparación y suturas*  
*Pinze per preparazioni e suture*

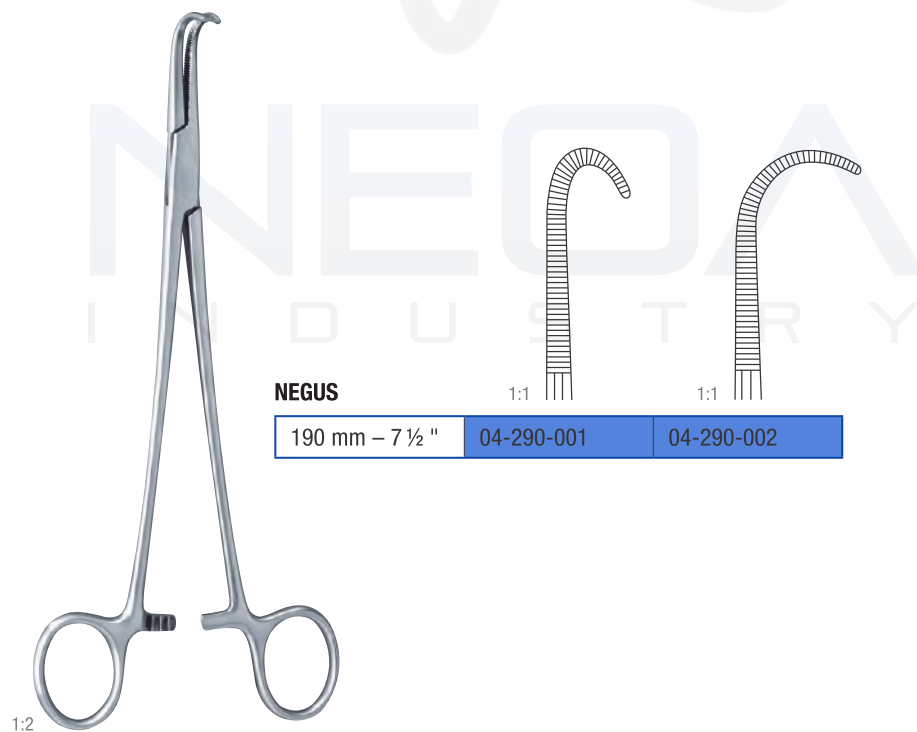



### Gallenkanal- und nierenstiellklemmen

#### Kidney pedicle and gall duct forceps

*Pinces pour pédicules renaux et voies biliaires*  
*Pinzas para pedículos renales y conductos biliares*  
*Pinze per peduncoli renali e vie biliari*



**L•WER** 1:1  

180 mm – 7 "	04-291--180
--------------	-------------

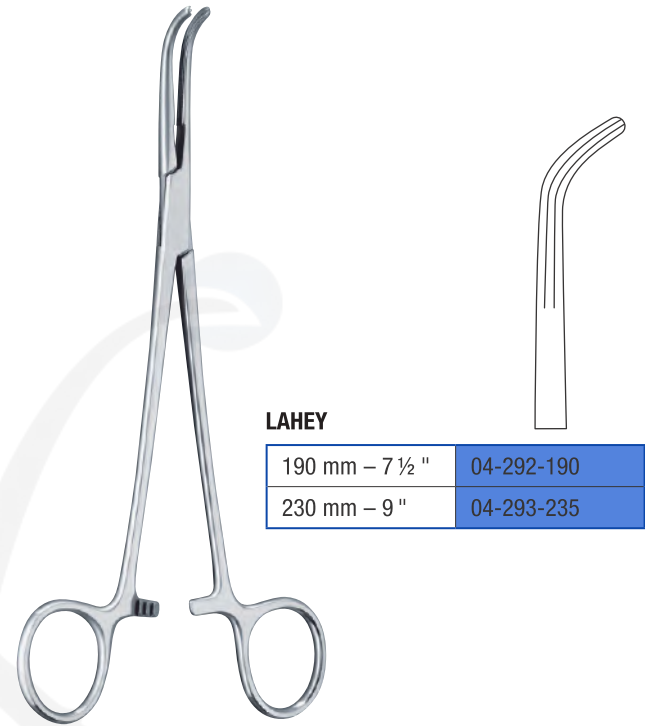

**LAHEY**  

190 mm – 7½ "	04-292-190
230 mm – 9 "	04-293-235



**MCQUIGG-MIXTER** 1:1  

220 mm – 8¾ "	04-294-220
---------------	------------

1:2

### Gallenkanal- und nierenstiellklemmen

#### *Kidney pedicle and gall duct forceps*

*Pinces pour pédicules renaux et voies biliaires*  
*Pinzas para pedículos renales y conductos biliares*  
*Pinze per peduncoli renali e vie biliari*

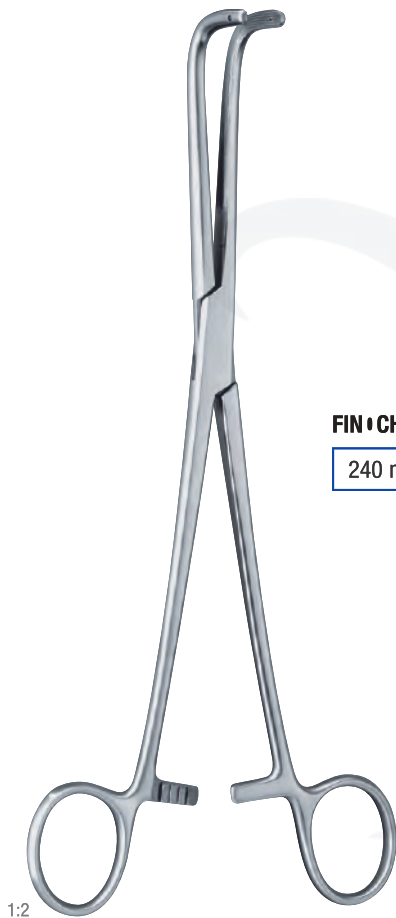

**FIN CHIETT**

240 mm – 9 ½ "

04-295-240

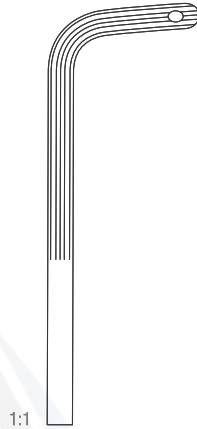

1:1



**MIXTER**

220 mm – 8 ¾ "

04-296-230

250 mm – 9 ¾ "

04-297-250

280 mm – 11 "

04-298-280

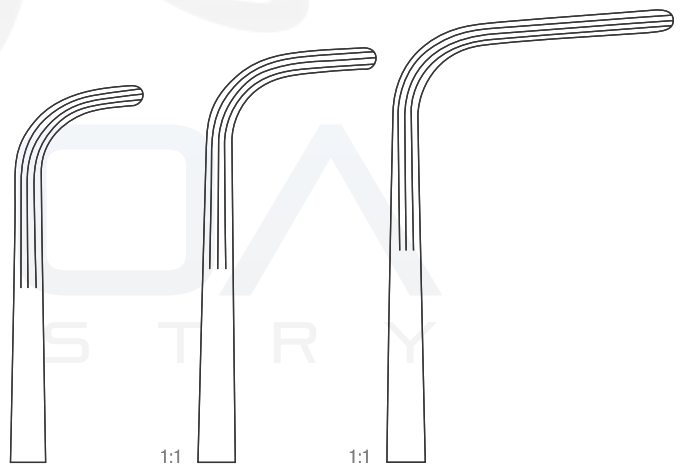

1:1

1:1

1:1

### Gallenkanal- und nierenstielflemmen Kidney pedicle and gall duct forceps

*Pinces pour pédicules renaux et voies biliaires*  
*Pinzas para pedículos renales y conductos biliares*  
*Pinze per peduncoli renali e vie biliari*

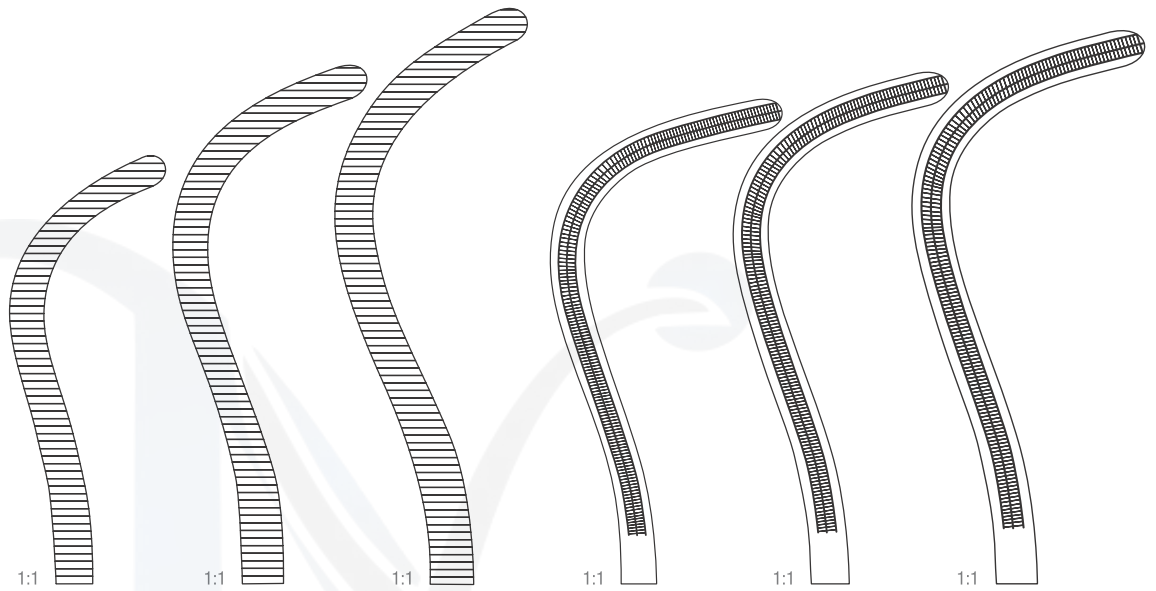

**GUY•N**

			Atrauma	Atrauma	Atrauma
200 mm – 8"	220 mm – 8 ¾"	240 mm – 9 ½"	225 mm – 9"	230 mm – 9"	240 mm – 9 ½"
04-300-200	04-300-220	04-300-240	04-301-225	04-301-230	04-301-240

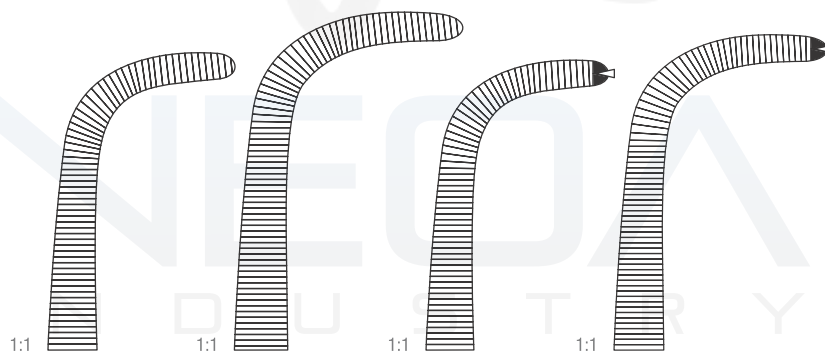

**GRAY**

Fig. 1	Fig. 2	Fig. 1	Fig. 2
220 mm – 8 ¾"	230 mm – 9"	220 mm – 8 ¾"	230 mm – 9"
04-302-220	04-302-230	04-303-220	04-303-230

1 x 2

1 x 2

### Nierenstielklemmen

#### Kidney pedicle forceps

*Pinces pour pédicules renaux*  
*Pinzas para pediculos renales*  
*Pinze per peduncoli renali*



**HERRICK** 1:1  
 230 mm – 9" 04-304-230



**GUYON** 1:1  
 230 mm – 9" 04-305-230

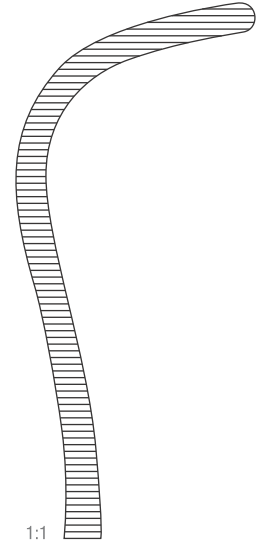

**MAY-GUYON** 1:1  
 230 mm – 9" 04-306-230



Klemmzangen – Peritoneumklemmen  
*Clamp forceps – Peritoneal forceps*

*Pinces-clamps – Pinces pour le péritoine*  
*Pinzas-clamps – Pinzas para peritóneo*  
*Pinze per peritoneo*



**FAURE**

1:1

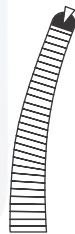

200 mm – 8"

04-307-210

04-308-210

1 x 2

1 x 2

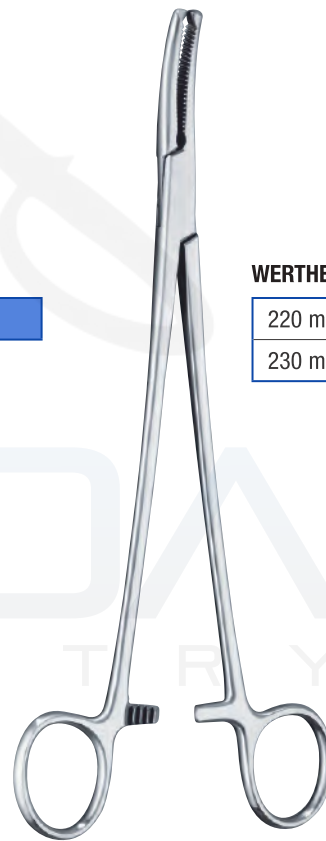

**WERTHEIM**

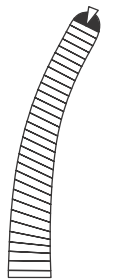

220 mm – 8 ¾"

04-309-220

230 mm – 9"

04-310-230

1 x 2

NEOA  
INDUSTRY

Klemmzangen – Peritoneumklemmen  
*Clamp forceps – Peritoneal forceps*

*Pinces-clamps – Pincés pour le péritoine*  
*Pinzas-clamps – Pinzas para peritóneo*  
*Pinze per peritoneo*

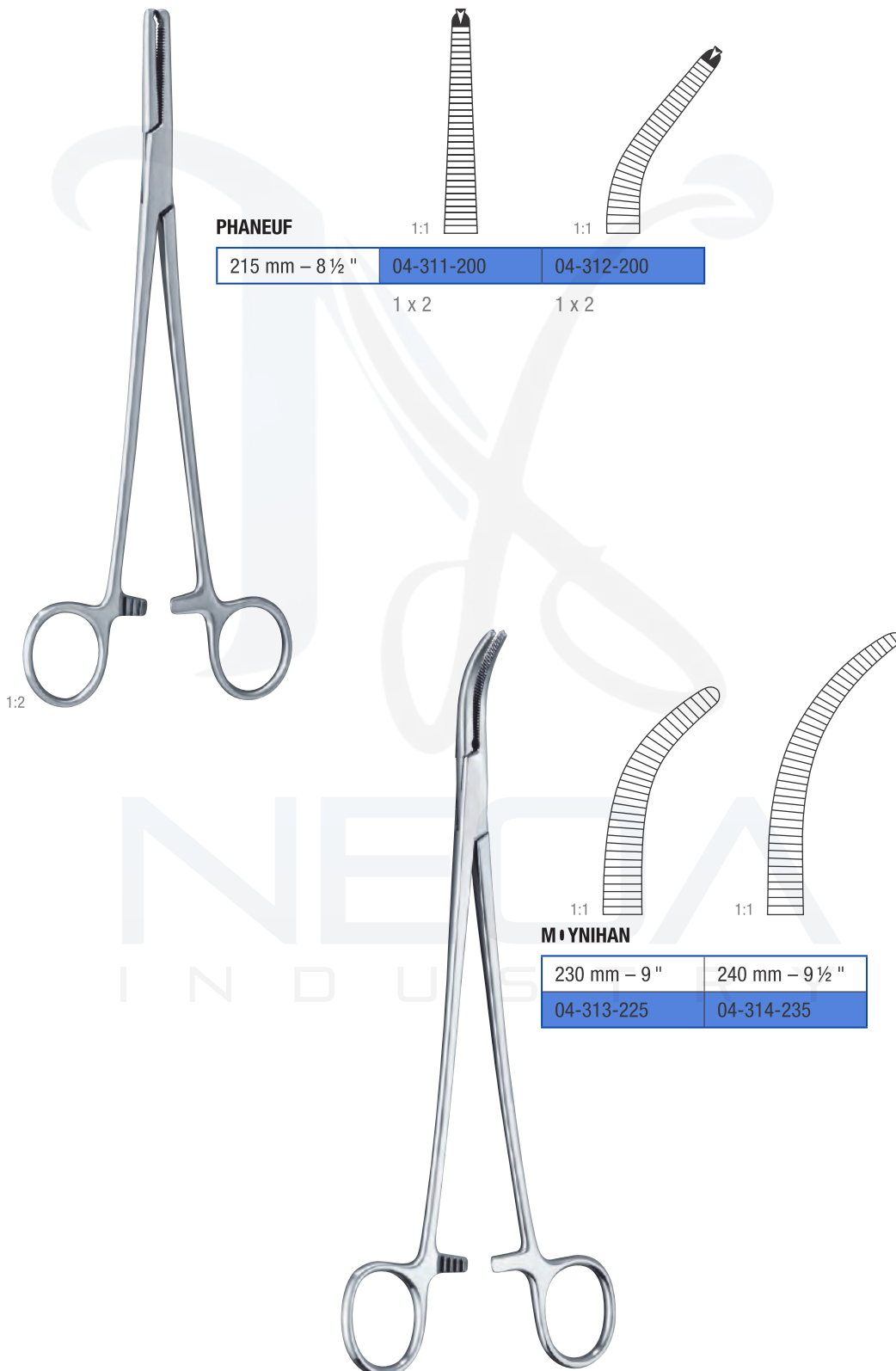

Klemmzangen – Peritoneumklemmen  
 Clamp forceps – Peritoneal forceps

*Pinces-clamps – Pinces pour le péritoine*  
*Pinzas-clamps – Pinzas para peritóneo*  
*Pinze per peritoneo*

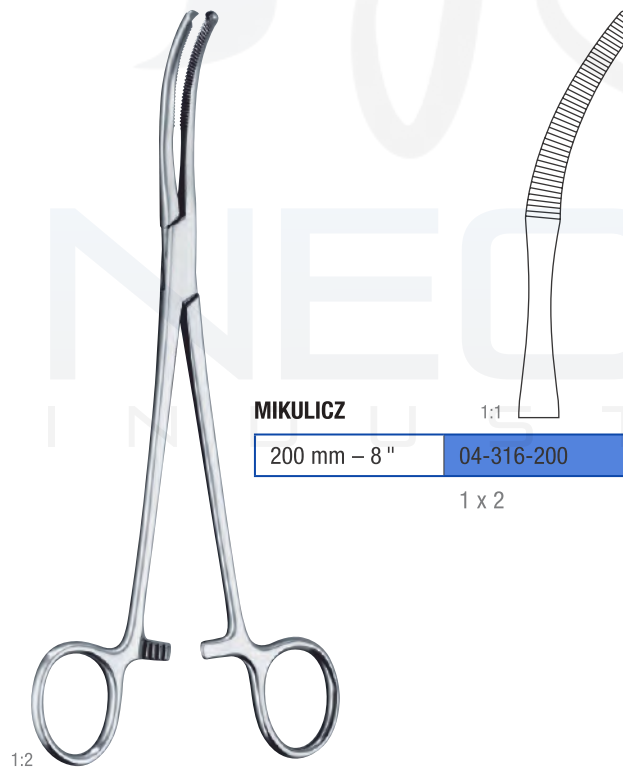
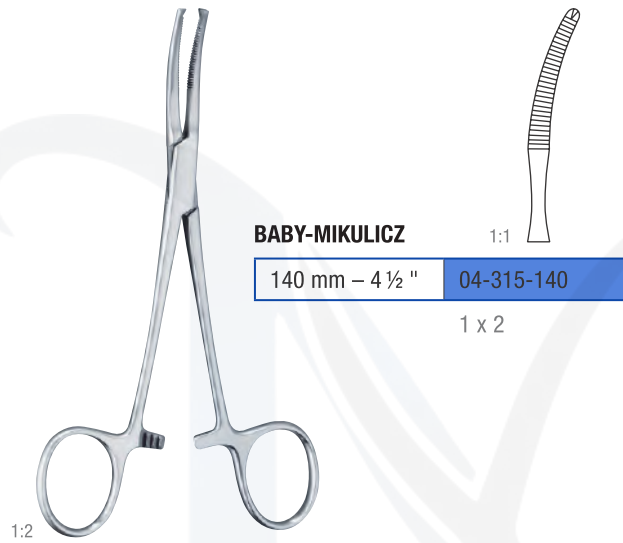

Klemmzangen – Peritoneumklemmen  
 Clamp forceps – Peritoneal forceps

*Pinces-clamps – Pinces pour le péritoine*  
*Pinzas-clamps – Pinzas para peritóneo*  
*Pinze per peritoneo*



**MAING+T**

205 mm – 8 " 04-317-200

250 mm – 9 ¾ " 04-317-250

1 x 2



**WERTHEIM**

250 mm – 9 ¾ " 04-318-250

1:1

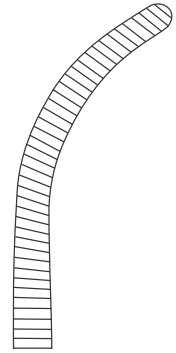

1:2

1:1

**WERTHEIM-CULLEN**

215 mm – 8 ½ " 04-319-210

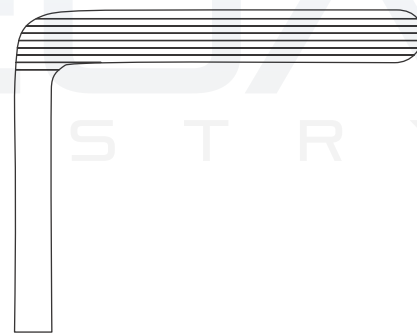

1:2



Hysterektomieklemmen  
*Hysterectomy forceps*

*Pinces pour hystérectomie*  
*Pinzas para histerectomía*  
*Pinze per isterectomia*



**HEANEY**

195 mm – 7 ¾ "	04-320-195	04-321-195
210 mm – 8 ¼ "	04-320-210	04-321-210
230 mm – 9 "	04-320-230	04-321-230

Hysterektomieklemmen  
*Hysterectomy forceps*

*Pinces pour hystérectomie*  
*Pinzas para histerectomía*  
*Pinze per isterectomia*



**HEANEY-BALLENTINE**

1:1

1:1

210 mm – 8 ¼ "

04-322-210

04-323-210

1:2

**Parametriumklemmen**  
**Parametrium forceps**

*Pinces parametrium*  
*Pinzas parametrium*  
*Pinze parametrium*

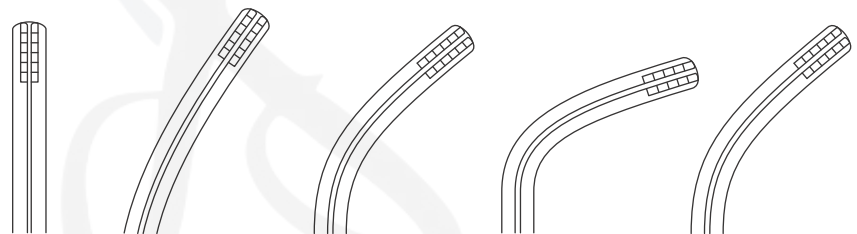

210 mm – 8¼"	04-324-210	04-325-210	04-327-210	04-329-210	04-331-210
240 mm – 9½"	04-324-240	04-325-240	04-327-240	04-329-240	04-331-240
260 mm – 10¼"	04-324-260	04-325-260	04-327-260	04-329-260	04-331-260
300 mm – 12"	04-324-300	04-325-300	04-327-300	04-329-300	04-331-300
350 mm – 13¾"	04-324-350	04-325-350	04-327-350	04-329-350	04-331-350

S-förmig gebogen  
S-curved  
coube en S  
curva en S  
curva a forma di S

lungenfasszangen  
**Lung grasping forceps**

*Pinces-clamps pour poumons*  
*Pinzas para coger pulmones*  
*Pinza per afferrare il polmone*

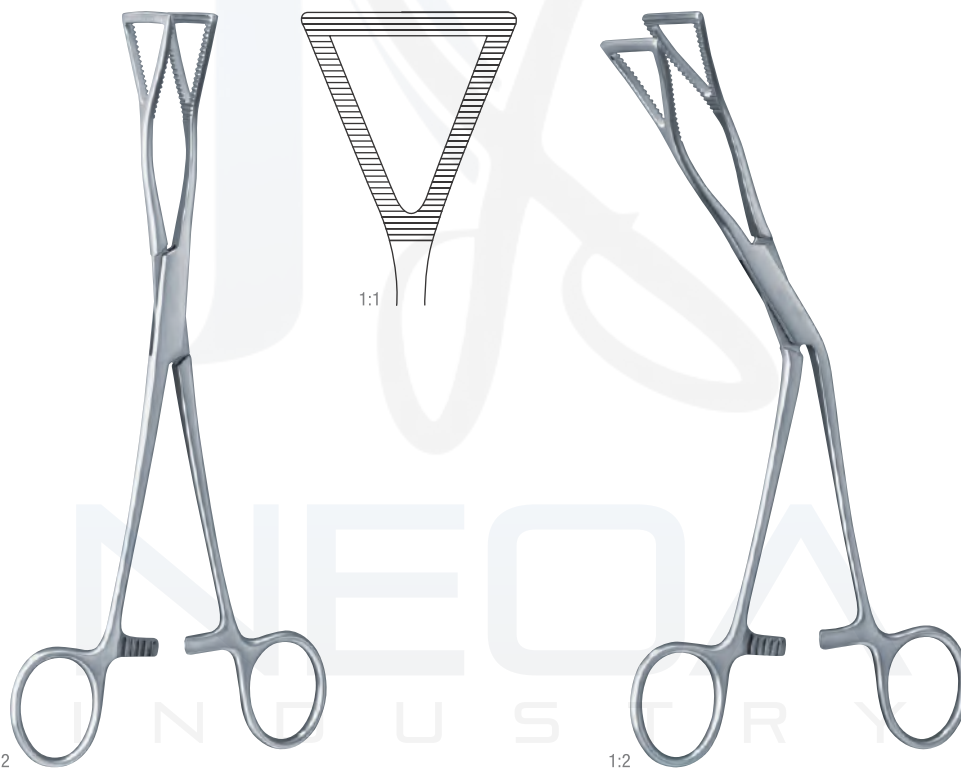

**L • VELACE**

1:2

1:2

200 mm – 8"

04-332-200

04-333-200

**Bronchus- und gefäßklemmen**  
**Bronchus and vascular clamps**

*Pinces vasculaires et pour bronches*  
*Pinzas vasculares y bronquiales*  
*Pinze vascolari e per bronchi*

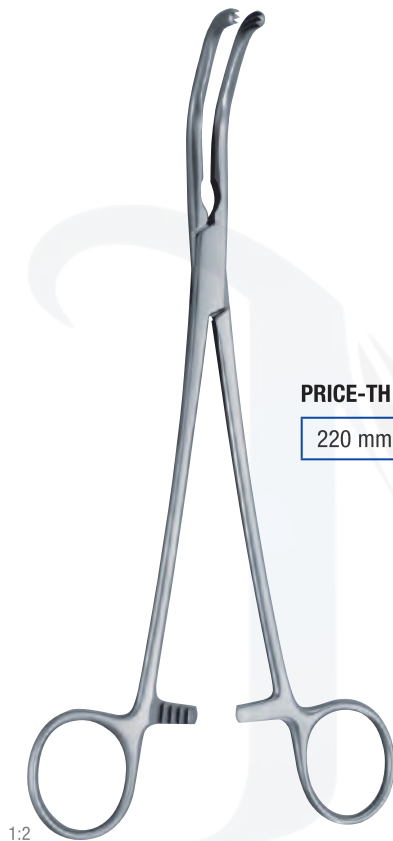

1:2

**PRICE-THOMAS**

220 mm – 8 3/4 "

04-340-220

1:1

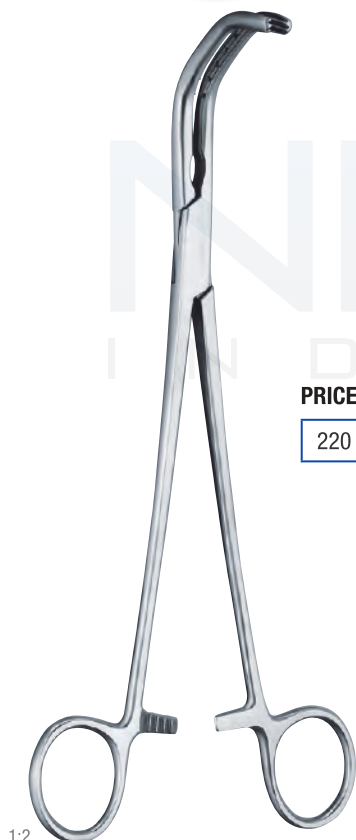

1:2

**PRICE-THOMAS**

220 mm – 8 3/4 "

04-337-220

04-339-220

1:1

1:1

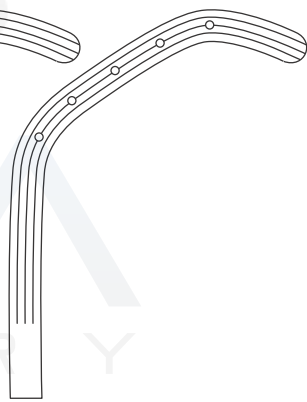
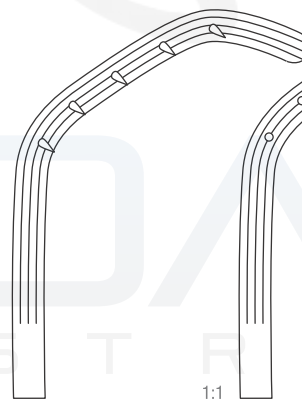

Stifte links  
Pins left  
Goupilles à gauche  
Pernos izquierda  
Perni a sinistra

Stifte rechts  
Pins right  
Goupilles à droit  
Pernos derecha  
Perni a destra

### Bronchus- und gefäßklemmen

#### Bronchus and vascular clamps

*Pinces vasculaires et pour bronches*  
*Pinzas vasculares y bronquiales*  
*Pinze vascolari e per bronchi*

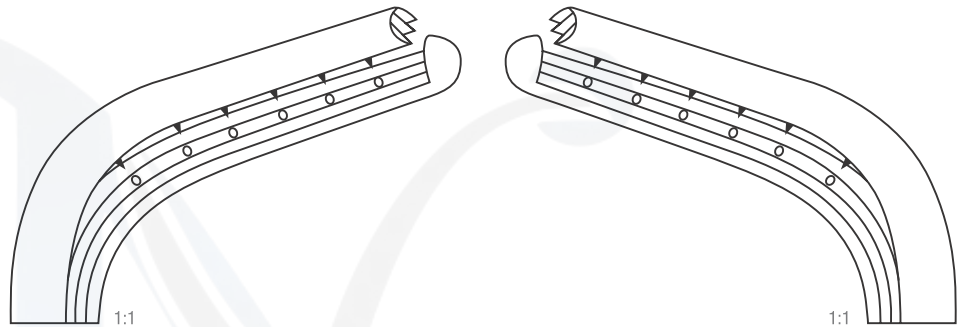

**SARIT**

230 mm – 9"

04-341-230

04-342-230

Stifte links  
 Pins left  
 Goupilles à gauche  
 Pernos izquierda  
 Perni a sinistra

Stifte rechts  
 Pins right  
 Goupilles à droit  
 Pernos derecha  
 Perni a destra



**SEMB**

240 mm – 9 ½"

04-343-230

04-344-230

**Bronchus- und gefäßklemmen**  
**Bronchus and vascular clamps**

*Pinces vasculaires et pour bronches*  
*Pinzas vasculares y bronquiales*  
*Pinze vascolari e per bronchi*



**BABY-SATINSKY**

1:1

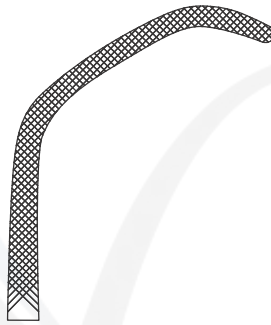

150 mm – 6 "

356-321-150



**SATINSKY**

1:1

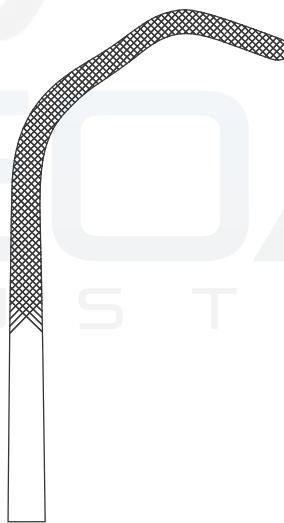

1:1

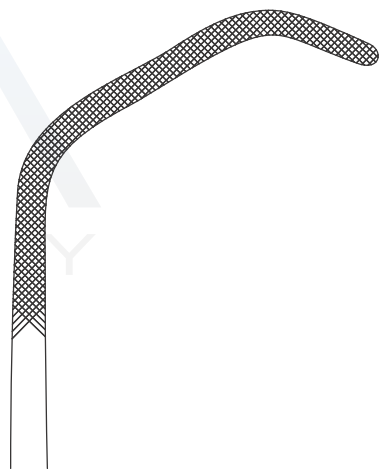

	Fig. 1	Fig. 1	Fig. 2	Fig. 2
265 mm – 10 ½ "	04-345-260	04-346-260	04-347-260	04-348-260

S-förmig gebogen  
S-curved  
coube en S  
curva en S  
curva a forma di S

S-förmig gebogen  
S-curved  
coube en S  
curva en S  
curva a forma di S

Tuchklemmen  
Towel forceps

*Pinces à champs*  
*Pinzas de campo*  
*Pinze fissateli*



**BERNHARD**

100 mm – 4 "	04-349-100
120 mm – 4 ¾ "	04-349-120
140 mm – 5 ½ "	04-349-140
165 mm – 6 ½ "	04-349-160
180 mm – 7 "	04-349-180



**BACKHAUS**

80 mm – 3 "	04-350-080
90 mm – 3 ½ "	04-350-090
110 mm – 4 ¼ "	04-350-110
130 mm – 5 "	04-350-130
150 mm – 6 "	04-350-150



**RIEDER**

130 mm – 5 "	04-351-130
150 mm – 6 "	04-351-150



1:2

110 mm – 4 "	04-352--110
--------------	-------------

mit Schlauchhalter  
with clip for tube  
avec porte-tuyeau  
con soporte de tubo  
con supporto per tubo



Tuchklemmen  
Towel forceps

Pinces à champs  
Pinzas de campo  
Pinze fissateli



**R•BIN** 1:2

135 mm – 5¼"	04-353-135
--------------	------------

mit Schlauchhalter bis 5 mm Ø  
with clip for tube up to 5 mm Ø  
avec porte-tuyeau à 5 mm Ø  
con soporte de tubo hasta 5 mm Ø  
con supporto per tubo fino a 5 mm Ø



**J•NES**

50 mm – 2"	04-354-060
90 mm – 3½"	04-354-090



**SCHAEDEL** 1:2

90 mm – 3½"	04-355-090	17-220-090
-------------	------------	------------

gerade  
straight  
droit  
recta  
retto



**D•YEN** 1:2

180 mm – 7"	04-356-180
-------------	------------



**L•RNA**

100 mm – 4"	04-357-100
130 mm – 5"	04-357-130

### Tuchklemmen

#### Towel forceps

*Pinces à champs*  
*Pinzas de campo*  
*Pinze fissateli*



**LANE**

130 mm – 5 "	04-358-130
150 mm – 6 "	04-358-150
200 mm – 8 "	04-358-200



**T•H•KU-JAPAN**

100 mm – 4 "	04-359-100
130 mm – 5 "	04-359-130

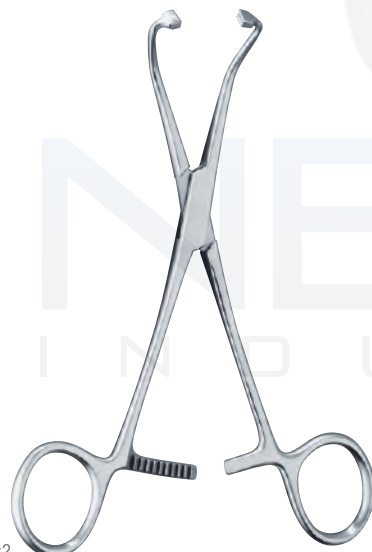

1:2

**PEERS-BERTRAM**

145 mm – 5 ¾ "	04-359-140
----------------	------------



110 mm – 4 ⅜ "	04-360-110
130 mm – 5 "	04-360-130

für Papierabdeckung  
 for paper clothes  
 pour couvertures en papier  
 para paños de papel  
 per copertura di carta

### Schlauchklemmen

#### Tubing clamps

Presse-tubes  
Pinzas para tubos  
Pinze serratubi



150 mm – 6 "	04-361-150
160 mm – 7 "	04-361-180
190 mm – 8 "	04-361-200

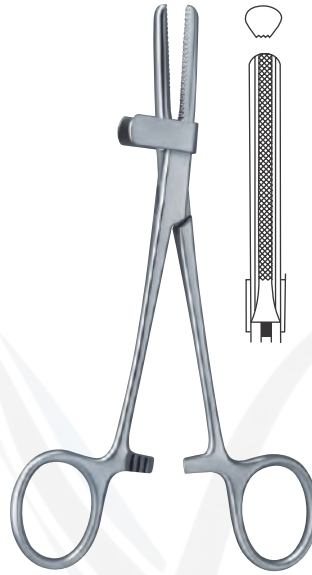

150 mm – 6 "	04-362-150
180 mm – 7 "	04-362-180
200 mm – 8 "	04-362-200

mit Schutzbügel  
with protection  
avec protection  
con protector  
con protettore



165 mm – 6 ½ "	13-984-165
180 mm – 7 "	13-984-180

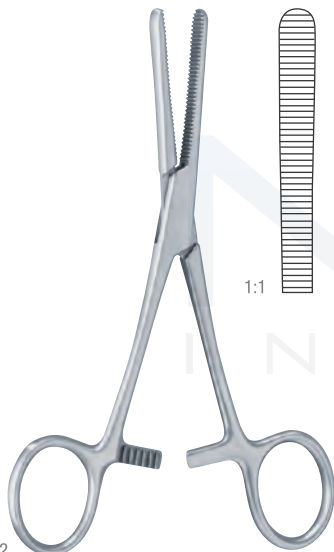

1:2

**KLINIKUM-BERLIN**

145 mm – 5 ¾ "	04-363-145
----------------	------------

mit extra langer Sperre  
with extra long ratchet  
avec crémaillère extra longue  
con cremallera extra larga  
con cremagliera extra lunga



1:2

**GUNNAR**

185 mm – 7 ¼ "	04-364-180
----------------	------------



Manufacturer & Supplier Premium Quality Surgical, Dental, Podiatry, Pet Grooming and Beauty Care Instruments.

**USA Address:**

 5900 Balcones Drive # 16244  
Austin TX, USA 78731.  
 +1 (917) 773 3694  
 **uk:** +44 7871 836765  
 info@neoaindustry.com  
neoaindustry4@gmail.com  
 www.neoaindustry.com

**Main Head Office:**

 Roars Road New Miana Pura  
West, Sialkot 51310 Pakistan.  
 +92 322 5587688  
 +92 322 5587688  
 info@neoaindustry.com  
neoaindustry4@gmail.com  
 www.neoaindustry.com

