

» Wundhaken

» Retractors

» Ecarteurs

» Separadores

» Divaricatori

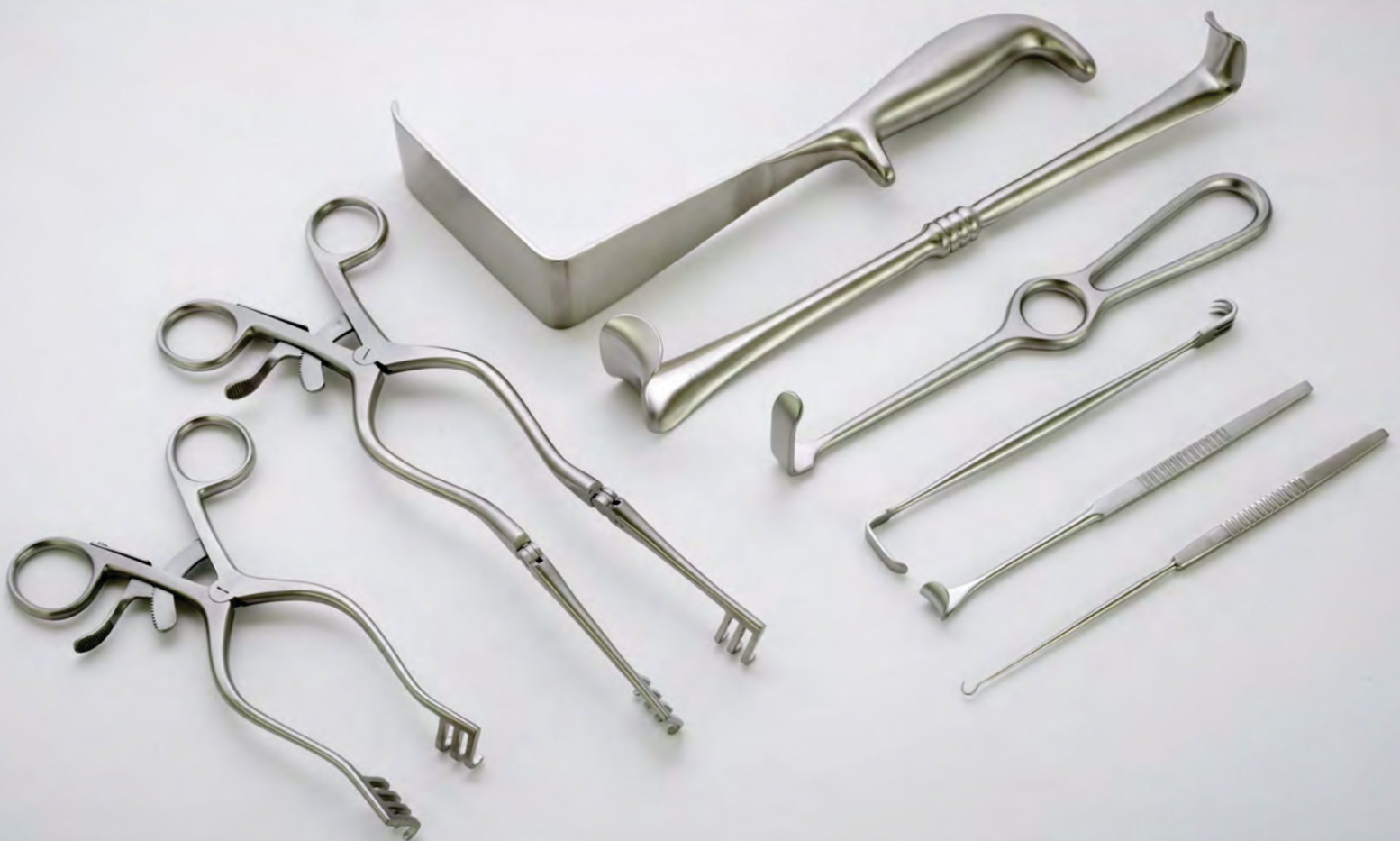

Nasenhäkchen
Nasal hooks

Crochets nasales
Ganchitos nasales
Uncini nasali



KILNER 1:2

150 mm – 6 "
08-101-150



JOSEPH 1:2

150 mm – 6 "
08-102-150



LANGE 1:2

220 mm – 8 ¾ "
08-103-220



CITTLE 1:2

160 mm – 6 ¼ "
08-104-160



FIMIN 1:2

170 mm – 6 ¾ "
08-105-170



CITTLE 1:2

150 mm – 6 "



1:1

08-106-001



1:1

08-106-002



1:1

08-106-003

NEOA
INDUSTRY

Nasenhäkchen Nasal hooks

Crochets nasales
Ganchitos nasales
Uncini nasali

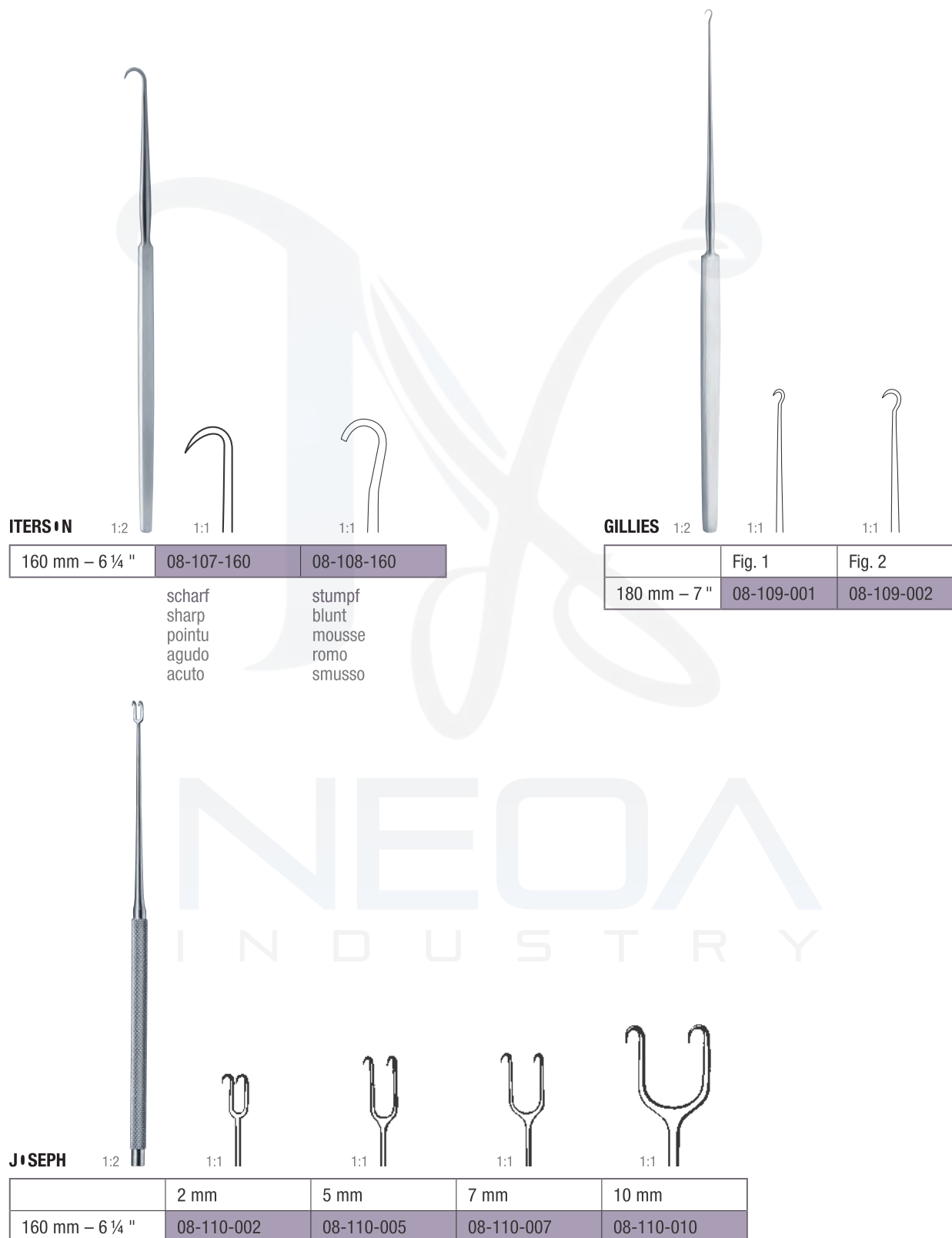

ITERS•N 1:2 1:1 1:1

160 mm – 6 ¼ "	08-107-160	08-108-160
	scharf sharp pointu agudo acuto	stumpf blunt mousse romo smusso

GILLIES 1:2 1:1 1:1

	Fig. 1	Fig. 2
180 mm – 7 "	08-109-001	08-109-002

J•SEPH 1:2 1:1 1:1 1:1 1:1

	2 mm	5 mm	7 mm	10 mm
160 mm – 6 ¼ "	08-110-002	08-110-005	08-110-007	08-110-010

Nasenhäkchen
Nasal hooks

Crochets nasales
Ganchitos nasales
Uncini nasali



C•TTLE-NEIVERT 1:2

200 mm – 8" 08-111-200



F•M•N 1:2

160 mm – 6 ¼" 08-112-160



C•TTLE 1:2

150 mm – 6" 08-112-140 08-113-010 08-113-020



1:1



1:1



1:1



NEIVERT 1:2

160 mm – 6 ¼" 08-114-160

Nasen- und trachealhäkchen
Nose and trachea hooks

Ecarteurs nasales et tracheales
Separadores traqueales y nasales
Uncini tracheali e nasali

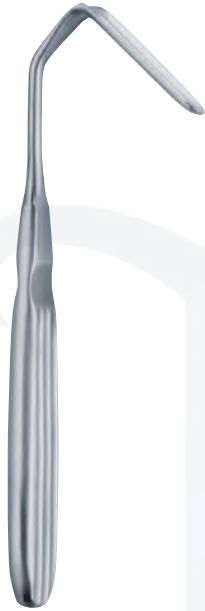

AUFRICHT

1:2

160 mm – 6 ¼ " 160 mm – 6 ¼ "

08-115-160 08-116-160

mit Kaltlichtaufsatz
with F.O. light carrier
avec support lumière froide
con guía de luz fría
con supporto per luce fredda



KILNER

1:2

100 mm – 4 " 08-117-100



C•NVERSE

1:2

120 mm – 4 ¾ " 08-118-120



C•TTLE

1:2

1:2

150 mm – 6 " 08-119-150 08-120-150



JACKS•N

1:2

150 mm – 6 " 08-121-150

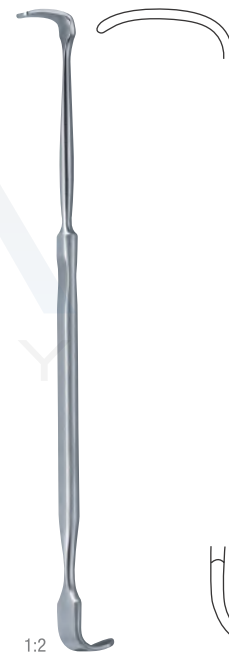

LUKENS

1:2

170 mm – 6 ⅔ " 08-122-170

stumpf
blunt
mousse
romo
smusso

Trachealhäkchen

Trachea hooks

Ecarteurs tracheales

Separadores traqueales

Uncini tracheali



JACKS • N

1:2

170 mm – 6²/₃ "

08-123-170



JACKS • N

1:2

180 mm – 7 "

08-124-180

08-125-180

stumpf
blunt
mousse
romo
smusso

scharf
sharp
pointu
agudo
acuto

NEOA
INDUSTRY

Wundhaken
Retractors

Ecarteurs
Separadores
Divaricatori



RISE 1:2
130 mm – 5" 08-126-130



LUER 1:2
110 mm – 4 ¼" 08-127-110



SCHLENKER 1:2
210 mm – 8 ¼" 08-128-210

NEOA
INDUSTRY

Wundhaken Retractors

*Ecarteurs
Separadores
Divaricatori*



EMMET

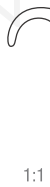

	Fig. 1	Fig. 2	Fig. 3	Fig. 4	Fig. 5
220 mm – 8 3/4 "	08-129-001	08-129-002	08-129-003	08-129-004	08-129-005



160 mm – 6 1/4 "	08-130-001	08-130-002	08-130-003	08-130-004
------------------	------------	------------	------------	------------

scharf
sharp
pointu
agudo
acuto



160 mm – 6 1/4 "	08-131-001	08-131-002	08-131-003	08-131-004
------------------	------------	------------	------------	------------

stumpf
blunt
mousse
romo
smusso

Wundhaken Retractors

*Ecarteurs
Separadores
Divaricatori*



160 mm – 6 ¼ "	08-132-002	08-132-003	08-132-004
----------------	------------	------------	------------

flexibel, scharf
flexible, sharp
flexible, pointu
flexible, agudo
flessibile, acuto



160 mm – 6 ¼ "	08-133-002	08-133-003	08-133-004
----------------	------------	------------	------------

flexibel, stumpf
flexible, blunt
flexible, mousse
flexible, romo
flessibile, smusso

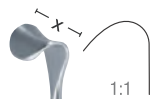

DESMARRES



	x = 8 mm	x = 10 mm	x = 12 mm
160 mm – 6 ¼ "	08-134-080	08-134-100	08-134-120

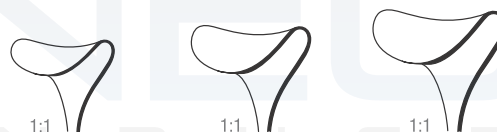

	x = 14 mm	x = 16 mm	x = 18 mm
160 mm – 6 ¼ "	08-134-140	08-134-160	08-134-180

1:2



1:2

KNAPP (RILLET)

160 mm – 6 ¼ "	08-135-130	08-136-130	08-137-130
----------------	------------	------------	------------

flexibel, scharf	2 Zähne	3 Zähne	4 Zähne
flexible, sharp	2 Teeth	3 Teeth	4 Teeth
flexible, pointu	2 Dents	3 Dents	4 Dents
flexible, agudo	2 Dientes	3 Dientes	4 Dientes
flessibile, acuto	2 Denti	3 Denti	4 Denti

Wundhaken Retractors

*Ecarteurs
Separadores
Divaricatori*



1:2

MINI-LANGENBECK



	10 mm x 6 mm	17 mm x 5 mm	20 mm x 6 mm	22 mm x 8 mm
160 mm – 6 ¼ "	08-138-100	08-138-170	08-138-200	08-138-220



1:2

KLICHER



220 mm – 8 ¾ "	08-139-010	08-139-020	08-139-030	08-139-040	08-139-060	08-139-080
----------------	------------	------------	------------	------------	------------	------------

scharf
sharp
pointu
agudo
acuto



220 mm – 8 ¾ "	08-140-010	08-140-020	08-140-030	08-140-040	08-140-060	08-140-080
----------------	------------	------------	------------	------------	------------	------------

stumpf
blunt
mousse
romo
smusso



220 mm – 8 ¾ "	08-141-010	08-141-020	08-141-030	08-141-040	08-141-060	08-141-080
----------------	------------	------------	------------	------------	------------	------------

halbscharf
semi-sharp
semi-pointu
semi-agudo
semi-acuto

Wundhaken Retractors

Ecarteurs *Separadores* *Divaricatori*

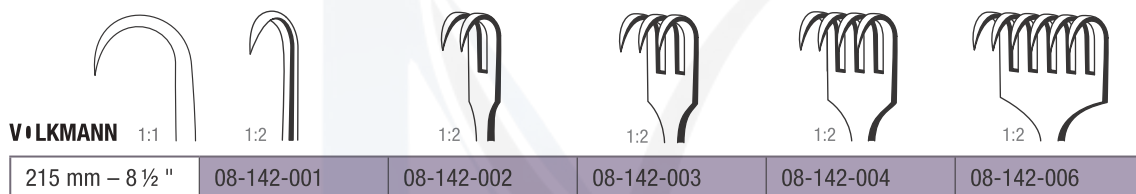

scharf
sharp
pointu
agudo
acuto

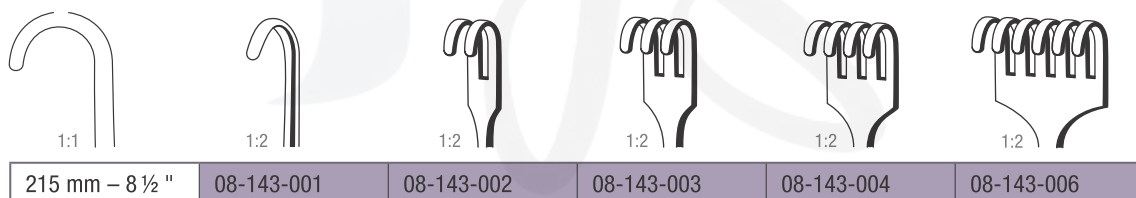

stumpf
blunt
mousse
romo
smusso

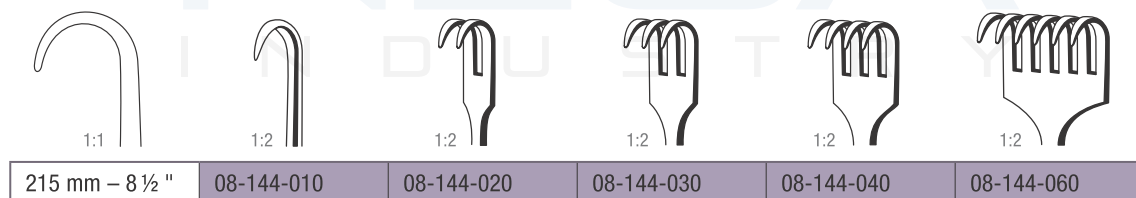

halbscharf
semi-sharp
semi-pointu
semi-agudo
semi-acuto



1:2

Wundhaken
Retractors

Ecarteurs
Separadores
Divaricatori



1:2

VOLKMANN

215 mm – 8 ½ "	08-145-010	08-146-010
----------------	------------	------------

scharf
sharp
pointu
agudo
acuto

stumpf
blunt
mousse
romo
smusso

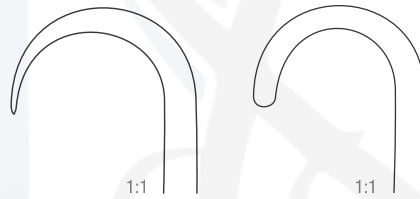

1:2

SENN-MUELLER

160 mm – 6 ¼ "	08-147-160	08-148-160
----------------	------------	------------

scharf
sharp
pointu
agudo
acuto

stumpf
blunt
mousse
romo
smusso

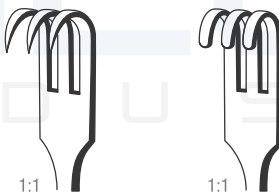

1:2

KILNER

155 mm – 6 "	08-149-155
--------------	------------



1:1

Wundhaken Retractors

*Ecarteurs
Separadores
Divaricatori*



1:2
**STRANDELL-
STILLE**

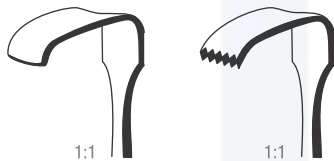

	20 mm x 6 mm	20 mm x 6 mm
190 mm – 7 ½ "	08-150-010	08-150-020

gezahnt
saw edge
dentelé
dentado
dentato

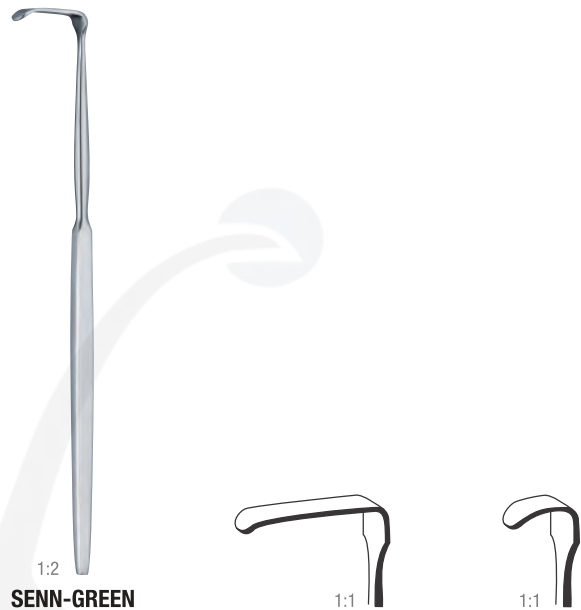

1:2
SENN-GREEN

	20 mm x 6 mm	10 mm x 6 mm
150 mm – 6 "	08-151-200	08-151-100



**RAGNELL-
DAVIS**

140 mm – 5 ½ "
08-152-140

NEODA
INDUSTRY



COTTLE

150 mm – 6 "
08-153-140



CRILE

110 mm – 4 ¼ "
08-154-110

Wundhaken Retractors

*Ecarteurs
Separadores
Divaricatori*



MIDDELD • RPF

14 mm x 17 mm	20 mm x 22 mm	26 mm x 30 mm
215 mm – 8 ½ "	220 mm – 8 ¾ "	235 mm – 9 ¼ "
08-155-001	08-155-002	08-155-003



MEYERDING



	18 mm x 7 mm	16 mm x 5 mm
180 mm – 7 "	08-157-010	08-157-020



	7 mm x 4 mm	7 mm x 4 mm
180 mm – 7 "	08-157-030	08-157-040

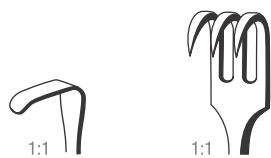

	10 mm x 3 mm	10 mm x 4 mm
180 mm – 7 "	08-157-050	08-157-060

1:2

Wundhaken
Retractors

Ecarteurs
Separadores
Divaricatori



K•ERTE 1:2

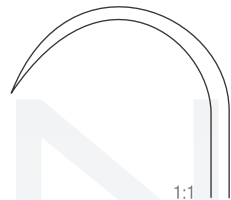

1:1

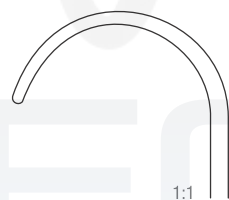

1:1

	26 mm x 40 mm	26 mm x 40 mm
235 mm – 9 ¼ "	08-158-235	08-159-235

scharf
sharp
pointu
agudo
acuto

stumpf
blunt
mousse
romo
smusso



GREEN 1:2

215 mm – 8 ½ "	08-159-220
----------------	------------

Wundhaken Retractors

*Ecarteurs
Separadores
Divaricatori*



1:2

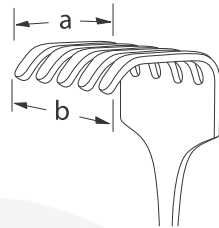

ISRAEL

	a = 40 mm – b = 40 mm	a = 45 mm – b = 50 mm
250 mm – 9 ¾ "	08-160-400	08-160-500

4 Zähne
4 Teeth
4 Dents
4 Dientes
4 Denti

5 Zähne
5 Teeth
5 Dents
5 Dientes
5 Denti

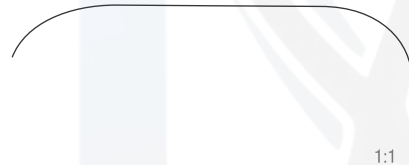

1:1



1:1

	a = 50 mm – b = 60 mm	a = 70 mm – b = 70 mm
250 mm – 9 ¾ "	08-160-600	08-160-700

6 Zähne
6 Teeth
6 Dents
6 Dientes
6 Denti

6 Zähne
6 Teeth
6 Dents
6 Dientes
6 Denti



1:2

LANGENBECK



1:1



1:1



1:1

	Fig. 1	Fig. 2	Fig. 3
	30 mm x 11 mm	30 mm x 14 mm	30 mm x 16 mm
220 mm – 8 ¾ "	08-161-010	08-161-020	08-161-030



1:1



1:1

	Fig. 4	Fig. 5
	40 mm x 11 mm	50 mm x 11 mm
220 mm – 8 ¾ "	08-161-040	08-161-050

Wundhaken Retractors

*Ecarteurs
Separadores
Divaricatori*



LANGENBECK



	Fig. 1	Fig. 2	Fig. 3
	30 mm x 11 mm	30 mm x 14 mm	30 mm x 16 mm
210 mm – 8 ¼ "	08-162-001	08-162-002	08-162-003

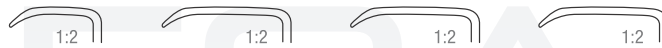

	Fig. 4	Fig. 5
	40 mm x 11 mm	50 mm x 11 mm
210 mm – 8 ¼ "	08-162-004	08-162-005

1:2



K•CHER-LANGENBECK (•BWEGESER)



	25 mm x 6 mm	35 mm x 8 mm	35 mm x 11 mm	35 mm x 15 mm
215 mm – 8 ½ "	08-163-010	08-163-020	08-163-030	08-163-040

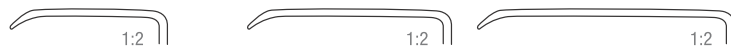

	42 mm x 11 mm	55 mm x 11 mm	70 mm x 14 mm
215 mm – 8 ½ "	08-163-050	08-163-060	08-163-070



	80 mm x 12 mm	80 mm x 16 mm
215 mm – 8 ½ "	08-163-080	08-163-090

1:2

Wundhaken Retractors

*Ecarteurs
Separadores
Divaricatori*



CUSHING

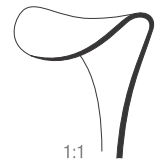

	x = 8 mm	x = 10 mm	x = 12 mm	x = 14 mm	x = 16 mm	x = 18 mm
200 mm – 8 "	08-164-080	08-164-100	08-164-120	08-164-140	08-164-160	08-164-180
240 mm – 9 ½ "	08-165-080	08-165-100	08-165-120	08-165-140	08-165-160	08-165-180



• BWEGESER

	40 mm x 11 mm	55 mm x 11 mm
220 mm – 8 ¾ "	08-166-400	08-166-550

	80 mm x 16 mm
220 mm – 8 ¾ "	08-166-800

Wundhaken
Retractors

Ecarteurs
Separadores
Divaricatori



1:2

• BWEGESER

1:1

1:1

	42 mm x 10 mm	70 mm x 11 mm
220 mm – 8 ¾ "	08-167-220	08-168-220

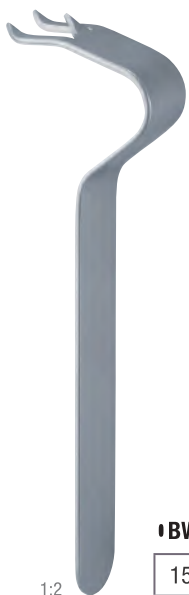

1:2

• BWEGESER

155 mm – 6 "	08-169-160
--------------	------------



1:2

• BWEGESER

	x = 8 mm	x = 10 mm
160 mm – 6 ¼ "	08-170-080	08-170-100

biegsam
malleable
malléable
maleable
flessibile

Wundhaken
Retractors

Ecarteurs
Separadores
Divaricatori



•LLIER

1:2

1:2

	a = 36 mm – b = 30 mm	a = 36 mm – b = 60 mm
225 mm – 8 ¾ "	08-171-003	08-171-004

Wundhaken
Retractors

*Ecarteurs
Separadores
Divaricatori*



KICHER 1:2

	25 mm x 8 mm	55 mm x 11 mm	40 mm x 12 mm	75 mm x 12 mm	85 mm x 12 mm	100 mm x 12 mm
210 mm – 8 ¼ "	08-172-080	08-172-550	08-172-400	08-172-750	08-172-850	08-172-100



1:2

LANGENBECK

	55 mm x 20 mm	60 mm x 20 mm
210 mm – 8 ¼ "	08-173-220	08-173-210



1:2

LANGENBECK

	85 mm x 15 mm
210 mm – 8 ¼ "	08-174-210

Griff vertikal zum Blatt
Handle vertical to the blade
Poignée verticale à la lame
Mango vertical a la hoja
Manico verticale verso la lama

Wundhaken Retractors

*Ecarteurs
Separadores
Divaricatori*

SAUERBRUCH

	45 mm x 15 mm	60 mm x 23 mm
225 mm – 8 ¾ "	08-175-450	08-175-600

	75 mm x 20 mm
220 mm – 8 ¾ "	08-175-750

LAHEY

190 mm – 7 ½ "
28 mm x 6 mm
08-176-190

K•CHER

	19 mm x 12 mm	21 mm x 14 mm
190 mm – 7 ½ "	08-177-190	08-177-210

K•CHER

	40 mm x 10 mm	40 mm x 15 mm	40 mm x 20 mm
220 cm – 8 ¾ "	08-178-100	08-178-150	08-178-200

1:2

Wundhaken
Retractors

*Ecarteurs
Separadores
Divaricatori*



1:2

K•CHER

1:1

1:1

	40 mm x 18 mm	60 mm x 20 mm
230 mm – 9"	08-179-180	08-179-200

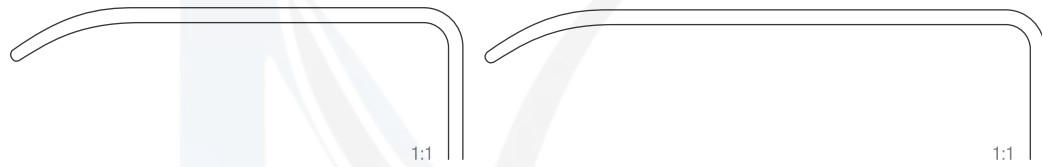

1:1

1:1

	60 mm x 25 mm	75 mm x 30 mm
230 mm – 9"	08-179-250	08-179-300

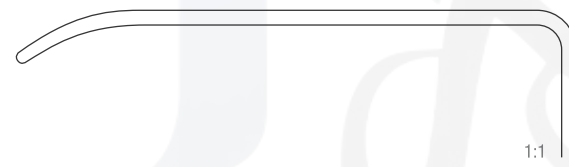

1:1

	75 mm x 40 mm
230 mm – 9"	08-179-400



1:2

NEOA
INDUSTRY

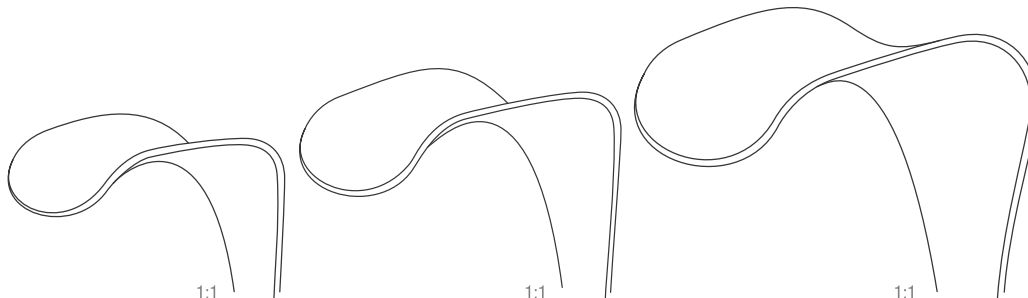

1:1

1:1

1:1

RICHARDS • N

	25 mm x 20 mm	36 mm x 28 mm	44 mm x 38 mm
240 mm – 9½"	08-180-025	08-180-030	08-180-038

Wundhaken
Retractors

Ecarteurs
Separadores
Divaricatori



RICHARDS • N-EASTMAN

	Fig. 1	Fig. 2
	280 mm – 11 "	260 mm – 10¼ "
	49 mm x 38 mm	36 mm x 28 mm
	71 mm x 43 mm	28 mm x 20 mm
08-181-010	x	
08-181-020		x
08-181-000	x	x



RICHARDS • N

240 mm – 9 ½ "
52 mm x 22 mm
08-182-240



KELLY

260 mm – 10 ¼ "
65 mm x 50 mm
08-183-260

Wundhaken
Retractors

*Ecarteurs
Separadores
Divaricatori*



1:2

H•ESEL

260 mm – 10 ¼ "

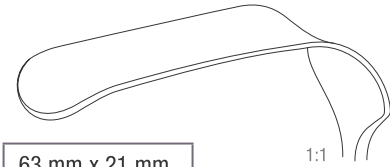

1:1

63 mm x 21 mm

08-184-010

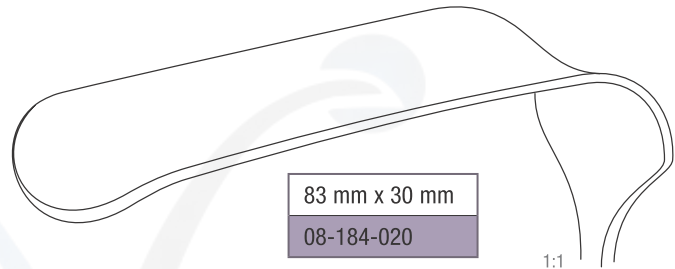

1:1

83 mm x 30 mm

08-184-020

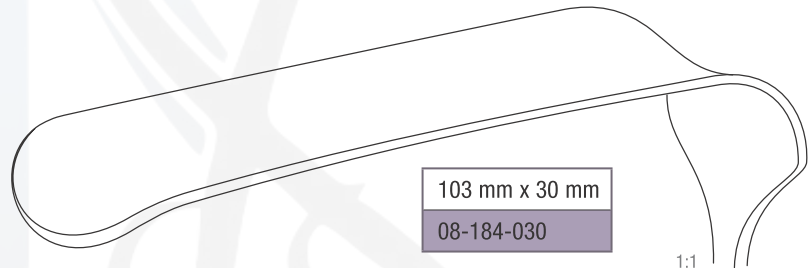

1:1

103 mm x 30 mm

08-184-030



1:1

120 mm x 30 mm

08-184-040

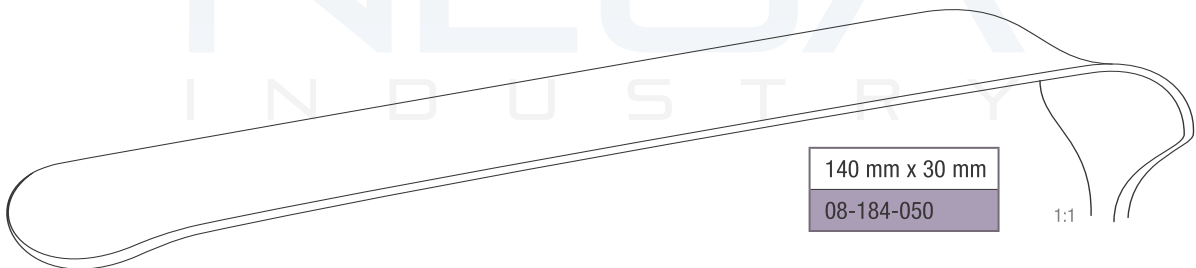

1:1

140 mm x 30 mm

08-184-050

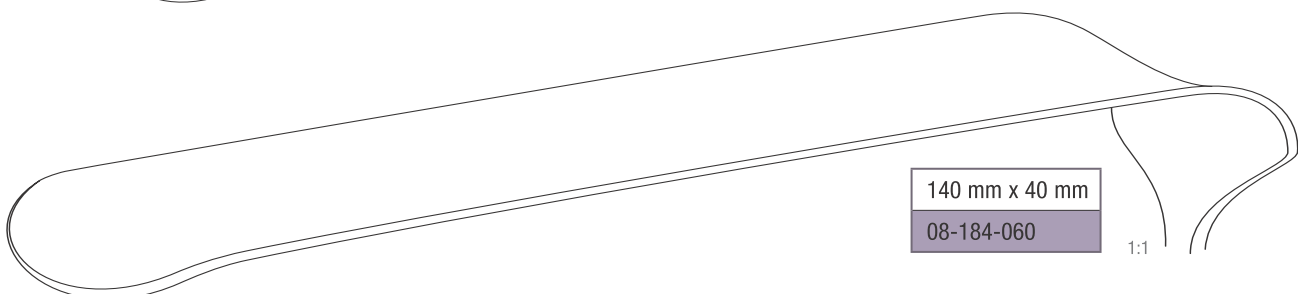

1:1

140 mm x 40 mm

08-184-060

Wundhaken Retractors

*Ecarteurs
Separadores
Divaricatori*



MEYERDING

200 mm – 8 "	220 mm – 8 ¾ "
50 mm x 16 mm	75 mm x 25 mm
08-185-010	08-185-020

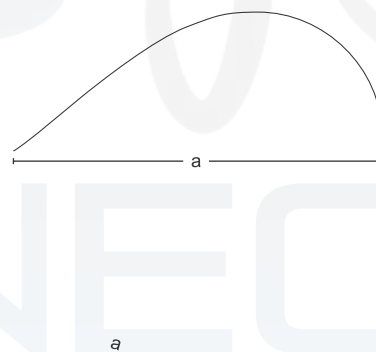
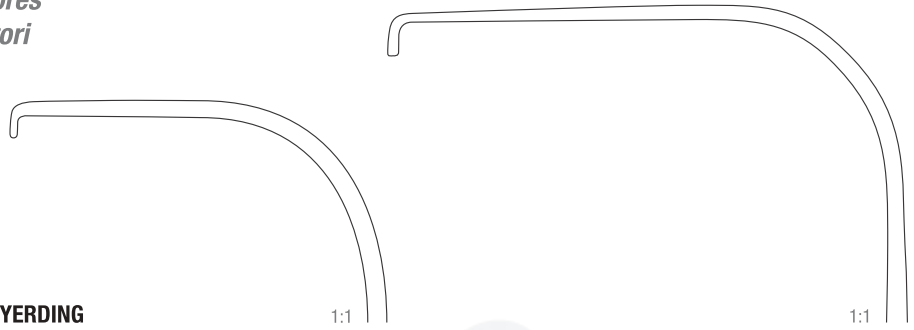

240 mm – 9 ½ "
90 mm x 50 mm
08-185-030

FRITSCH

240 mm – 9 ½ "	a = 32 mm – b = 40 mm	08-186-000
240 mm – 9 ½ "	a = 45 mm – b = 40 mm	08-186-001
240 mm – 9 ½ "	a = 45 mm – b = 50 mm	08-186-002
240 mm – 9 ½ "	a = 45 mm – b = 60 mm	08-186-003
240 mm – 9 ½ "	a = 45 mm – b = 75 mm	08-186-004
240 mm – 9 ½ "	a = 65 mm – b = 85 mm	08-186-005

Wundhaken Retractors

*Ecarteurs
Separadores
Divaricatori*



1:3

SIM•N

1:1

	115 mm x 22 mm	115 mm x 27 mm
280 cm – 11 "	08-187-220	08-187-270



1:3

HARRINGT•N

1:1

	127 mm x 40 mm	127 mm x 62 mm
320 mm – 12 ½ "	08-188-001	08-188-002

Wundhaken
Retractors

Ecarteurs
Separadores
Divaricatori

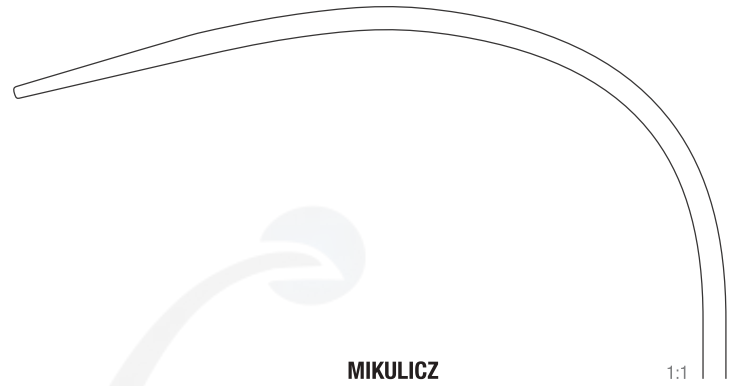

MIKULICZ

	95 mm x 35 mm
260 mm – 10 ¼ "	08-189-095



120 mm x 50 mm
08-189-120



150 mm x 50 mm	180 mm x 50 mm
08-189-150	08-189-180

Wundhaken
Retractors

Ecarteurs
Separadores
Divaricatori



MIKULICZ

1:2

260 mm – 10 ¼ "	90 mm x 50 mm	08-190-090
-----------------	---------------	------------



1:2

DAVIDS • N

	a = 75 mm – b = 50 mm	a = 75 mm – b = 90 mm
160 mm – 6 ¼ "	08-191-500	08-191-900

Wundhaken
Retractors

Ecarteurs
Separadores
Divaricatori



KELLY

1:3

	160 mm x 38 mm	190 mm x 38 mm	160 mm x 57 mm	190 mm x 57 mm
270 mm – 10 ¾ "	08-192-380	08-192-381	08-192-570	08-192-571

Wundhaken
Retractors

Ecarteurs
Separadores
Divaricatori



1:2



ZENKER

250 mm – 9 ¾ "	260 mm – 10 ¼ "	275 mm – 10 ¾ "	290 mm – 11 ½ "
35 mm x 8 mm	60 mm x 12 mm	75 mm x 12 mm	120 mm x 12 mm
08-193-350	08-193-600	08-193-750	08-193-100

Wundhaken
Retractors

Ecarteurs
Separadores
Divaricatori



COILEY

1:2

1:2

1:2

250 mm – 9 ¾ "	250 mm – 9 ¾ "	270 mm – 10 ½ "
08-194-010	08-194-020	08-194-030

rechts
right
droite
derecha
destra

rechts, gerieft
right, serrated
droite, strié
derecha, estriada
destra, zigrinato

links
left
gauche
izquierda
sinistra

Wundhaken
Retractors

Ecarteurs
Separadores
Divaricatori



1:2

MIDDELD • RPF

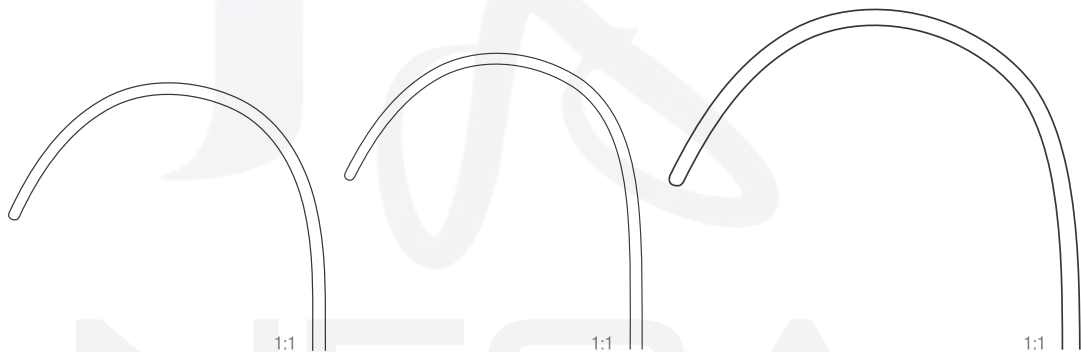

1:1

1:1

1:1

	45 mm x 45 mm	45 mm x 50 mm	55 mm x 70 mm
255 mm – 10"	08-195-010	08-195-020	08-195-030

INDUSTRY

Wundhaken
Retractors

Ecarteurs
Separadores
Divaricatori

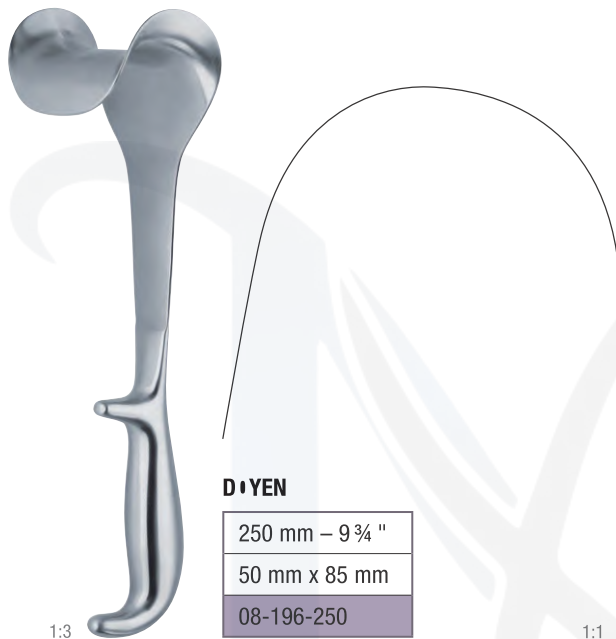

D•YEN

250 mm – 9 ¾ "
50 mm x 85 mm
08-196-250



TUFFIER

230 mm – 9 "
64 mm x 60 mm
08-197-230

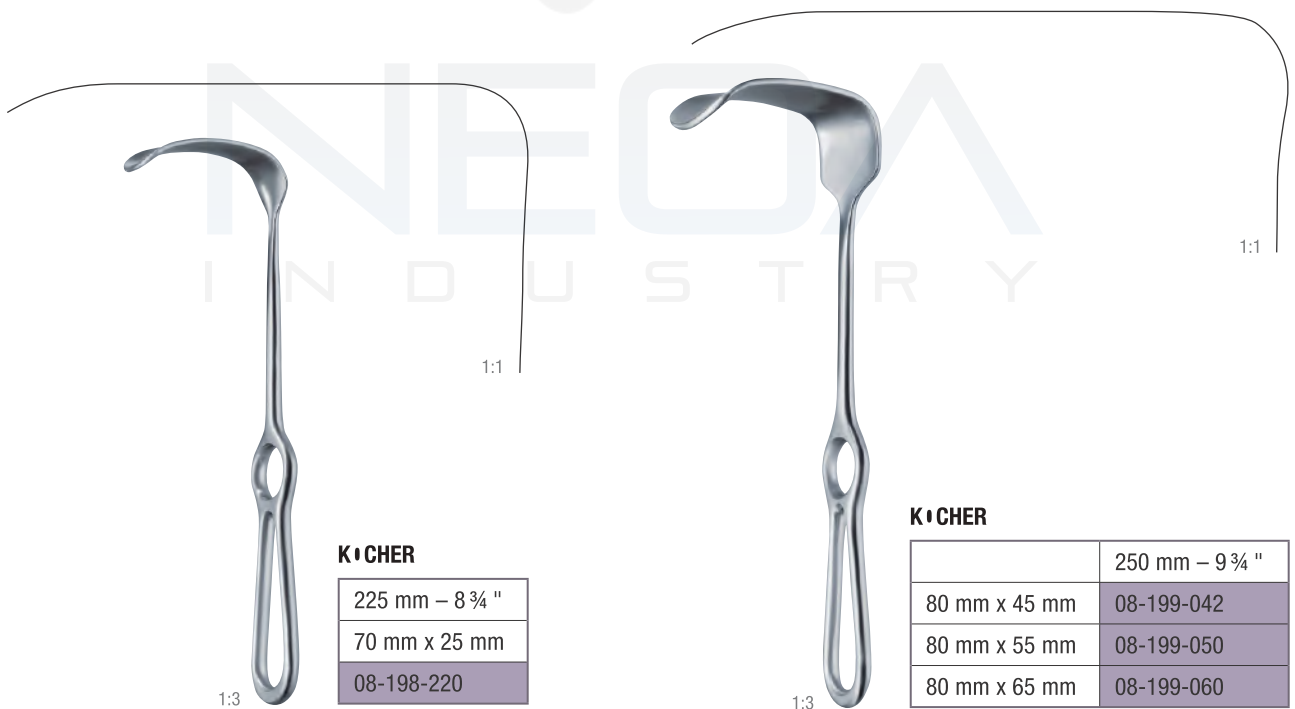

K•CHER

225 mm – 8 ¾ "
70 mm x 25 mm
08-198-220

K•CHER

	250 mm – 9 ¾ "
80 mm x 45 mm	08-199-042
80 mm x 55 mm	08-199-050
80 mm x 65 mm	08-199-060

Wundhaken
Retractors

Ecarteurs
Separadores
Divaricatori

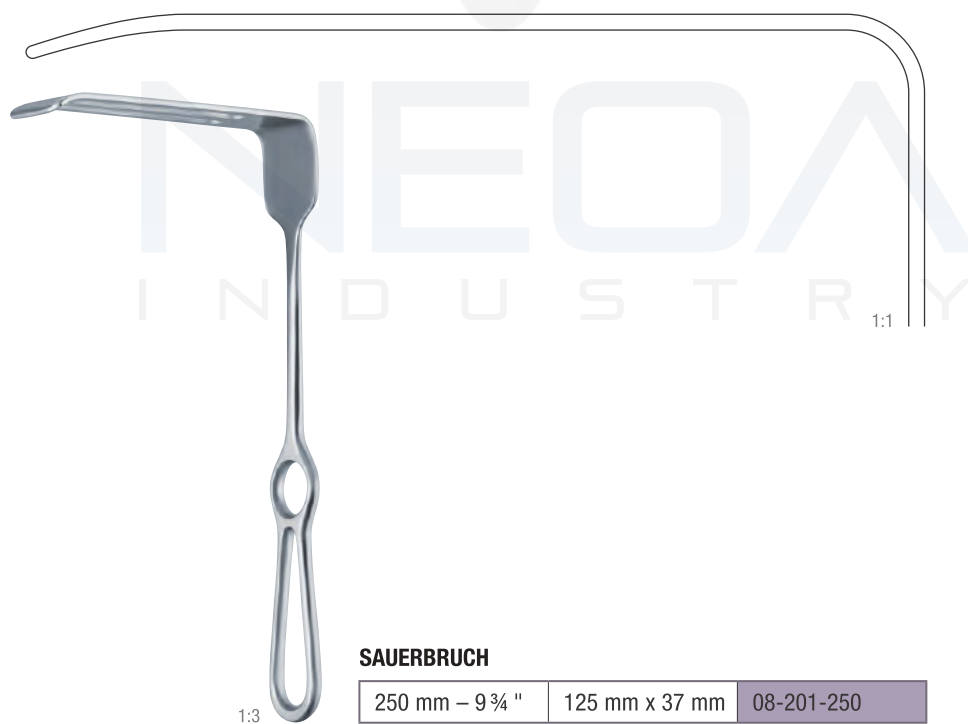

Wundhaken
Retractors

Ecarteurs
Separadores
Divaricatori

HEANEY

	45 mm x 25 mm	73 mm x 28 mm
270 mm – 10 3/4 "	08-202-450	08-202-730

1:1

1:1

1:1

82 mm x 28 mm
08-202-820

1:2

C•RYLL•S

	82 mm x 22 mm
240 mm – 9 1/2 "	08-203-220

1:1

1:1

108 mm x 43 mm
08-203-430

1:1

115 mm x 65 mm
08-203-650

1:2

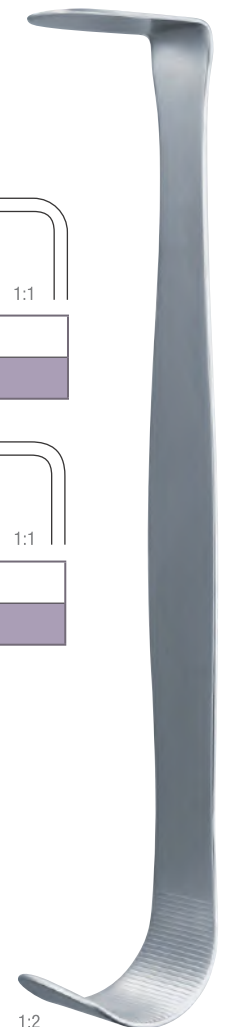

Wundhaken
Retractors

Ecarteurs
Separadores
Divaricatori



1:2

BRUNNER

250 mm – 9 3/4 "

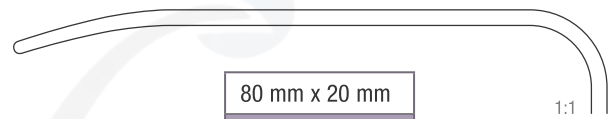

80 mm x 20 mm

08-204-080

1:1



100 mm x 20 mm

08-204-100

1:1



120 mm x 25 mm

08-204-120

1:1

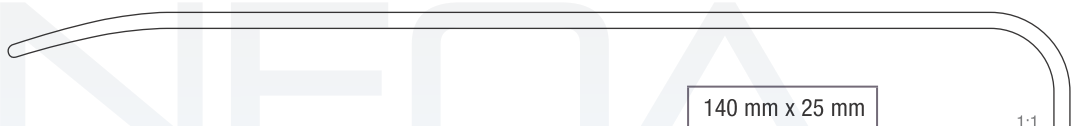

140 mm x 25 mm

08-204-140

1:1

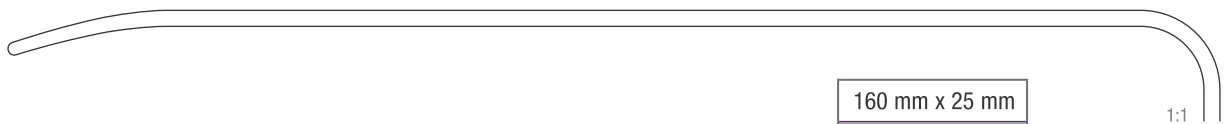

160 mm x 25 mm

08-204-160

1:1

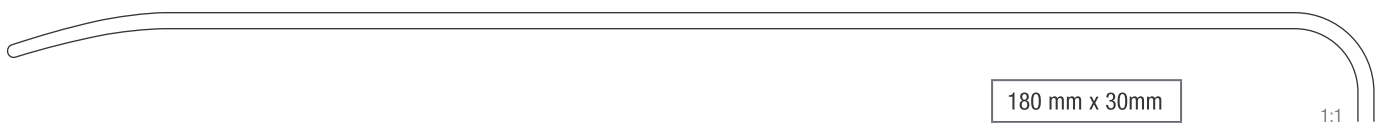

180 mm x 30mm

08-204-180

1:1

Wundhaken
Retractors

Ecarteurs
Separadores
Divaricatori



BRUNNER

1:2

240 mm – 9 ½ "	142 mm x 25 mm	08-205-240
----------------	----------------	------------

Wundhaken Retractors

*Ecarteurs
Separadores
Divaricatori*

x

GIL-VERNET

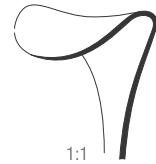

	x = 8 mm	x = 11 mm	x = 15 mm	x = 17 mm	x = 20 mm	x = 23 mm
240 mm – 9 ½ "	08-206-080	08-206-110	08-206-150	08-206-170	08-206-200	08-206-230

biegsam
malleable
malléable
maleable
malleabile

1:2



ST. MARKS

1:3

1:3

1:3

290 mm – 11 ½ "	325 mm – 12 ¾ "	330 mm – 13 "
130 mm x 60 mm	180 mm x 60 mm	180 mm x 60 mm
08-207-020	08-207-010	08-207-030

Wundhaken
Retractors

*Ecarteurs
Separadores
Divaricatori*

CUSHING

200 mm – 8 "

08-208-200

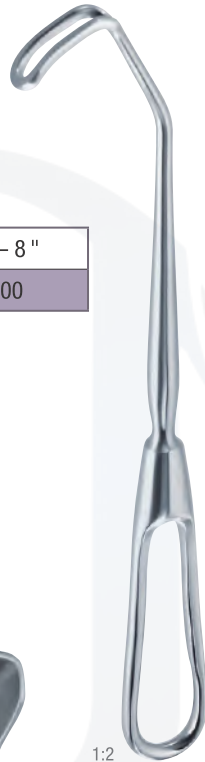

K•ERTE

280 mm – 11 "

120 mm x 47 mm

08-209-280

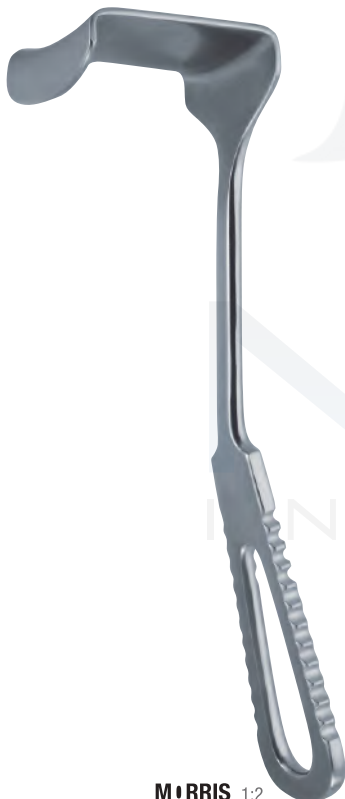

M•RRIS 1:2

210 mm – 8 ¼ "

50 mm x 55 mm

08-210-500



M•RRIS

1:2

	38 mm x 51 mm	50 mm x 55 mm	64 mm x 51 mm
245 mm – 9 ¾ "	08-211-380	08-211-510	08-211-640

Wundhaken
Retractors

Ecarteurs
Separadores
Divaricatori



DEAVER

	x = 25 mm	x = 38 mm	x = 50 mm
315 mm – 12½"	08-212-250	08-212-380	08-212-500

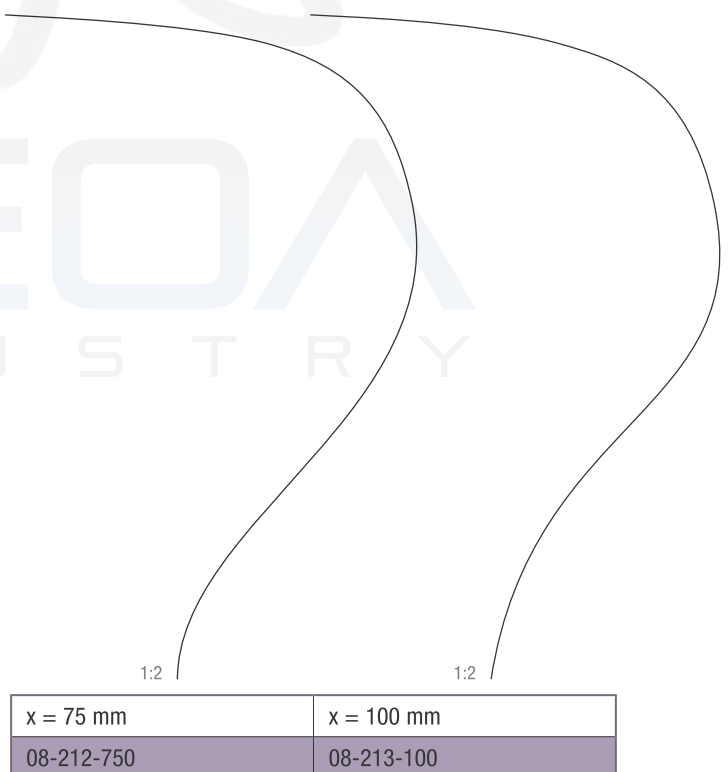

x = 75 mm	x = 100 mm
08-212-750	08-213-100

Wundhaken
Retractors

Ecarteurs
Separadores
Divaricatori



DEAVER 1:2

1:2

1:2

180 mm – 7 "	215 mm – 8 ½ "	230 mm – 9 "
x = 19 mm	x = 22 mm	x = 25 mm
08-215-001	08-215-002	08-215-003

Wundhaken
Retractors

Ecarteurs
Separadores
Divaricatori



DEAVER

1:2

1:2

1:2

300 mm – 12 "	330 mm – 13 "	360 mm – 14 ¼ "
x = 25 mm	x = 25 mm	x = 25 mm
08-215-004	08-215-005	08-215-006

Wundhaken
Retractors

Ecarteurs
Separadores
Divaricatori



DEAVER 1:2

1:2

1:2

300 mm – 12"	300 mm – 12"	300 mm – 12"
x = 38 mm	x = 50 mm	x = 75 mm
08-215-007	08-215-008	08-215-009

Wundhaken Retractors

*Ecarteurs
Separadores
Divaricatori*



R·UX

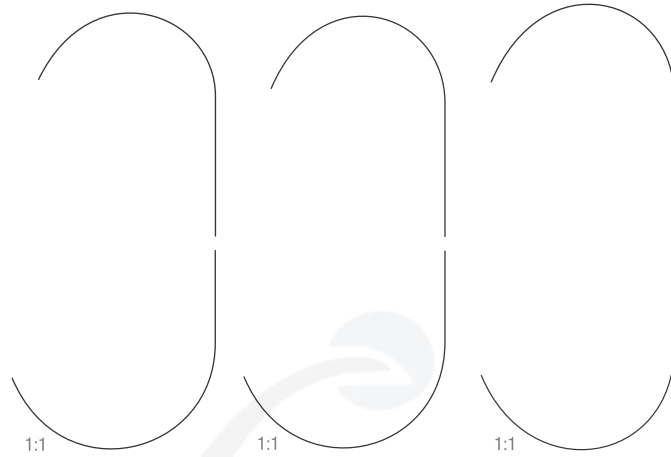
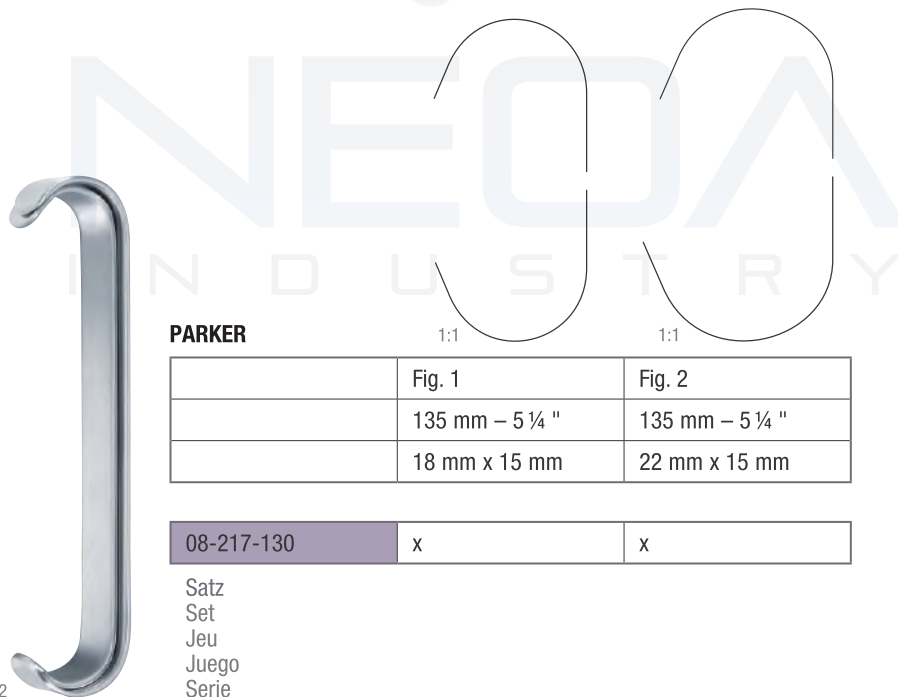

	Fig. 1	Fig. 2	Fig. 3
	140 mm – 5 ½ "	150 mm – 6 "	170 mm – 6 ¾ "
	24 mm x 20 mm	29 mm x 26 mm	33 mm x 29 mm
	30 mm x 28 mm	36 mm x 36 mm	38 mm x 43 mm
	08-216-001	08-216-002	08-216-003

08-216-000	x	x	x
------------	---	---	---

Satz
Set
Jeu
Juego
Serie



PARKER

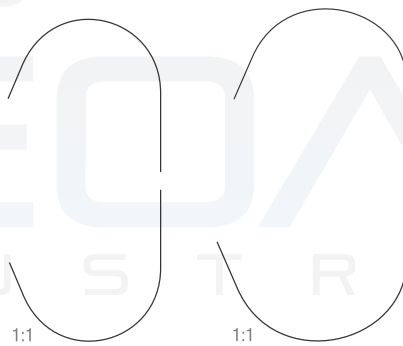

	Fig. 1	Fig. 2
	135 mm – 5 ¼ "	135 mm – 5 ¼ "
	18 mm x 15 mm	22 mm x 15 mm

08-217-130	x	x
------------	---	---

Satz
Set
Jeu
Juego
Serie

Wundhaken
Retractors

Ecarteurs
Separadores
Divaricatori



1:2

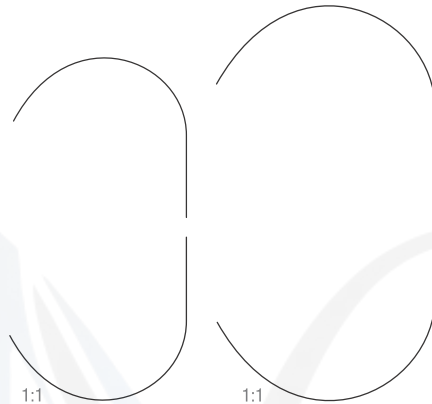

PARKER

180 mm – 7"	Fig. 1	Fig. 2
	26 mm x 25 mm	29 mm x 25 mm
	27 mm x 25 mm	27 mm x 25 mm

08-217-180	x	x
------------	---	---

Satz
Set
Jeu
Juego
Serie



1:2

MINI-R UX

145 mm – 5 ¾"
8 mm x 6 mm
08-218-150



1:2

BABY-R UX

130 mm – 5"
17 mm x 16 mm
18 mm x 22 mm
08-219-130

Wundhaken Retractors

*Ecarteurs
Separadores
Divaricatori*



MAY-COLLIN

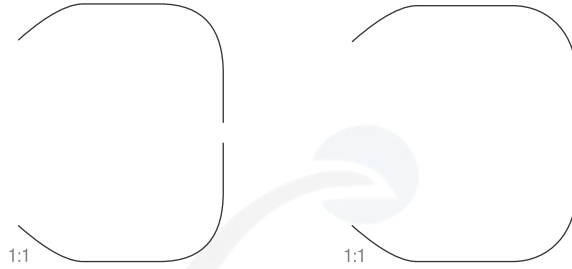

150 mm – 6 "	Fig. 1	Fig. 2
	25 mm x 18 mm	28 mm x 19 mm
	28 mm x 18 mm	32 mm x 19 mm

08-220-150	x	x
------------	---	---

Satz
Set
Jeu
Juego
Serie



PARKER-LANGENBECK (US ARMY)



210 mm – 8 ¼ "	Fig. 1	Fig. 2
	21 mm x 24 mm	25 mm x 24 mm
	40 mm x 15 mm	45 mm x 15 mm

08-221-000	x	x
------------	---	---

Satz
Set
Jeu
Juego
Serie

Wundhaken
Retractors

Ecarteurs
Separadores
Divaricatori



1:2



1:1

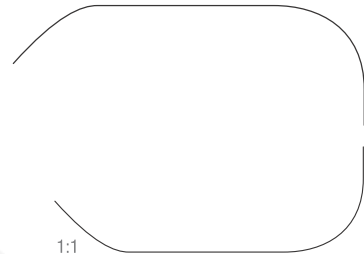

1:1

MATHIEU

200 mm – 8"	Fig. 1	Fig. 2
	42 mm x 13 mm	47 mm x 13 mm
	42 mm x 26 mm	46 mm x 26 mm
	08-222-010	08-222-020

08-222-200	x	x
------------	---	---

Satz
Set
Jeu
Juego
Serie

INDUSTRY

Wundhaken
Retractors

*Ecarteurs
Separadores
Divaricatori*



1:2

FARABEUF

1:1

1:1

120 mm – 4 ¾ "	Fig. 1	Fig. 2
	26 mm x 10 mm	30 mm x 10 mm
	30 mm x 12 mm	34 mm x 12 mm

08-223-000	x	x
------------	---	---

Satz
Set
Jeu
Juego
Serie



1:2

FARABEUF

1:1

1:1

150 mm – 6 "	Fig. 1	Fig. 2
	23 mm x 16 mm	27 mm x 16 mm
	26 mm x 16 mm	30 mm x 16 mm

08-224-000	x	x
------------	---	---

Satz
Set
Jeu
Juego
Serie

Wundhaken Retractors

Ecarteurs Separadores Divaricatori



ALM

70 mm – 2 ¾ "	08-225-070	08-226-070	08-227-070
100 mm – 4 "	08-225-100	08-226-100	08-227-100

scharf
sharp
pointu
agudo
acuto

halbscharf
semi sharp
semi pointu
semi agudo
semi acuto

stumpf
blunt
mousse
romo
smusso



BISE

1:2

70 mm – 2 ¾ "	08-232-070
---------------	------------



HOLTZHEIMER 1:2

100 mm – 4 "	08-228-100	08-229-100
--------------	------------	------------

scharf
sharp
pointu
agudo
acuto

stumpf
blunt
mousse
romo
smusso



JANSEN 1:2

100 mm – 4 "	08-230-100	08-231-100
--------------	------------	------------

scharf
sharp
pointu
agudo
acuto

stumpf
blunt
mousse
romo
smusso

Wundsperrer
Self-retaining retractors

Ecarteurs autostatiques
Separadores autoestáticos
Divaricatori autostatici



CLWARD-CANTUR 1:2

140 mm – 5 ½ "	08-233-140	08-234-140
3 x 4 scharf sharp pointu agudo acuto		3 x 4 stumpf blunt mousse romo smusso

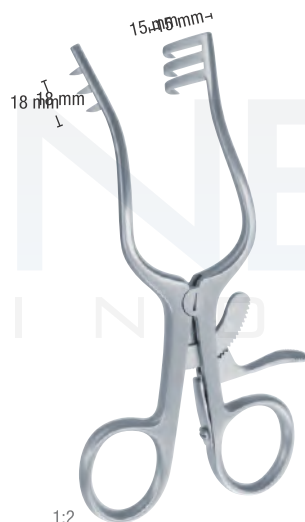

WEITLANER-WULLSTEIN 1:2

130 mm – 5 "	08-235-130	08-236-130
3 x 3 scharf sharp pointu agudo acuto		3 x 3 stumpf blunt mousse romo smusso



MILLIGAN 1:2

130 mm – 5 "	08-237-130
3 x 3 stumpf blunt mousse romo smusso	

Wundsperrer
Self-retaining retractors
Ecarteurs autostatiques
Separadores autoestáticos
Divaricatori autostatici



1:2



1:2

BELLUCCI

110 mm – 4 ¼ "	08-238-110	08-239-110
----------------	------------	------------

1 x 2
links, stumpf
left, blunt
gauche, mousse
izquierda, romo
sinistra, smusso

1 x 2
rechts, stumpf
right, blunt
droit, mousse
derecha, romo
destra, smusso



1:2

MOLLIS

150 mm – 6 "	08-240-150
--------------	------------

4 x 4
scharf
sharp
pointu
agudo
acuto

Wundsperrer
Self-retaining retractors

Ecarteurs autostatiques
Separadores autoestáticos
Divaricatori autostatici

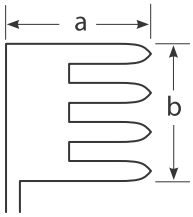

WEITLANER-L • KTITE

105 mm – 4 ¼ "	a = 17 mm – b = 13 mm	08-250-105	08-251-105	08-252-105			
130 mm – 5 "	a = 17 mm – b = 17 mm				08-241-130	08-242-130	08-243-130
165 mm – 6 ½ "	a = 17 mm – b = 17 mm				08-244-165	08-245-165	08-246-165
200 mm – 8 "	a = 20 mm – b = 19 mm				08-247-200	08-248-200	08-249-200
260 mm – 10 ¼ "	a = 26 mm – b = 21 mm				08-253-260	08-254-260	08-255-260
		2 x 3 scharf sharp pointu agudo acuto	2 x 3 halbscharf semi sharp semi pointu semi agudo semi acuto	2 x 3 stumpf blunt mousse romo smusso	3 x 4 scharf sharp pointu agudo acuto	3 x 4 halbscharf semi sharp semi pointu semi agudo semi acuto	3 x 4 stumpf blunt mousse romo smusso

Wundsperrer
Self-retaining retractors

Ecarteurs autostatiques
Separadores autoestáticos
Divaricatori autostatici



1:2

PLESTER

130 mm – 5"	08-256-130	08-257-130
-------------	------------	------------

2 x 2
stumpf
blunt
mousse
romo
smusso

2 x 2
scharf
sharp
pointu
agudo
acuto



PLESTER

1:2

1:2

110 mm – 4¼"	08-258-110	08-259-110
--------------	------------	------------

2 x 1
links, stumpf
left, blunt
gauche, mousse
izquierda, romo
sinistra, smusso

2 x 1
rechts, stumpf
right, blunt
droit, mousse
derecha, romo
destra, smusso

Wundsperrer
Self-retaining retractors
Ecarteurs autostatiques
Separadores autoestáticos
Divaricatori autostatici



1:2

**NORFOLK
AND NORWICH**

220 mm – 8 ¾ "	08-260-220
----------------	------------

4 x 5
stumpf
blunt
mousse
romo
smusso



1:2

TRAVERS

215 mm – 8 ½ "	08-261-210
----------------	------------

4 x 5
stumpf
blunt
mousse
romo
smusso



1:2

ANDERS-N-ADS-N

195 mm – 7 ¾ "	08-262-190	08-263-200
----------------	------------	------------

4 x 4
scharf
sharp
pointu
agudo
acuto

4 x 4
stumpf
blunt
mousse
romo
smusso

Wundsperrer
Self-retaining retractors

Ecarteurs autostatiques
Separadores autoestáticos
Divaricatori autostatici



ADS•N (C•NE)

130 mm – 5 "	a = 17 mm – b = 19 mm	08-264-130	08-265-130
160 mm – 6 ¼ "	a = 17 mm – b = 19 mm	08-264-160	08-265-160
200 mm – 8 "	a = 20 mm – b = 20 mm	08-264-200	08-265-200
260 mm – 10 ¼ "	a = 26 mm – b = 21 mm	08-264-260	08-265-260

3 x 4
scharf
sharp
pointu
agudo
acuto

3 x 4
stumpf
blunt
mousse
romo
smusso

BECKMANN-EAT•N

320 mm – 12 ½ "
08-266-320

7 x 7
scharf
sharp
pointu
agudo
acuto

Wundsperrer
Self-retaining retractors

Ecarteurs autostatiques
Separadores autoestáticos
Divaricatori autostatici

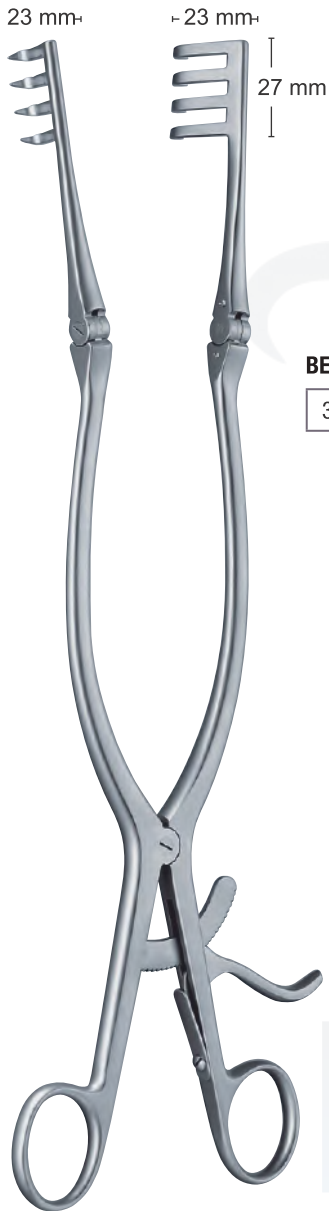

BECKMANN

310 mm – 12 ¼ "	08-267-310	08-268-310	08-269-310
4 x 4	4 x 4	4 x 4	4 x 4
scharf	halbscharf	stumpf	stumpf
sharp	semi sharp	blunt	mousse
pointu	semi pointu	romoso	romoso
agudo	semi agudo	smusso	smusso
acuto	semi acuto		

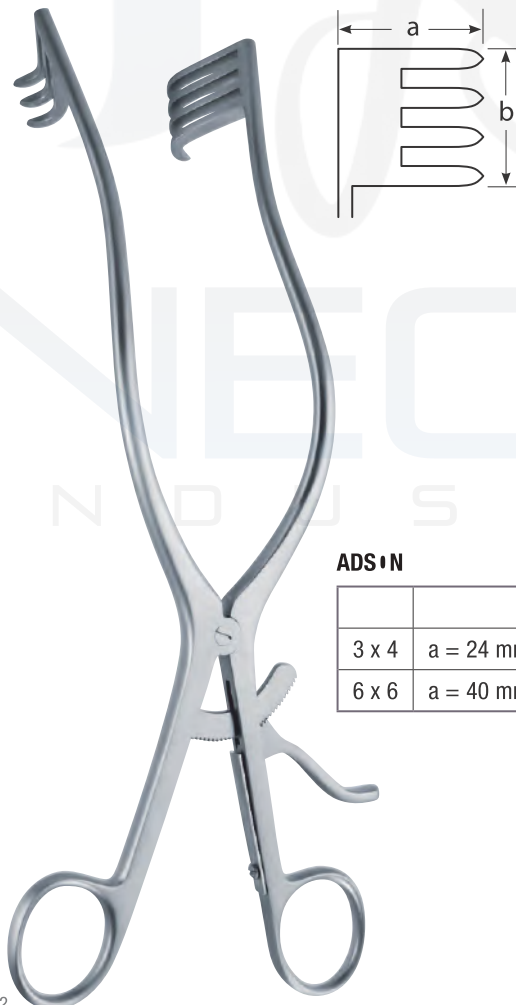

ADS+N

		265 mm – 10 ½ "	265 mm – 10 ½ "
3 x 4	a = 24 mm – b = 24 mm	08-270-260	08-271-260
6 x 6	a = 40 mm – b = 40 mm	08-270-270	08-271-270
		scharf	stumpf
		sharp	blunt
		pointu	mousse
		agudo	romoso
		acuto	smusso

1:2

Wundsperrer
Self-retaining retractors

Ecarteurs autostatiques
Separadores autoestáticos
Divaricatori autostatici



1:2

BECKMANN-ADS • N

310 mm – 12 ¼ "

08-272-000

stumpf
blunt
mousse
romo
smusso



1:1

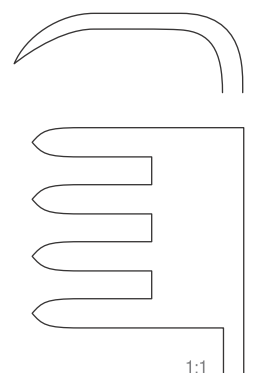

1:1

08-272-010

scharf
sharp
pointu
agudo
acuto

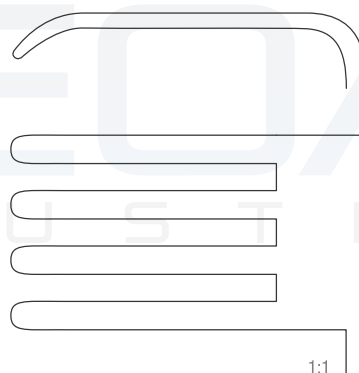

1:1

08-272-020

stumpf, mit tiefen Blättern
blunt, with deep blades
mousse, avec lames profondes
romo, con palas profundas
smusso, con valve profunde

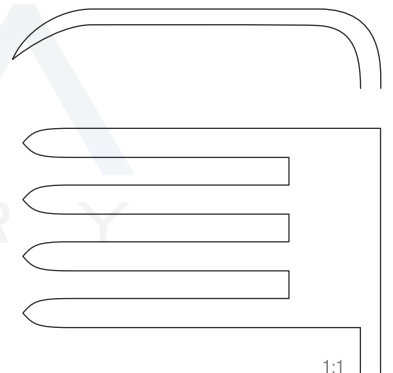

1:1

08-272-030

scharf, mit tiefen Blättern
sharp, with deep blades
pointu, avec lames profondes
agudo, con palas profundas
acuto, con valve profunde

Wundsperrer
Self-retaining retractors

Ecarteurs autostatiques
Separadores autoestáticos
Divaricatori autostatici



RIGBY 1:2

180 mm – 7"	08-273-180
-------------	------------



GELPI-L•KTITE

1:2

90 mm – 3 ½ "	08-274-090	
110 mm – 4 ¼ "	08-274-110	
140 mm – 5 ½ "	08-275-140	
160 mm – 6 ⅔ "	08-275-160	
180 mm – 7 "	08-275-180	08-276-180



1:2

MARKHAM-
MEYERDING

180 mm – 7"	08-277-180	08-278-180
-------------	------------	------------

rechts
right
droit
derecha
destra

links
left
gauche
izquierda
sinistra

Wundsperrer
Self-retaining retractors

Ecarteurs autostatiques
Separadores autoestáticos
Divaricatori autostatici



1:2

HENLEY

165 mm – 6 ½ "	08-279-000	08-280-000
----------------	------------	------------

3 x 4
scharf
sharp
pointu
agudo
acuto

3 x 4
stumpf
blunt
mousse
romo
smusso

komplett mit 3 Mittelvalven
complete with 3 center blades
complet avec 3 valves centrales
completa con 3 valvas centrales
completo con 3 valve centrali



19 mm x 16 mm	25 mm x 16 mm	32 mm x 16 mm
08-280-190	08-280-250	08-280-320

Mittelvalven
Center blades
Valves centrales
Valvas centrales
Valve centrali

**bauchdeckenhalter
Abdominal retractors**

*Ecarteurs abdominaux
Separadores abdominales
Divaricatori addominali*

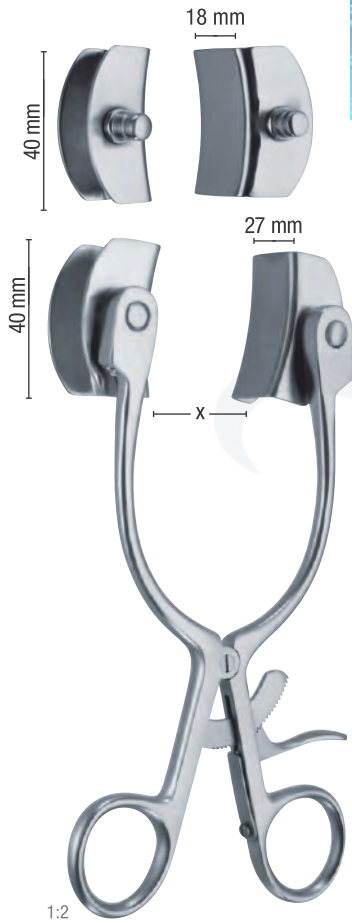

BABY-C•LLIN

180 mm – 7"		
x = 80 mm		
08-281-000	40 mm x 18 mm	40 mm x 27 mm

komplett mit 2 Paar Valven
complete with 2 pairs of blades
complet avec 2 paires de valves
completo con 2 pares de valvas
completo con 2 paia di valve



C•LLIN 1:2

220 mm – 8 3/4"	x = 100 mm	08-282-220
-----------------	------------	------------



C•LLIN

225 mm – 8 3/4"		
x = 100 mm		
08-283-000	a = 38 mm – b = 55 mm	a = 38 mm – b = 55 mm
08-284-000	a = 38 mm – b = 80 mm	a = 50 mm – b = 75 mm

komplett mit
complete with
complet avec
completo con
completo con

Seitenvalven
Lateral blades
Valves latérales
Valvas laterales
Valve laterali

Mittelvalve
Center blade
Valve centrale
Valva central
Valva centrale

bauchdeckenhalter
Abdominal retractors

Ecarteurs abdominaux
Separadores abdominales
Divaricatori addominali



COLLIN 1:2

260 mm – 10 ½ "		
x = 160 mm		
08-285-000	60 mm x 80 mm	60 mm x 75 mm

komplett mit
complete with
complet avec
completo con
completo con

Seitenvalven
Lateral blades
Valves latérales
Valvas laterales
Valve laterali

Mittelvalve
Center blade
Valve centrale
Valva central
Valva centrale

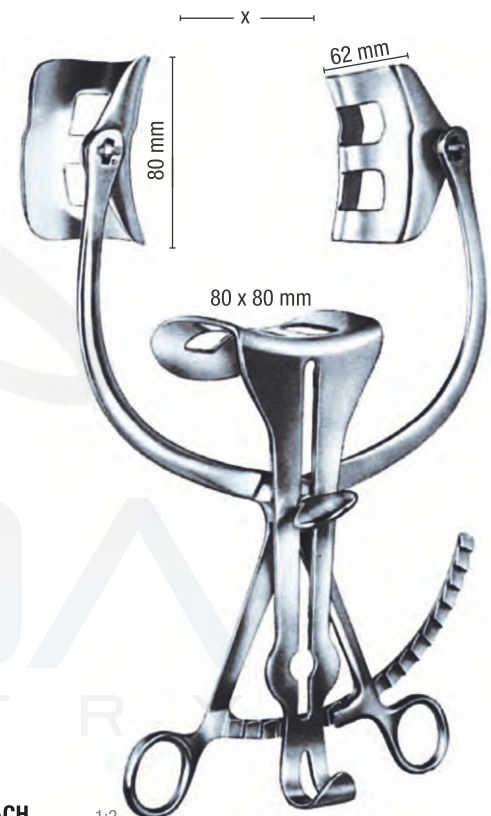

H•LZBACH 1:2

260 mm – 10 ¼ "		
x = 100 mm		
08-286-000	62 mm x 80 mm	80 mm x 80 mm

komplett mit
complete with
complet avec
completo con
completo con

Seitenvalven
Lateral blades
Valves latérales
Valvas laterales
Valve laterali

Mittelvalve
Center blade
Valve centrale
Valva central
Valva centrale

bauchdeckenhalter
Abdominal retractors

Ecarteurs abdominaux
Separadores abdominales
Divaricatori addominali



G•SSET

1:2

125 mm – 5"	x = 100 mm	08-287-000
-------------	------------	------------

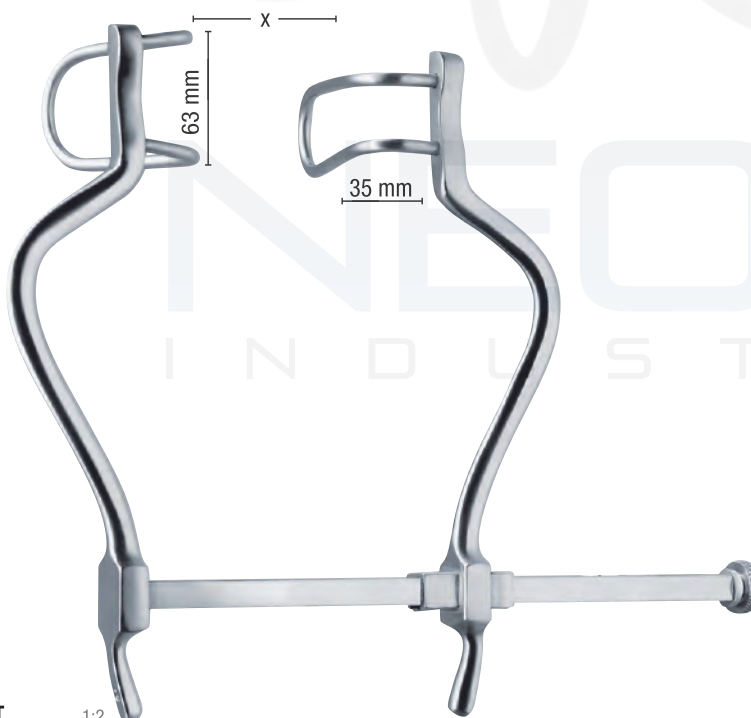

G•SSET

1:2

185 mm – 7 ¼"	x = 140 mm	08-288-000
---------------	------------	------------

bauchdeckenhalter
Abdominal retractors

Ecarteurs abdominaux
Separadores abdominales
Divaricatori addominali



G•SSET

1:3

x = 160 mm		
08-289-160	35 mm x 63 mm	65 mm x 70 mm

komplett mit
complete with
complet avec
completo con
completo con

Seitenvalven
Lateral blades
Valves latérales
Valvas laterales
Valve laterali

Mittelvalve
Center blade
Valve centrale
Valva central
Valva centrale



BALF•UR

1:3

x = 200 mm		
08-290-000	35 mm x 100 mm	70 mm x 100 mm

komplett mit
complete with
complet avec
completo con
completo con

Seitenvalven
Lateral blades
Valves latérales
Valvas laterales
Valve laterali

Mittelvalve
Center blade
Valve centrale
Valva central
Valva centrale

bauchdeckenhalter
Abdominal retractors

Ecarteurs abdominaux
Separadores abdominales
Divaricatori addominali



BALF•UR

x = 180 mm		
08-291-000	35 mm x 70 mm	45 mm x 80 mm

komplett mit
complete with
complet avec
completo con
completo con

Seitenvalven
Lateral blades
Valves latérales
Valvas laterales
Valve laterali

Mittelvalve
Center blade
Valve centrale
Valva central
Valva centrale

x = 250 mm		
08-292-250	35 mm x 100 mm	70 mm x 85 mm

komplett mit
complete with
complet avec
completo con
completo con

Seitenvalven
Lateral blades
Valves latérales
Valvas laterales
Valve laterali

Mittelvalve
Center blade
Valve centrale
Valva central
Valva centrale

45 mm x 80 mm	08-293-450
70 mm x 85 mm	08-293-700
80 mm x 90 mm	08-293-800

Mittelvalven, allein
Center blades, only
Valves centrales, seul
Valvas centrales, sola
Valve centrali, solo



BALF•UR-BABY

x = 90 mm		
08-294-000	27 mm x 27 mm	20 mm x 24 mm

komplett mit
complete with
complet avec
completo con
completo con

Seitenvalven
Lateral blades
Valves latérales
Valvas laterales
Valve laterali

Mittelvalve
Center blade
Valve centrale
Valva central
Valva centrale

bauchdeckenhalter
Abdominal retractors

Ecarteurs abdominaux
Separadores abdominales
Divaricatori addominali



1:3

RICARD

08-295-280	60 mm x 80 mm	55 mm x 70 mm
------------	---------------	---------------

komplett mit
complete with
complet avec
completo con
completo con

Seitenvalven
Lateral blades
Valves latérales
Valvas laterales
Valve laterali

Mittelvalve
Center blade
Valve centrale
Valva central
Valva centrale

08-295-300	70 mm x 85 mm	80 mm x 90 mm
------------	---------------	---------------

komplett mit
complete with
complet avec
completo con
completo con

Seitenvalven
Lateral blades
Valves latérales
Valvas laterales
Valve laterali

Mittelvalve
Center blade
Valve centrale
Valva central
Valva centrale



1:3

**SULLIVAN-
CINNO**

08-296-000	45 mm x 90 mm	70 mm x 100 mm
------------	---------------	----------------

komplett mit
complete with
complet avec
completo con
completo con

Seitenvalven
Lateral blades
Valves latérales
Valvas laterales
Valve laterali

Mittelvalve
Center blade
Valve centrale
Valva central
Valva centrale

**bauchdeckenhalter
Abdominal retractors**

*Ecarteurs abdominaux
Separadores abdominales
Divaricatori addominali*

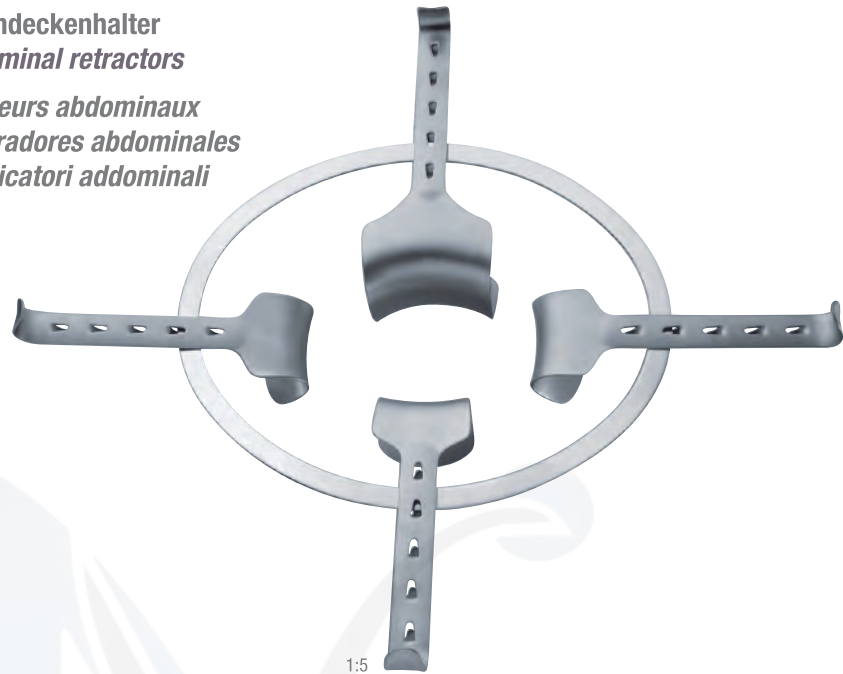

KIRSCHNER, VAL

240 mm x 300 mm	50 mm x 65 mm	80 mm x 90 mm	50 mm x 98 mm	35 mm x 105 mm
08-297-300	08-298-050	08-299-080	08-299-098	08-299-105
1 Rahmen 1 Frame 1 Cadre 1 Cuadro 1 Quadro	3 Valven 3 Blades 3 Valves 3 Valvas 3 Valve	1 Valve 1 Blade 1 Valve 1 Valva 1 Valva	1 Valve 1 Blade 1 Valve 1 Valva 1 Valva	1 Valve 1 Blade 1 Valve 1 Valva 1 Valva

08-300-000	x	x	x	x	x
------------	---	---	---	---	---

Satz
Set
Jeu
Juego
Serie

KIRSCHNER

240 mm x 240 mm	40 mm x 55 mm	50 mm x 65 mm
08-301-000	08-298-040	08-298-050
1 Rahmen, fest 1 Frame, rigid 1 Cadre, rigide 1 Cuadro, rígido 1 Quadro, rigido	2 Valven 2 Blades 2 Valves 2 Valvas 2 Valve	2 Valven 2 Blades 2 Valves 2 Valvas 2 Valve

08-302-000	x	x	x
------------	---	---	---

Satz
Set
Jeu
Juego
Serie

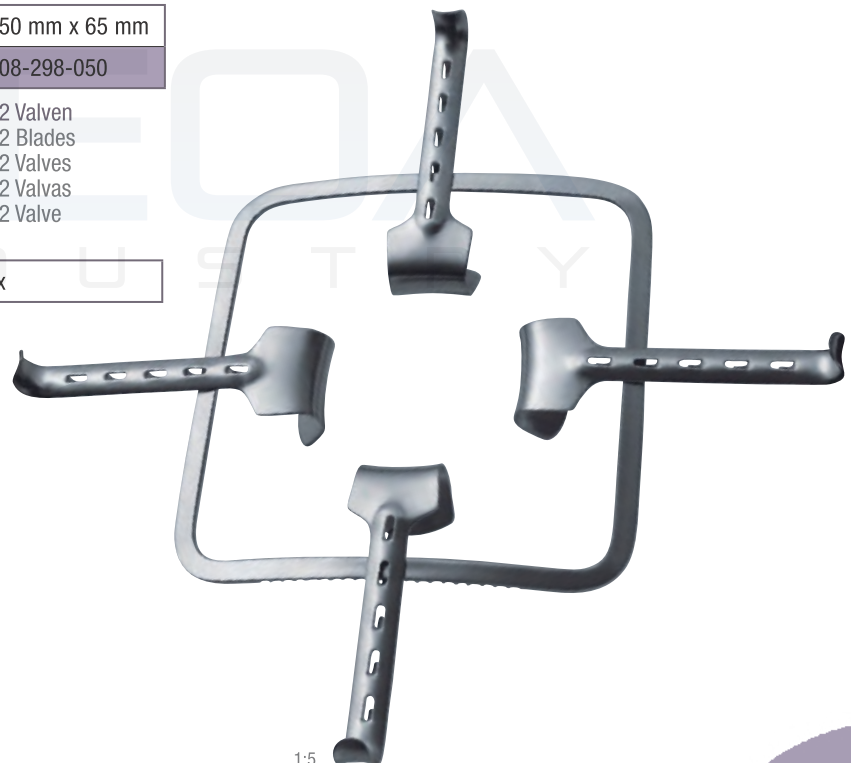

bauchdeckenhalter
Abdominal retractors

Ecarteurs abdominaux
Separadores abdominales
Divaricatori addominali



Rahmen zusammenlegbar
Frame foldable
Cadre pliant
Cuadro plegable
Quadro piegabile

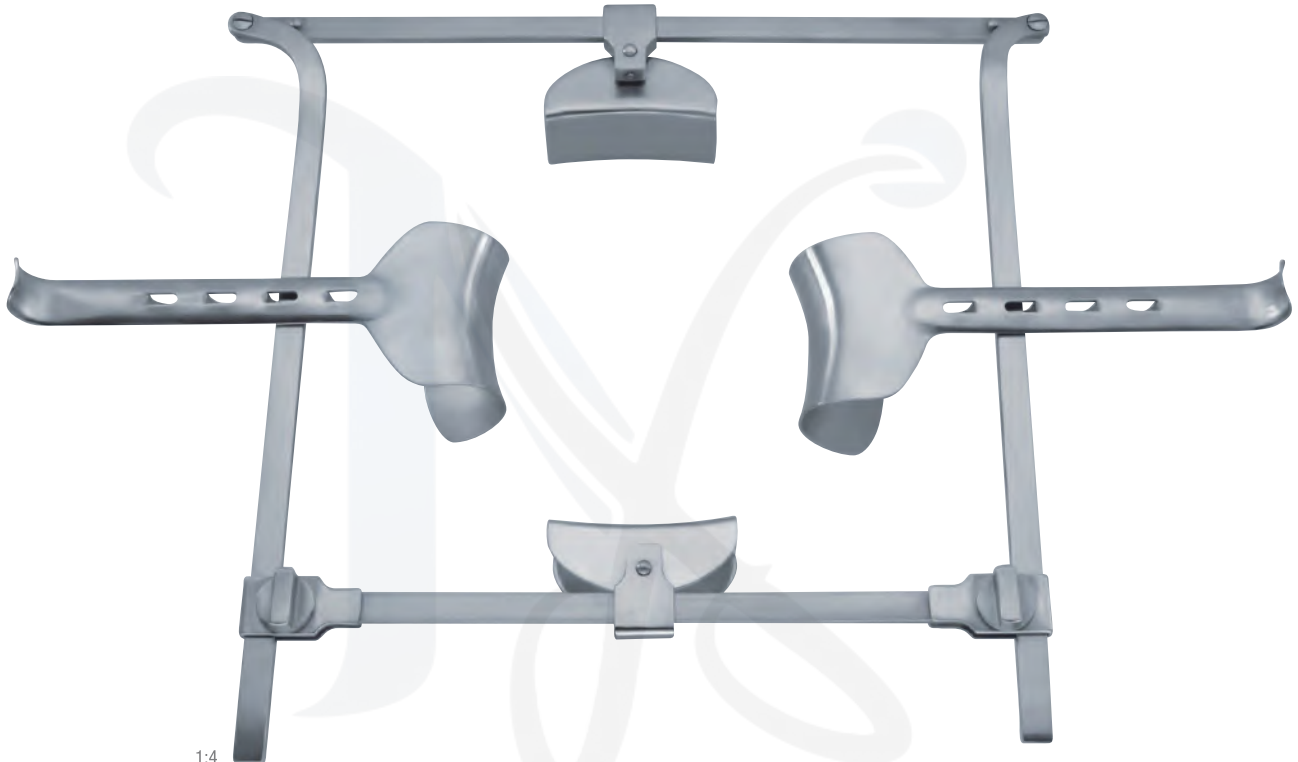

1:4
FRANZ

300 mm x 300 mm	40 mm x 60 mm	45 mm x 80 mm	50 mm x 65 mm	60 mm x 85 mm
08-303-300	08-305-380	08-305-450	08-298-050	08-306-600
1 Rahmen, zusammenlegbar	2 Valven	2 Valven	2 Valven	2 Valven
1 Frame, foldable	2 Blades	2 Blades	2 Blades	2 Blades
1 Cadre pliant	2 Valves	2 Valves	2 Valves	2 Valves
1 Cuadro plegable	2 Valvas	2 Valvas	2 Valvas	2 Valvas
1 Quadro piegabile	2 Valve	2 Valve	2 Valve	2 Valve

08-303-000	x	x		x	
08-307-000	x	x	x	x	x

Satz
Set
Jeu
Juego
Serie



1:4

bauchdeckenhalter
Abdominal retractors

Ecarteurs abdominaux
Separadores abdominales
Divaricatori addominali



Valven für Kirschner- und Franz-Rahmen
Blades for Kirschner- and Franz-frames
Valves pour cadres Kirschner et Franz
Valvas para los cuadros de Kirschner y Franz
Valve per i quadri di Kirschner e Franz



40 mm x 60 mm	45 mm x 80 mm	40 mm x 55 mm	50 mm x 65 mm
08-305-380	08-305-450	08-298-040	08-298-050



60 mm x 85 mm	80 mm x 90 mm	50 mm x 98 mm	35 mm x 105 mm
08-306-600	08-299-080	08-299-098	08-299-105

bauchspatel
Abdominal spatula
Spatula abdominales
Espátulas abdominales
Spatole addominali



RIBB • N

	19 mm	25 mm	30 mm	40 mm	50 mm
330 mm – 13 "	08-308-190	08-308-250	08-308-320	08-308-400	08-308-500

biegsam
 malleable
 malléable
 maleable
 flessibile

RIBB • N

	6 mm	9 mm	12 mm	17 mm	20 mm
200 mm – 8 "	08-309-060	08-309-090	08-309-120	08-309-170	08-309-200

weich
 soft
 souple
 flexible
 morbido

	25 mm
250 mm – 9 ¾ "	08-309-250

weich
 soft
 souple
 flexible
 morbido

	6,5 mm	9,5 mm	13 mm	16 mm	19 mm	25 mm
200 mm – 8 "	08-310-060	08-310-090	08-310-130	08-310-160	08-310-190	08-310-250

biegsam, sehr weich
 malleable, very soft
 malléable, très souple
 maleable, muy flexible
 flessibile, molto morbido



bauchspatel
Abdominal spatula
Spatula abdominales
Espátulas abdominales
Spatole addominali



HABERER

200 mm – 8 "	280 mm – 11 "	300 mm – 12 "
17 mm x 25 mm	25 mm x 30 mm	37 mm x 45 mm
08-311-170	08-311-250	08-311-370

biegsam
 malleable
 malléable
 maleable
 flessibile

REVERDIN

1:2

280 mm – 11 "	46 mm x 60 mm	08-312-280
---------------	---------------	------------

Wundspreizer
Retractors

Ecarteurs
Separadores
Divaricatori



SULLIVAN-C•NN•R

Fig. 1	Fig. 2	Fig. 3	Set
45 mm x 17 mm	90 mm x 37 mm	90 mm x 45 mm	Fig. 1, 2, 3
08-313-001	08-313-002	08-313-003	08-314-000

komplett
complete
complet
completo
completo



FRIEDMANN

100 mm – 4"

08-315-100

**laminektomiesperrer
Laminectomy retractors**

**Ecarteurs pour laminectomie
Separadores para laminectomía
Divaricatori per laminectomia**



CL • WARD

160 mm – 6 ¼ "	250 mm – 9 ¾ "
08-316-000	08-317-000

komplett mit je 2 Valven Fig. 1 - Fig. 5
complete with 2 blades ea. Fig. 1 - Fig. 5
complet avec 2 valves chacune Fig. 1 - Fig. 5
completo con 2 valvas de cada Fig. 1 - Fig. 5
completo con 2 valve Fig. 1 - Fig. 5

komplett mit je 2 Valven Fig. 1 - Fig. 5
complete with 2 blades ea. Fig. 1 - Fig. 5
complet avec 2 valves chacune Fig. 1 - Fig. 5
completo con 2 valvas de cada Fig. 1 - Fig. 5
completo con 2 valve Fig. 1 - Fig. 5

08-316-010	08-317-010
------------	------------

Sperrer ohne Valven
Retractor without blades
Ecarteur sans valves
Separador sin valvas
Divaricatore senza valve

Sperrer ohne Valven
Retractor without blades
Ecarteur sans valves
Separador sin valvas
Divaricatore senza valve

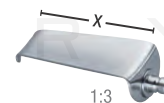
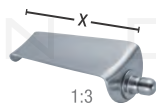

x = 40 mm	08-316-400
x = 45 mm	08-316-450
x = 50 mm	08-316-500
x = 55 mm	08-316-550
x = 60 mm	08-316-600

x = 40 mm	08-317-400
x = 45 mm	08-317-450
x = 50 mm	08-317-500
x = 55 mm	08-317-550
x = 60 mm	08-317-600

stumpf
blunt
mousse
romo
smusso

gezahnt
toothed
dentelée
dentada
dentata

laminektomiesperrer
Laminectomy retractors

Ecarteurs pour laminectomie
Separadores para laminectomía
Divaricatori per laminectomia



INGE 1:3

1:3

165 mm – 6 ½ "	270 mm – 10 ¾ "
08-318-170	08-318-270



CL•WARD-
VERTEBRA

1:2

160 mm – 6 ¼ "	08-319-160
----------------	------------

laminektomiesperrer
Laminectomy retractors

Ecarteurs pour laminectomie
Separadores para laminectomía
Divaricatori per laminectomia

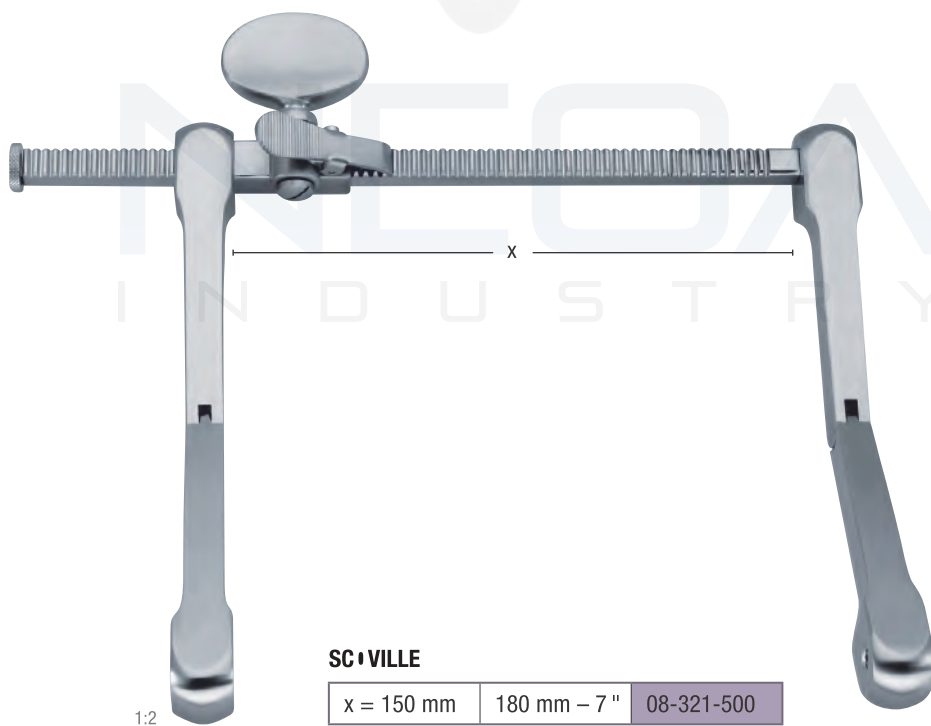
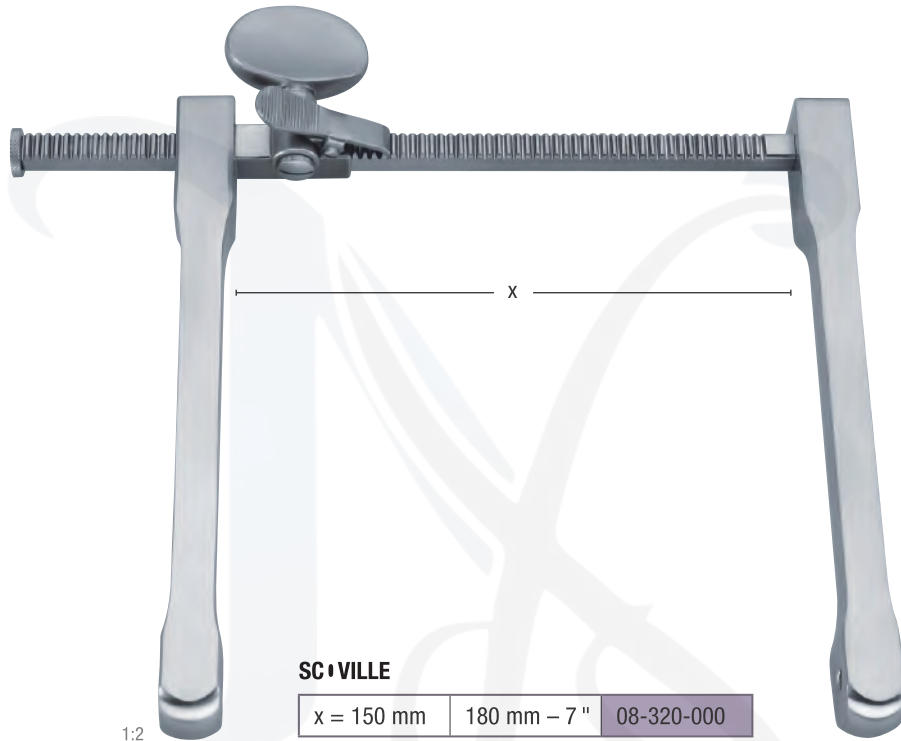

laminektomiesperrer
Laminectomy retractors

Ecarteurs pour laminectomie
Separadores para laminectomía
Divaricatori per laminectomia

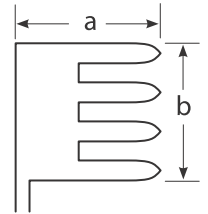

SC•VILLE

50 mm – 2"	08-321-010	08-321-060
70 mm – 2 ¾"	08-321-020	08-321-070

stumpf
blunt
mousse
romo
smusso

spitz
sharp
pointu
aguda
acuta

TAYL•R

a = 48 mm – b = 50 mm – 2" x 2"	08-321-410
a = 63 mm – b = 50 mm – 2½" x 2"	08-321-420
a = 64 mm – b = 64 mm – 3¼" x 2¼"	08-321-430
a = 80 mm – b = 57 mm – 3" x 2"	08-321-440



SC•VILLE

a = 40 mm – b = 37 mm – 1½" x 1½"	08-321-460
a = 65 mm – b = 44 mm – 2½" x 1¾"	08-321-470



TAYL•R

a = 75 mm – b = 32 mm – 3" x 1¼"	08-321-532
a = 100 mm – b = 42 mm – 4" x 1⅝"	08-321-542

laminektomiesperrer
Laminectomy retractors

Ecarteurs pour laminectomie
Separadores para laminectomía
Divaricatori per laminectomia

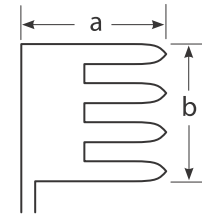

MEYERDING

a = 57 mm – b = 25 mm – 2¼" x 1"	08-321-557
a = 76 mm – b = 25 mm – 3" x 1"	08-321-576
a = 88 mm – b = 51 mm – 3½" x 2"	08-321-588



SC-VILLE

a = 64 mm – b = 25 mm – 2½" x 1"	08-321-110
a = 64 mm – b = 50 mm – 2½" x 2"	08-321-120
a = 88 mm – b = 25 mm – 3½" x 1"	08-321-130



EPSTEIN

1:2

a = 56 mm – b = 25 mm – 2¼" x 1"	08-321-656
----------------------------------	------------



HIBBS

a = 50 mm – b = 20 mm – 2" x ¾"	08-322-001
a = 50 mm – b = 25 mm – 2" x 1"	08-322-002
a = 50 mm – b = 50 mm – 2" x 2"	08-322-003
a = 63 mm – b = 25 mm – 2½" x 1"	08-322-004
a = 63 mm – b = 37 mm – 2½" x 1½"	08-322-005
a = 76 mm – b = 25 mm – 3" x 1"	08-322-006
a = 76 mm – b = 38 mm – 3" x 1½"	08-322-007
a = 76 mm – b = 50 mm – 3" x 2"	08-322-008
a = 76 mm – b = 63 mm – 3" x 2½"	08-322-009
a = 90 mm – b = 25 mm – 3½" x 1"	08-322-010
a = 90 mm – b = 37 mm – 3½" x 1½"	08-322-011
a = 102 mm – b = 25 mm – 4" x 1"	08-322-012
a = 102 mm – b = 50 mm – 4" x 2"	08-322-013

**laminektomiesperrer
Laminectomy retractors**

*Ecarteurs pour laminectomie
Separadores para laminectomía
Divaricatori per laminectomia*

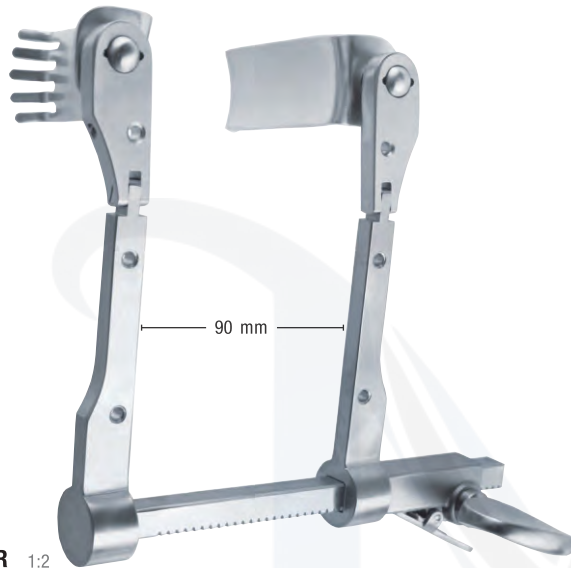

CASPAR 1:2

08-323-000

komplett mit 5 medial Valven 08-324-400 – 08-324-600
und mit 5 lateral Valven 08-325-400 – 08-325-600
complete with 5 medial blades 08-324-400 – 08-324-600
and with 5 lateral blades 08-325-400 – 08-325-600
complet avec 5 valves médianes 08-324-400 – 08-324-600
et avec 5 valves latérales 08-325-400 – 08-325-600
completo con 5 valvas mediales 08-324-400 – 08-324-600
y con 5 valvas laterales 08-325-400 – 08-325-600
completo con 5 valve mediali 08-324-400 – 08-324-600
e con 5 valve laterali 08-325-400 – 08-325-600



1:2

318-721-000

komplett mit 5 Valven 08-326-450 – 08-326-650
complete with 5 blades 08-326-450 – 08-326-650
complet avec 5 valves 08-326-450 – 08-326-650
completo con 5 valvas 08-326-450 – 08-326-650
completo con 5 valve 08-326-450 – 08-326-650

08-323-120

Sperrer ohne Valven
Retractor without blades
Ecarteur sans valves
Separador sin valvas
Divaricatore senza valve

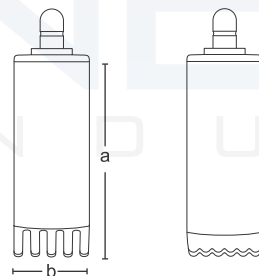

CASPAR

	medial	lateral
a = 40 mm – b = 23 mm	08-324-400	08-325-400
a = 45 mm – b = 23 mm	08-324-450	08-325-450
a = 50 mm – b = 23 mm	08-324-500	08-325-500
a = 55 mm – b = 23 mm	08-324-550	08-325-550
a = 60 mm – b = 23 mm	08-324-600	08-325-600

318-721-110

Sperrer ohne Valven
Retractor without blades
Ecarteur sans valves
Separador sin valvas
Divaricatore senza valve



CASPAR

a = 45 mm – b = 23 mm	08-326-450
a = 50 mm – b = 23 mm	08-326-500
a = 55 mm – b = 23 mm	08-326-550
a = 60 mm – b = 23 mm	08-326-600
a = 65 mm – b = 23 mm	08-326-650

stumpf
blunt
mousse
romo
smusso

laminektomiesperrer
Laminectomy retractors

Ecarteurs pour laminectomie
Separadores para laminectomía
Divaricatori per laminectomia



CASPAR

08-327-001

komplett mit 5 Valven 08-326-450 – 08-326-650
complete with 5 blades 08-326-450 – 08-326-650
complet avec 5 valves 08-326-450 – 08-326-650
completo con 5 valvas 08-326-450 – 08-326-650
completo con 5 valve 08-326-450 – 08-326-650

08-327-002

Sperrer ohne Valven
Retractor without blades
Ecarteur sans valves
Separador sin valvas
Divaricatore senza valve



08-327-012

Schlüssel
Key
Clé
Llave
Chiave

laminektomiesperrer
Laminectomy retractors

Ecarteurs pour laminectomie
Separadores para laminectomía
Divaricatori per laminectomia



CASPAR

38 mm	58 mm
318-727-500	318-727-700

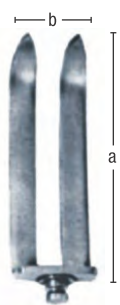

a = 35 mm – b = 22 mm	08-328-350
a = 40 mm – b = 22 mm	08-328-400
a = 45 mm – b = 22 mm	08-328-450
a = 50 mm – b = 22 mm	08-328-500
a = 55 mm – b = 22 mm	08-328-550
a = 60 mm – b = 22 mm	08-328-600
a = 65 mm – b = 22 mm	08-328-650
a = 70 mm – b = 22 mm	08-328-700



a = 35 mm – b = 37 mm	08-327-350
a = 40 mm – b = 37 mm	08-327-400
a = 45 mm – b = 37 mm	08-327-450
a = 50 mm – b = 37 mm	08-327-500
a = 55 mm – b = 37 mm	08-327-550
a = 60 mm – b = 37 mm	08-327-600
a = 65 mm – b = 37 mm	08-327-650
a = 70 mm – b = 37 mm	08-327-700



a = 35 mm – b = 52 mm	08-329-350
a = 40 mm – b = 52 mm	08-329-400
a = 45 mm – b = 52 mm	08-329-450
a = 50 mm – b = 52 mm	08-329-500
a = 55 mm – b = 52 mm	08-329-550
a = 60 mm – b = 52 mm	08-329-600
a = 65 mm – b = 52 mm	08-329-650
a = 70 mm – b = 52 mm	08-329-700

Wundspreizer zur mikrodiskektomie
Retractors for Micro-Lumbar Discectomy

Retracteurs pour la micro discectomie lumbaire

Retractor para la micro discectomía lumbar

Divaricatore per la micro dissezione lombare



CASPAR 1:2

a = 40 mm	08-330-400
a = 45 mm	08-330-450
a = 50 mm	08-330-500
a = 55 mm	08-330-550
a = 60 mm	08-330-600
a = 65 mm	08-330-650
a = 75 mm	08-330-750
a = 85 mm	08-330-850



Mit schwarzer Oberfläche
With black finish
Avec finission noir
Con color negro
Con superficie nera

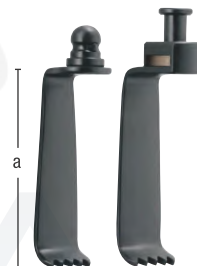

CASPAR

a = 35 mm	08-331-350	
a = 40 mm	08-331-400	08-332-400
a = 45 mm	08-331-450	08-332-450
a = 50 mm	08-331-500	08-332-500
a = 55 mm	08-331-550	08-332-550
a = 60 mm	08-331-600	08-332-600
a = 65 mm	08-331-650	08-332-650
a = 70 mm		08-332-700
a = 75 mm	08-331-750	
a = 85 mm	08-331-850	



CASPAR

08-331-010

1:2



Mit schwarzer Oberfläche
With black finish
Avec finission noir
Con color negro
Con superficie nera

hypophysenspekulum
Speculum for hypophysectomy
Spéculum pour hypophysectomie
Espéculo para hipofisectomía
Specolo per ipofisectomia



Mit schwarzer Oberfläche
 With black finish
 Avec finition noir
 Con color negro
 Con superficie nera



x = 70 mm	08-333-700
x = 90 mm	08-333-900
x = 110 mm	08-334-100

Spekulum für trans-sphenoidale Hypophysectomie
 Speculum for trans-sphenoidal hypophysectomy
 Spéculum pour hypophysectomie trans-sphenoidable
 Espéculo para hipofisectomía transfenoidal
 Specolo per ipofisectomia trans-sfenoidale

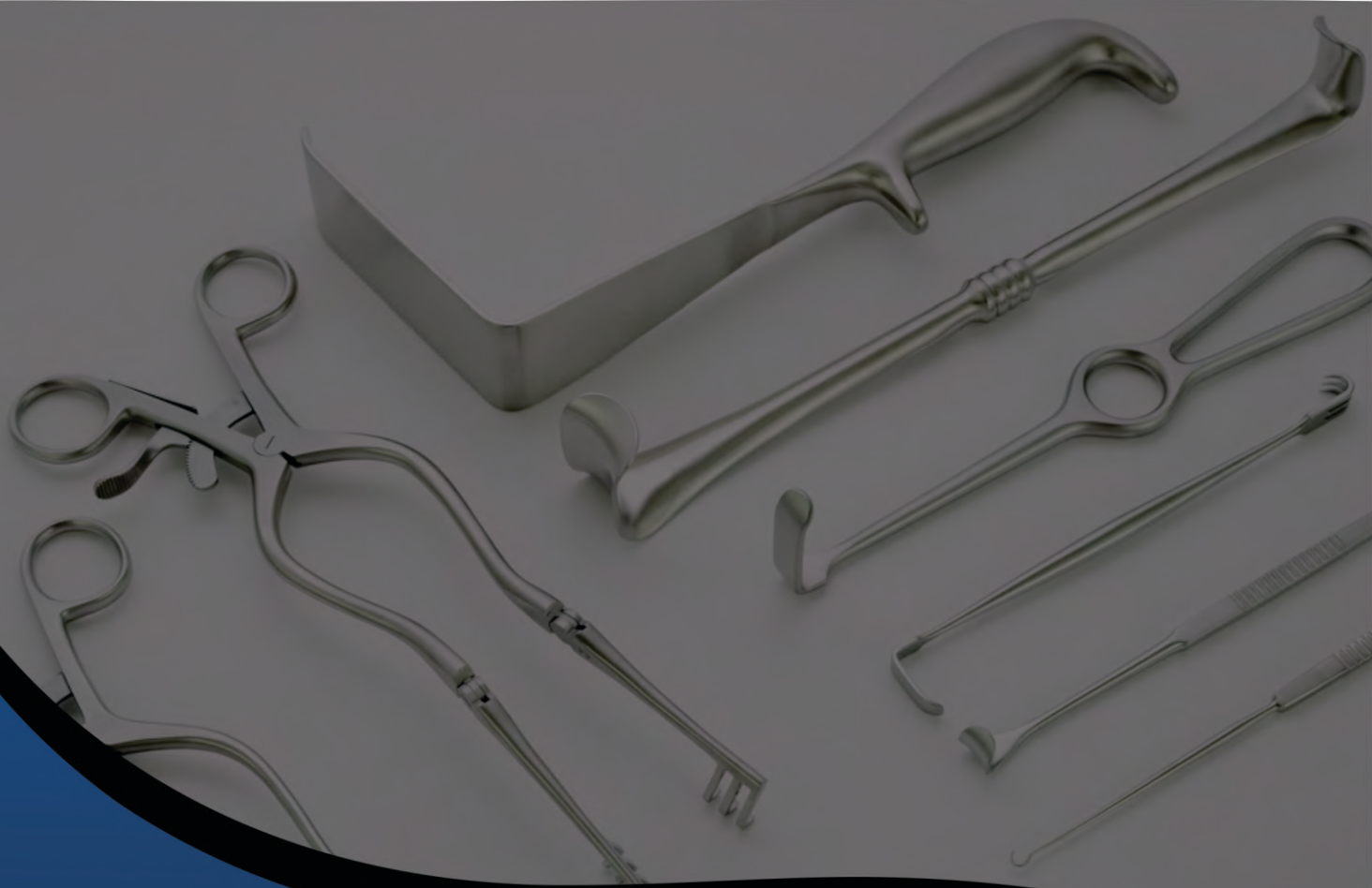

Manufacturer & Supplier Premium Quality Surgical, Dental, Podiatry, Pet Grooming and Beauty Care Instruments.

USA Address:

📍 5900 Balcones Drive # 16244
Austin TX, USA 78731.
☎ +1 (917) 773 3694
📞 **uk:** +44 7871 836765
✉ info@neoaindustry.com
neoaindustry4@gmail.com
🌐 www.neoaindustry.com

Main Head Office:

📍 Roars Road New Miana Pura
West, Sialkot 51310 Pakistan.
☎ +92 322 5587688
📞 +92 322 5587688
✉ info@neoaindustry.com
neoaindustry4@gmail.com
🌐 www.neoaindustry.com

