

» Magen, Darm, Rektum

» Stomach, Intestines, Rectum

» Estomac, Intestins, Rectum

» Estómago, Intestinos, Recto

» Stomaco, Intestini, Retto



### Gewebe- und Darmfasszangen Tissue and intestinal holding forceps

*Pinces intestinales et de tissue*  
*Pinzas para tejidos y intestinos*  
*Pinze per tessuti ed intestinali*



**ALLIS**

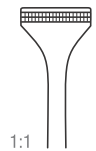
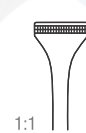

			Atrauma	Atrauma	Atrauma	Atrauma
155 mm – 6 "	16-101-155	16-102-155	16-103-160			
190 mm – 7 ½ "		16-102-190				
200 mm – 8 "				16-103-200		
230 mm – 9 "		16-102-230				
250 mm – 9 ¾ "					16-103-250	
300 mm – 12 "						16-103-300

Zähne  
Teeth  
Dents  
Dientes  
Denti

4 x 5

5 x 6



1:2

**ALLIS-BABY**

140 mm – 5 ½ "	16-104-140
----------------	------------

Zähne  
Teeth  
Dents  
Dientes  
Denti

4 x 5



1:2

**ALLIS-ADAIR**

155 mm – 6 "	16-105-150
--------------	------------

Zähne  
Teeth  
Dents  
Dientes  
Denti

10 x 11



1:3

**THOMS-ALLIS**

200 mm – 8 "	16-106-200
--------------	------------

Zähne  
Teeth  
Dents  
Dientes  
Denti

6 x 7

Gewebe- und Darmfasszangen  
*Tissue and intestinal holding forceps*

*Pinces intestinales et de tissue*  
*Pinzas para tejidos y intestinos*  
*Pinze per tessuti ed intestinali*



**BOYS-ALLIS**

1:2

150 mm – 6 "	16-107-150
--------------	------------

Zähne  
 Teeth  
 Dents  
 Dientes  
 Denti

5 x 6



**JUDD-ALLIS**

150 mm – 6 "	16-108-150
190 mm – 7 ½ "	16-108-190

Zähne  
 Teeth  
 Dents  
 Dientes  
 Denti

3 x 4

Gewebe- und Darmfazzangen  
Tissue and intestinal holding forceps

*Pinces intestinales et de tissue*  
*Pinzas para tejidos y intestinos*  
*Pinze per tessuti ed intestinali*



1:2

**LITTLEWOOD**

185 mm – 7 ¼ " 16-109-185

Zähne  
Teeth  
Dents  
Dientes  
Denti

2 x 3



1:1

1:3

**LOCKWOOD**

200 mm – 8 " 16-110-200



1:1

1:2

**WILLIAMS**

160 mm – 6 ¼ " 16-111-160



NEOA  
INDUSTRY



1:1



1:1

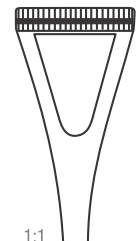

1:1

**BABCOCK**

		TC	TC	Atrauma	Atrauma
160 mm – 6 ¼ "	16-112-160	16-113-160		16-114-160	
180 mm – 7 "	16-112-180		16-113-180		
200 mm – 8 "	16-112-195		16-113-200		16-114-200
240 mm – 9 ½ "	16-112-240				



Gewebe- und Darmfasszangen  
*Tissue and intestinal holding forceps*

*Pinces intestinales et de tissue*  
*Pinzas para tejidos y intestinos*  
*Pinze per tessuti ed intestinali*

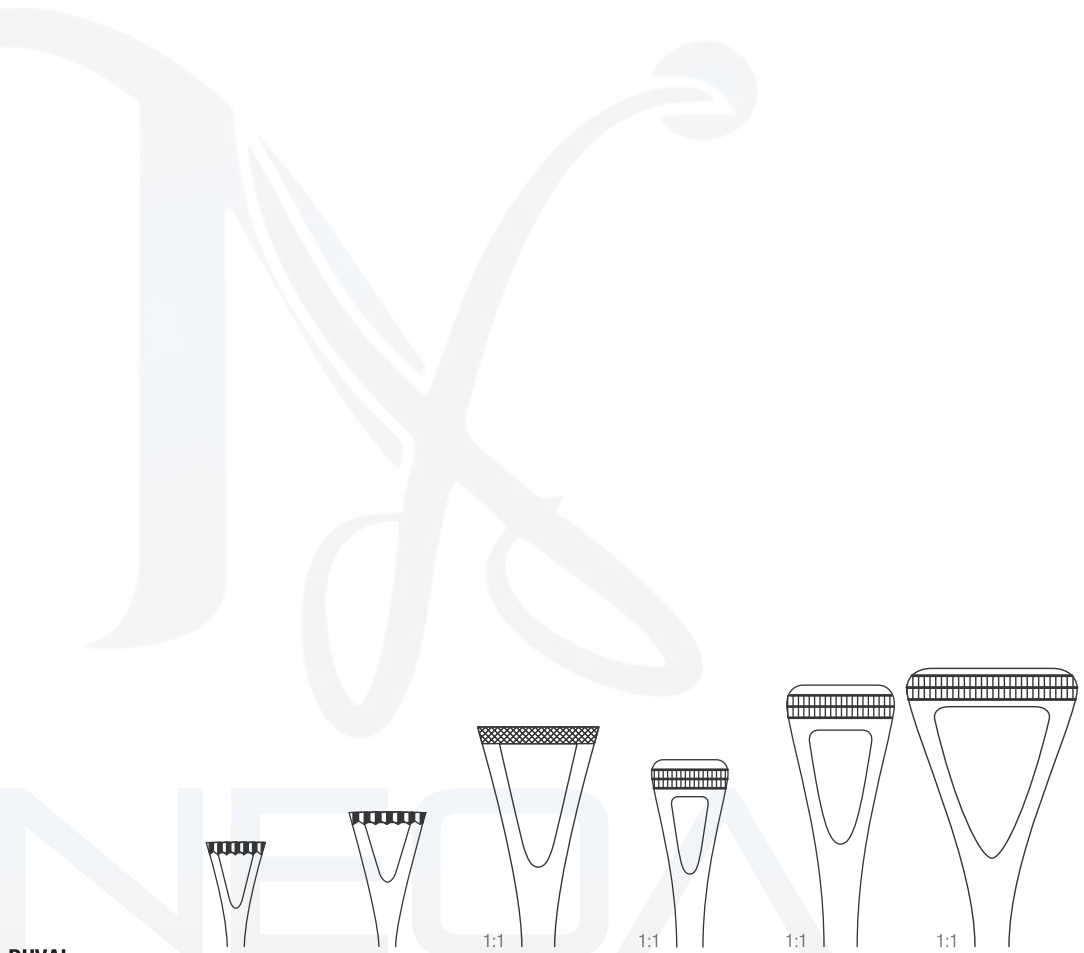

**DUVAL**

			TC	Atrauma	Atrauma	Atrauma
180 mm – 7 "	16-115-180			16-149-180		
200 mm – 8 "	16-117-014	16-117-028	16-119-200		16-149-200	
230 mm – 9 "		16-118-230				16-149-230



### Darm- und Magenklammern Intestinal and stomach clamps

*Pinces-clamps pour l'intestin et l'estomac*  
*Pinzas-clamps para el intestino y el estómago*  
*Pinze per intestino e stomaco*



1:2

**BABY-KOCHER**

1:1



1:1

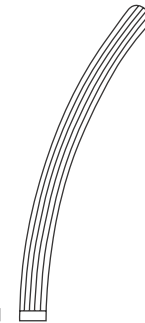

130 mm – 5 "	16-121-130	16-122-130
--------------	------------	------------

Darmklemme für Kinder, sehr elastisch  
Intestinal clamp for children, very elastic blades  
Pince intestinal pour enfants, très élastique  
Pinza intestinal para niños, muy elástica  
Pinza intestinale per bambini, molto elastica



1:2

**ALLEN**

1:1



155 mm – 6 "	16-123-160
200 mm – 8 "	16-123-200

Zähne  
Teeth  
Dents  
Dientes  
Denti

1 x 2

Darmklemme für Kinder  
Intestinal clamp for children  
Pince intestinal pour enfants  
Pinza intestinal para niños  
Pinza intestinale per bambini

### Darm- und Magenklammern Intestinal and stomach clamps

*Pinces-clamps pour l'intestin et l'estomac*  
*Pinzas-clamps para el intestino y el estómago*  
*Pinze per intestino e stomaco*



1:2  
**BABY-DOYEN**

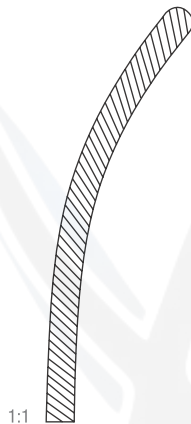
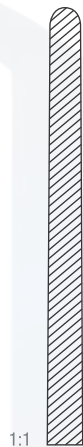

180 mm – 7 "	16-124-180	16-125-180
210 mm – 8 ¼ "	16-124-210	16-125-210

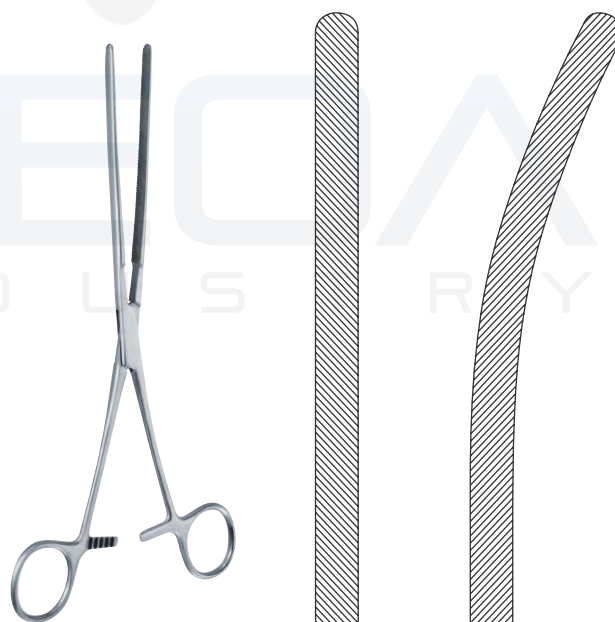

1:3  
**DOYEN**

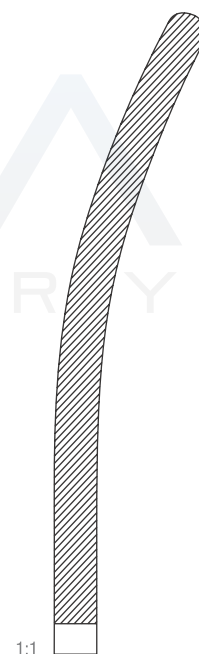

230 mm – 9 "	16-126-230	16-127-230
--------------	------------	------------

Darm- und Magenklammern  
*Intestinal and stomach clamps*

*Pinces-clamps pour l'intestin et l'estomac*  
*Pinzas-clamps para el intestino y el estómago*  
*Pinze per intestino e stomaco*

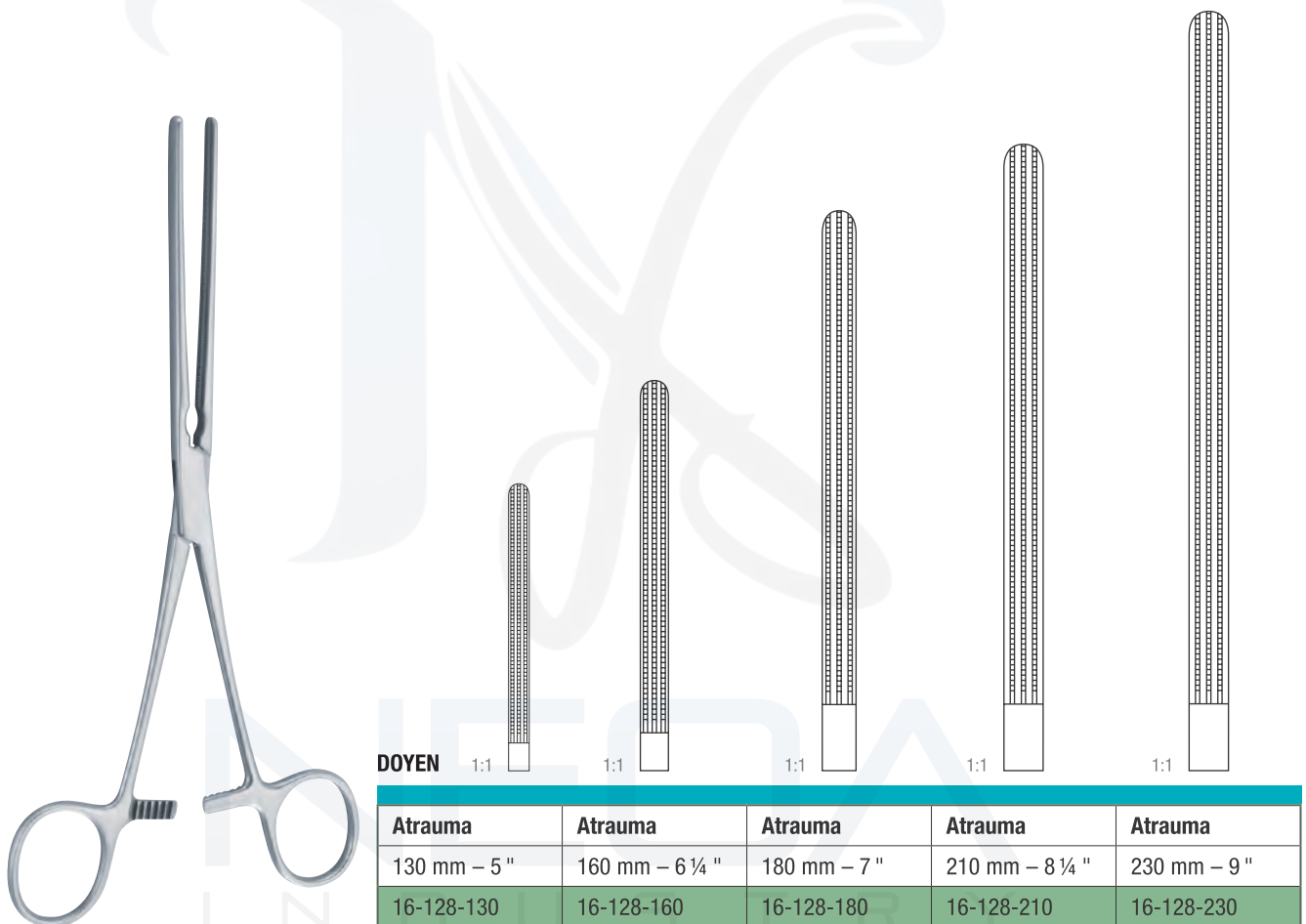

**DOYEN**

1:1

1:1

1:1

1:1

1:1

Atrauma	Atrauma	Atrauma	Atrauma	Atrauma
130 mm – 5 "	160 mm – 6 ¼ "	180 mm – 7 "	210 mm – 8 ¼ "	230 mm – 9 "
16-128-130	16-128-160	16-128-180	16-128-210	16-128-230



**Darm- und Magenklammern**  
**Intestinal and stomach clamps**

*Pinces-clamps pour l'intestin et l'estomac*  
*Pinzas-clamps para el intestino y el estómago*  
*Pinze per intestino e stomaco*



**DOYEN**

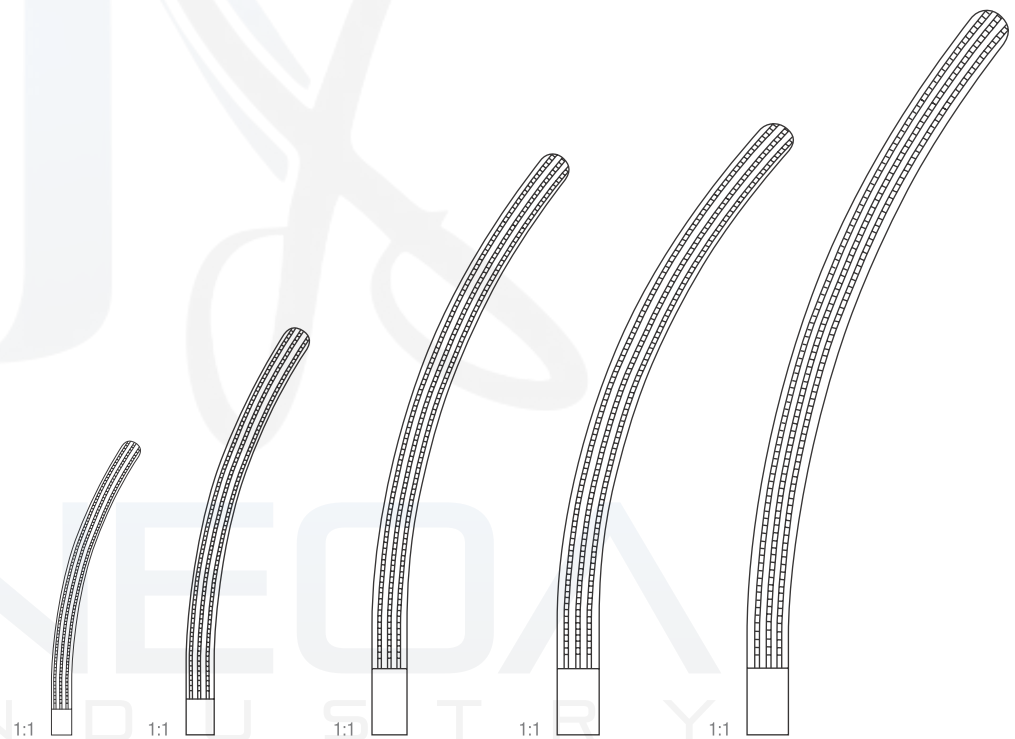

Atrauma	Atrauma	Atrauma	Atrauma	Atrauma
130 mm – 5 "	160 mm – 6 ¼ "	180 mm – 7 "	210 mm – 8 ¼ "	230 mm – 9 "
16-129-130	16-129-160	16-129-180	16-129-210	16-129-230

**Darm- und Magenklammern**  
**Intestinal and stomach clamps**

*Pinces-clamps pour l'intestin et l'estomac*  
*Pinzas-clamps para el intestino y el estómago*  
*Pinze per intestino e stomaco*

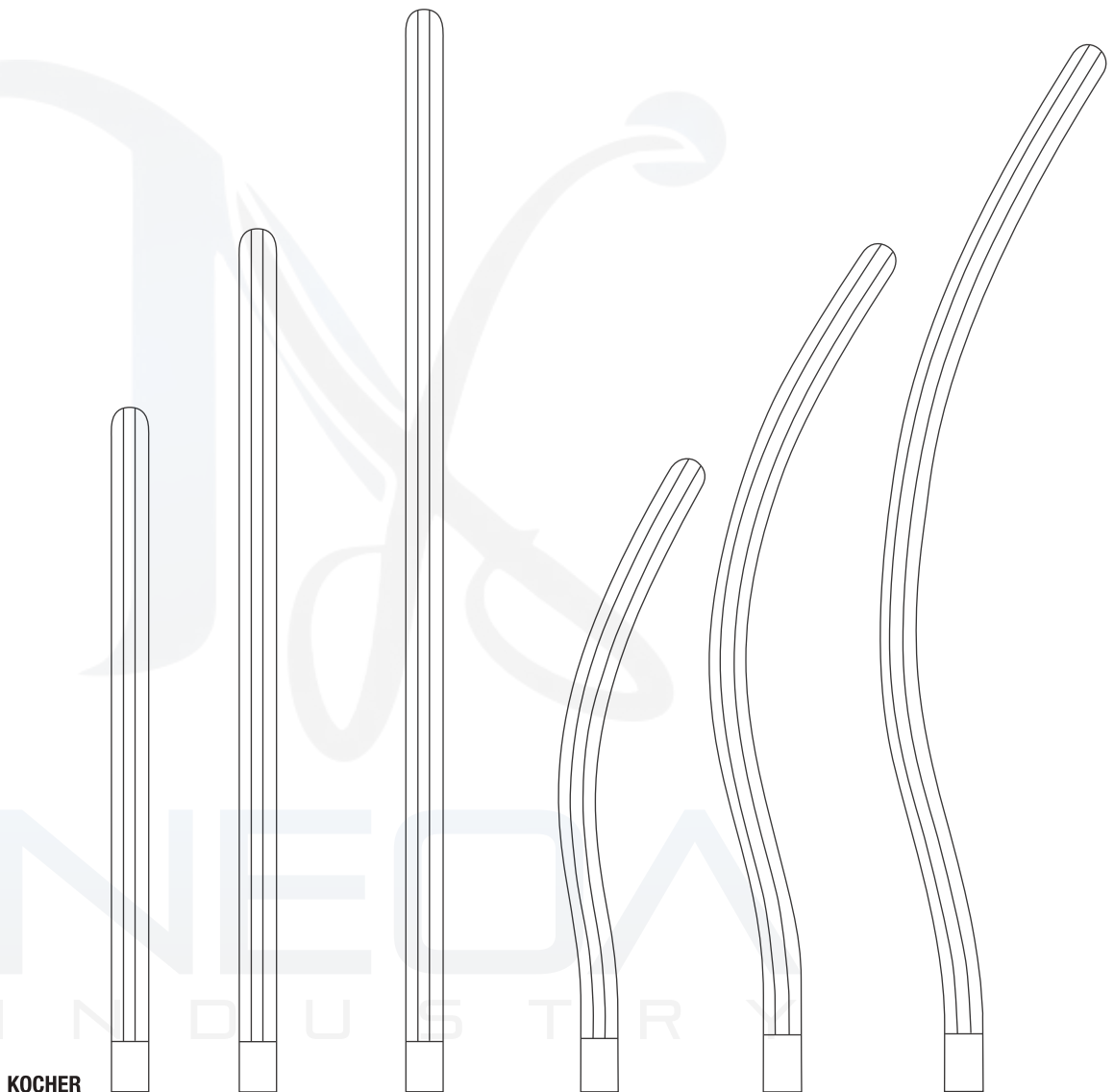

**KOCHER**

220 mm – 8 ¾ "	250 mm – 9 ¾ "	280 mm – 11 "	220 mm – 8 ¾ "	250 mm – 9 ¾ "	280 mm – 11 "
16-130-220	16-130-250	16-130-280	16-131-220	16-131-250	16-131-280

Darm- und Magenklammern  
*Intestinal and stomach clamps*

*Pinces-clamps pour l'intestin et l'estomac*  
*Pinzas-clamps para el intestino y el estómago*  
*Pinze per intestino e stomaco*



**KOCHER**

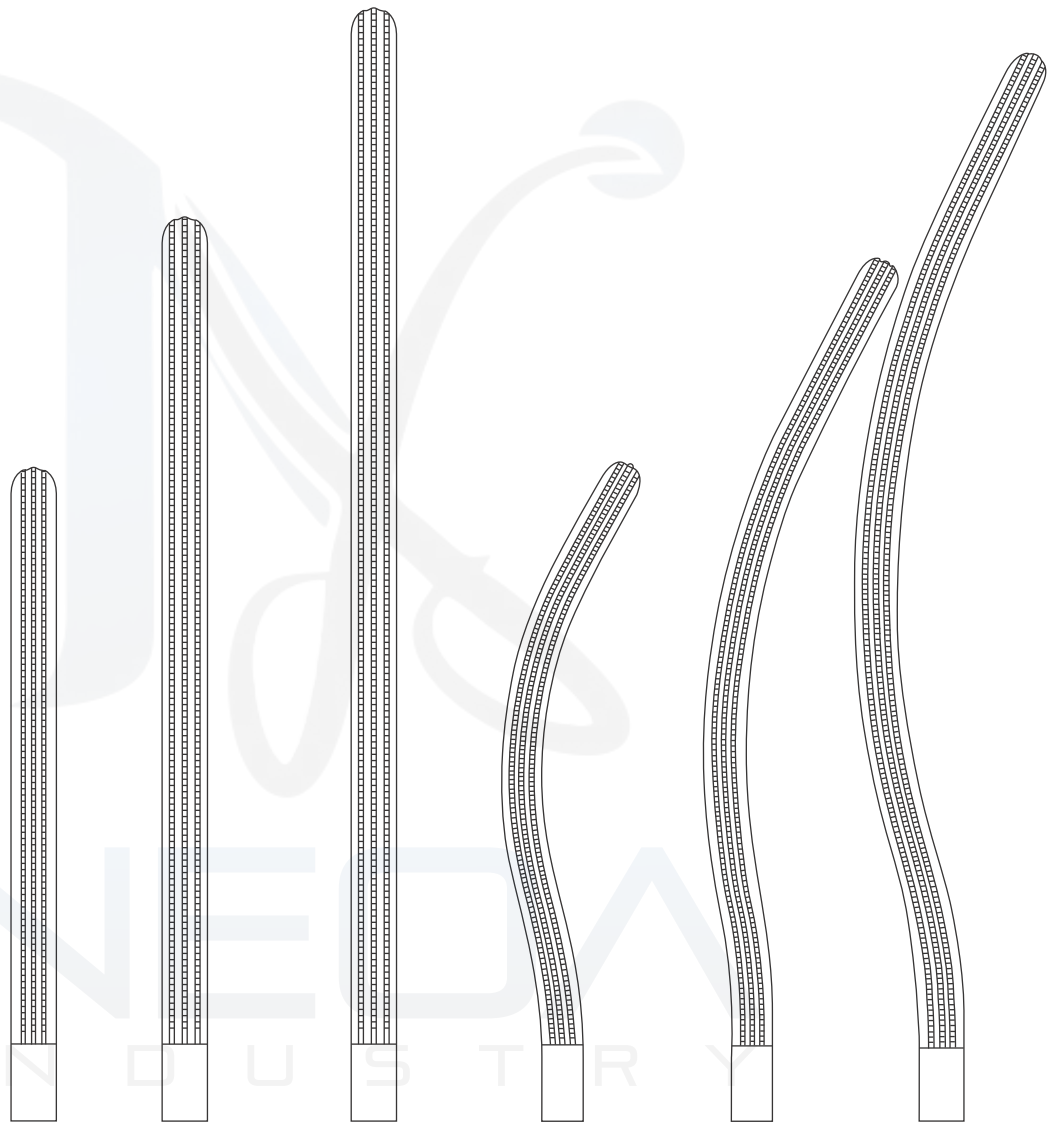

Atrauma	Atrauma	Atrauma	Atrauma	Atrauma	Atrauma
220 mm – 8 ¾ "	250 mm – 9 ¾ "	280 mm – 11 "	220 mm – 8 ¾ "	250 mm – 9 ¾ "	280 mm – 11 "
16-132-220	16-132-250	16-132-280	16-133-220	16-133-250	16-133-280

**Darm- und Magenklammern**  
**Intestinal and stomach clamps**

*Pinces-clamps pour l'intestin et l'estomac*  
*Pinzas-clamps para el intestino y el estómago*  
*Pinze per intestino e stomaco*



1:2  
**MAYO-ROBSON**

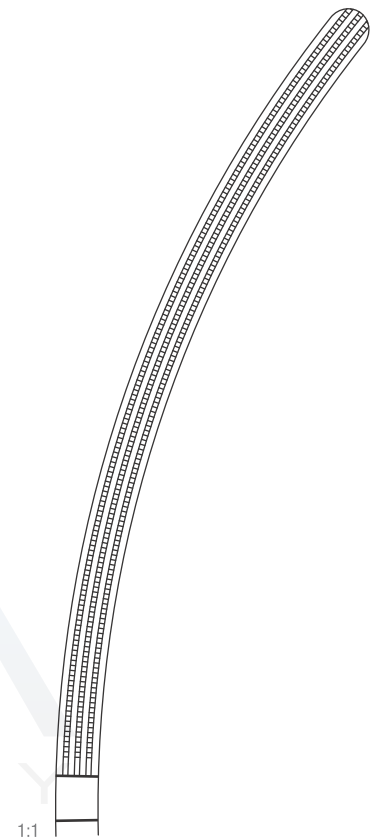
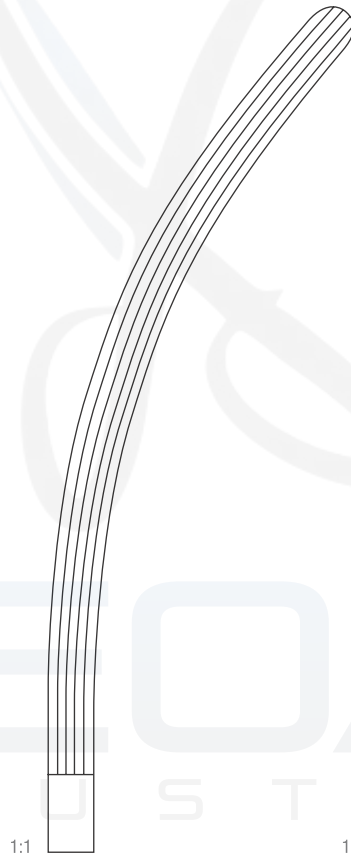

			Atrauma	Atrauma
230 mm – 9"	16-134-230	16-135-230		
250 mm – 9¾"	16-136-250	16-137-250	16-138-250	16-139-250



Darm- und Magenklammern  
*Intestinal and stomach clamps*

*Pinces-clamps pour l'intestin et l'estomac*  
*Pinzas-clamps para el intestino y el estómago*  
*Pinze per intestino e stomaco*



1:2

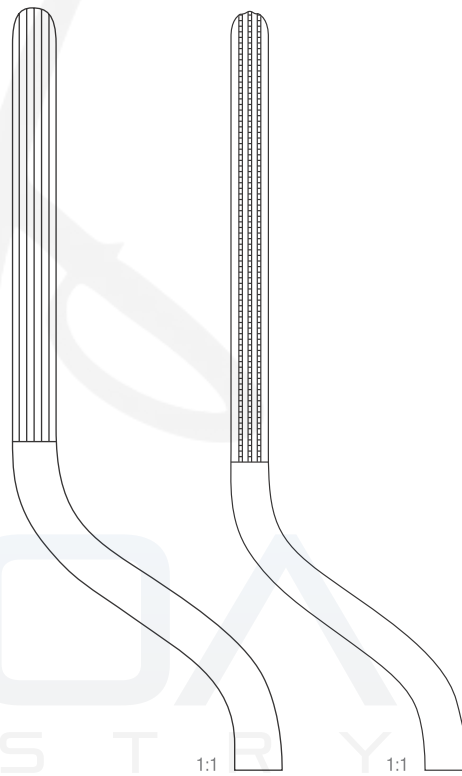

1:1

1:1

**BRUNNER**

		<b>Atrauma</b>
240 mm – 9 ½ "	16-140-240	16-141-240



Darm- und Magenklammern  
*Intestinal and stomach clamps*

*Pinces-clamps pour l'intestin et l'estomac*  
*Pinzas-clamps para el intestino y el estómago*  
*Pinze per intestino e stomaco*



Darm- und Magenklammern  
*Intestinal and stomach clamps*

*Pinces-clamps pour l'intestin et l'estomac*  
*Pinzas-clamps para el intestino y el estómago*  
*Pinze per intestino e stomaco*

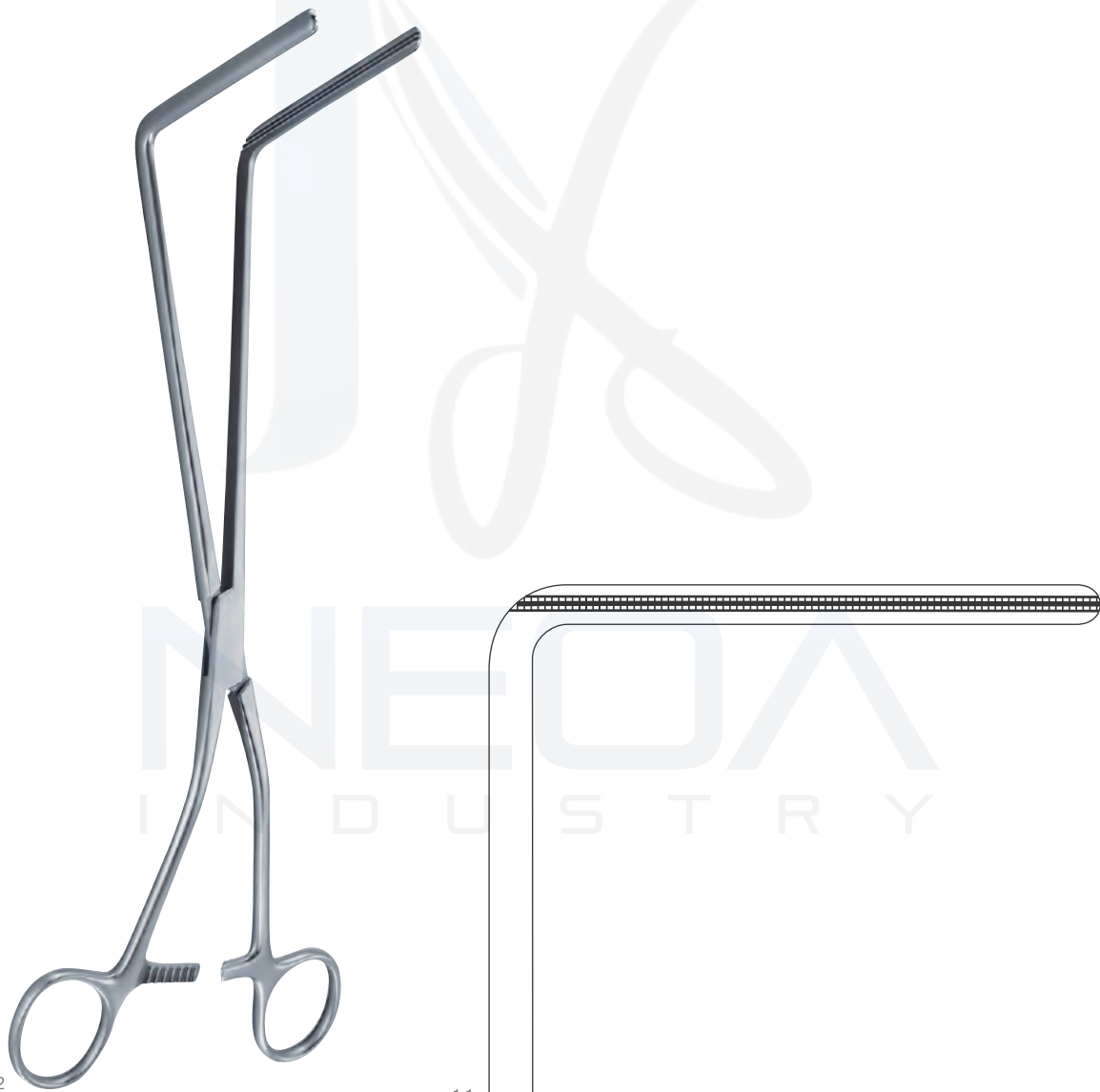

1:2

**RESANO**

1:1

	<b>Atrauma</b>
300 mm – 12"	16-144-300

### Rektum-Anastomosenklemmen *Sigmoid anastomosis forceps*

*Pinces pour anastomoses rectales*  
*Pinzas para anastomosis rectales*  
*Pinze per anastomosi rettali*

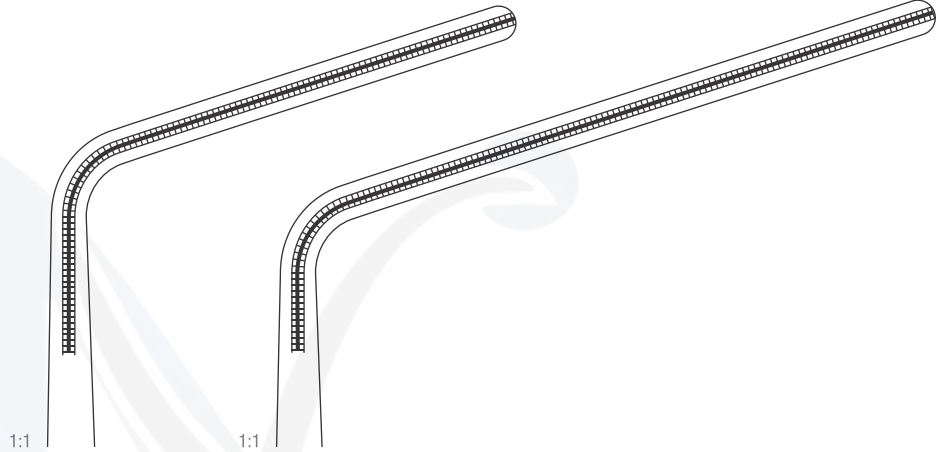

#### HAYES

Atrauma	Atrauma
260 mm – 10 ¼ "	280 mm – 11 "
16-145-260	16-145-280



#### FEHLANT

		Atrauma
230 mm – 9 "	16-146-230	16-147-230

1:2



organfasszangen  
*Organ grasping forceps*

*Pinces pour saisir des organes*  
*Pinzas para sacar órganos*  
*Pinze per afferrare organi*



1:2

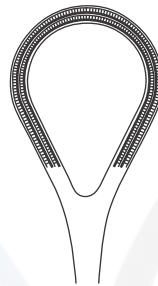

Atrauma	
250 mm – 9 3/4 "	16-148-250

Organfasszange mittel, 250 mm  
 Organ grasping forceps medium, 250 mm  
 Pince medium pour saisir des organes, 250 mm  
 Pinza mediano para sacar órganos, 250 mm  
 Pinze per afferrare organi, 250 mm

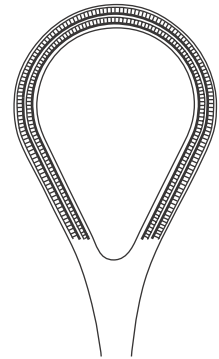

Atrauma	
260 mm – 10 1/4 "	16-148-260

Organfasszange mittel, 250 mm  
 Organ grasping forceps medium, 250 mm  
 Pince medium pour saisir des organes, 250 mm  
 Pinza mediano para sacar órganos, 250 mm  
 Pinze per afferrare organi, 250 mm



1:2



SCHEIBE

Atrauma	Atrauma	Atrauma
180 mm – 7 "	200 mm – 8 "	230 mm – 9 "
16-149-180	16-149-200	16-149-230

schmal  
 narrow  
 étroit  
 estrecho  
 stretto

mittel  
 medium  
 moyen  
 mediano  
 medio

breit  
 wide  
 large  
 ancho  
 largo

### Darmquetschklemmen Intestinal and pylorus clamps

*Ecraseur pour l'intestin*  
*Pinzas intestinales para piloro*  
*Schiacciatori intestinali*



1:2

**PAYR-BABY**

150 mm – 6 "

16-150-150

mit Stift  
with pin  
avec cheville  
con perno  
con perno



1:1



1:2

**PAYR**

1:1

1:1

1:1

210 mm – 8 ¼ "

290 mm – 11 ½ "

350 mm 13 ¾ "

16-152-210

16-151-290

16-153-350

mit Stift  
with pin  
avec cheville  
con perno  
con perno

**Darm- und Anastomosenklemmen**  
*Intestinal and anastomosis clamp forceps*

*Pinces-clamps intestinales et à anastomose*  
*Pinzas-clamps intestinales y para anastomosis*  
*Pinze intestinali e per anastomosi*



**DE MARTEL-  
WOLFSON**

1:2



85 mm – 3 ¼ "

16-154-085

**DE MARTEL-  
WOLFSON**

1:2



230 mm – 9 "

16-154-230

1:2

**DE MARTEL-  
WOLFSON**



260 mm – 10 ¼ "

16-155-260

Darm- und Anastomosenklemmen  
*Intestinal and anastomosis clamp forceps*

*Pinces-clamps intestinales et à anastomose*  
*Pinzas-clamps intestinales y para anastomosis*  
*Pinze intestinali e per anastomosi*

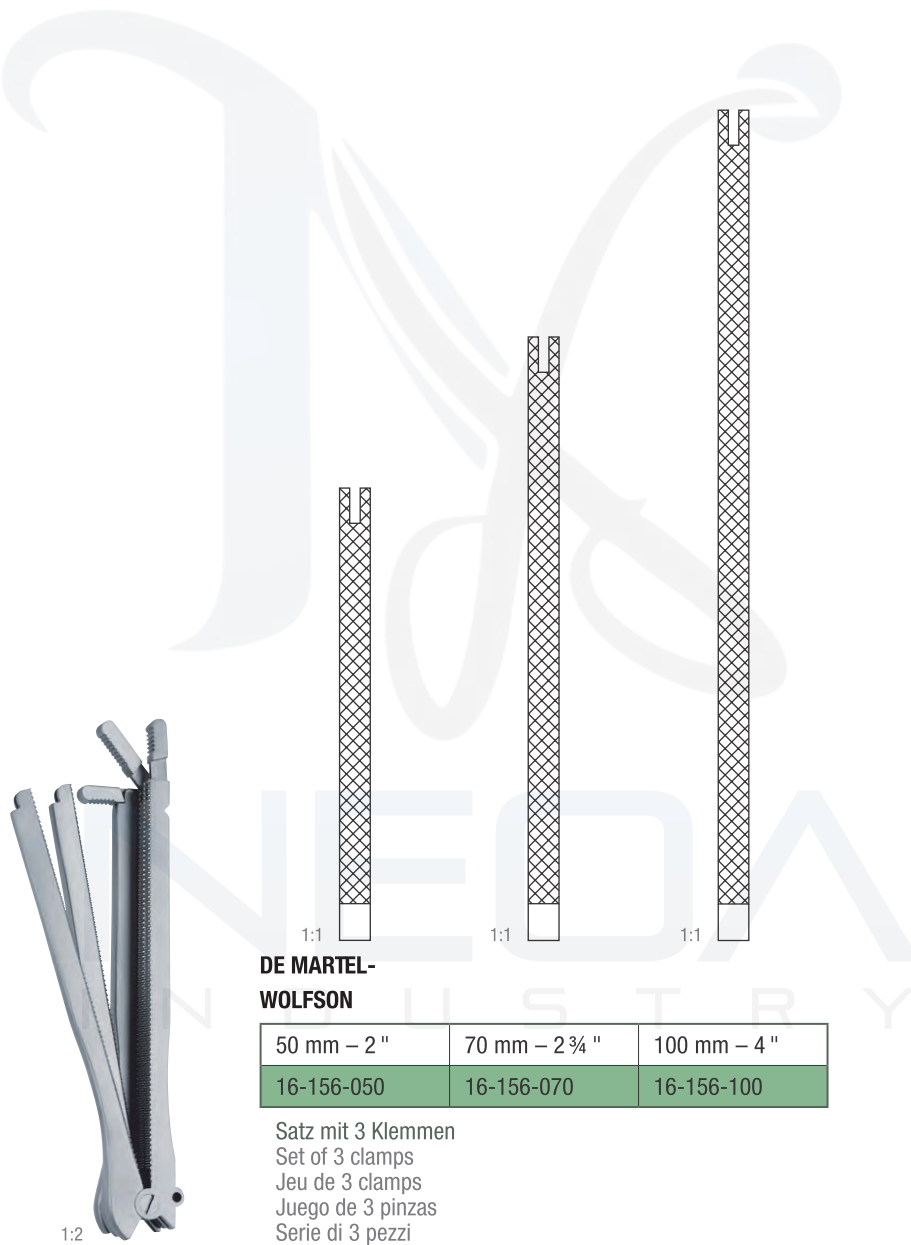

**DE MARTEL-  
WOLFSON**

50 mm – 2 "	70 mm – 2 ¾ "	100 mm – 4 "
16-156-050	16-156-070	16-156-100

Satz mit 3 Klemmen  
 Set of 3 clamps  
 Jeu de 3 clamps  
 Juego de 3 pinzas  
 Serie di 3 pezzi

### Mastdarm-spekula Rectal specula

*Spéculums pour le rectum*  
*Espéculos rectales*  
*Specoli rettali*



**SIMS**

	x = 80 mm x 15 mm	x = 80 mm x 15 mm	x = 80 mm x 15 mm
150 mm – 6 "	16-158-150	16-157-150	16-159-150

mit Kaltlichtaufsatz  
with F.O. light carrier  
avec support lumière froide  
con guía de luz fría  
con supporto per luce fredda



**MATHIEU**

1:2

	x = 90 mm
195 mm – 7 ¾ "	16-160-195

**Mastdarm-spekula**  
**Rectal specula**

*Spéculums pour le rectum*  
*Espéculos rectales*  
*Specoli rettali*



**PRATT**

1:2

	x = 80 mm x 25 mm
205 mm – 8"	16-161-000



**CZERNY**

1:2

	x = 110 mm x 25 mm
220 mm – 8 ¾"	16-162-220

Anuskope – sphinkterskope  
*Anusopes – Sphincteroscopes*  
*Anusopes – Sphinctérosopes*  
*Anoscopios – Esfinteroscopios*  
*Anoscopi – Sfinteroscopi*



**IVES-FANSLER**

1:2

	x = 90 mm	x = 90 mm
22 mm Ø	16-163-220	16-164-650



**KELLY**

	x = 50 mm
21 mm Ø	16-165-001
27 mm Ø	16-165-002

mit Kaltlichtaufsatz  
 with F.O. light carrier  
 avec support lumière froide  
 con guía de luz fría  
 con supporto per luce fredda



**BENSAUDE**

	185 mm – 7 ¼ "
	x = 55 mm
19 mm Ø	16-166-010
22 mm Ø	16-166-020

Anuskope – sphinkterskope  
*Anusopes – Sphincteroscopes*

*Anusopes – Sphinctérosopes*

*Anoscopios – Esfinteroscopios*

*Anoscopi – Sfinteroscopi*



### HIRSCHMANN

16 mm Ø	x = 65 mm	16-167-001
19 mm Ø	x = 65 mm	16-167-002
22 mm Ø	x = 65 mm	16-167-003



### HIRSCHMANN

16 mm Ø	16-168-001
19 mm Ø	16-168-002
24 mm Ø	16-168-003
25 mm Ø	16-168-004

mit Kaltlicht  
 with F.O. light  
 avec lumière froide  
 con de luz fría  
 con per luce fredda

16-169-000

Kaltlichtadapter, ALLGAIER / Storz Anschluss  
 Cold light, ALLGAIER / Storz connector  
 Adaptateur lum. froide, connection ALLGAIER / Storz  
 Adaptador luz fría, conexión ALLGAIER / Storz  
 Adattatore luce freddo, attacco ALLGAIER / Storz



**Analspreizer**  
**Rectal specula**

*Spéculums pour le rectum*  
*Espéculos rectales*  
*Divaricatore anale*



**SMITH-BUIE**

	x = 75 mm x 23 mm
150 mm – 6 "	16-170-150

Max. Spreizweite 115 mm  
Max. spread 115 mm  
Écartement maximal 115 mm  
Apertura máxima 115 mm  
Apertura massima 115 mm

### Analspreizer Rectal specula

*Spéculums pour le rectum*  
*Espéculos rectales*  
*Divaricatore anale*



1:2

#### ALAN PARKS

140 mm – 5 ½ "

16-171-000

komplett mit 2 Paar Valven und 1 Mittelvalve  
complete with 2 pair of blades and 1 center blade  
complet avec 2 paires des valves et 1 valve centrale  
completo con 2 juegos de valvas y 1 valva central  
completo con 2 paia di valve e 1 valva centrale



1:2

#### ALAN PARKS

140 mm – 5 ½ "

16-172-000

komplett mit 2 Paar Valven und 1 Mittelvalve, mit Kaltlichtanschluss ALLGAIER / Wolf  
complete with 2 pair of blades and 1 center blade, with cold light connector ALLGAIER / Wolf  
complet avec 2 paires des valves et 1 valve centrale, avec raccord de lum. froide ALLGAIER / Wolf  
completo con 2 juegos de valvas y 1 valva central, con connector de luz fría ALLGAIER / Wolf  
completo con 2 paia di valve e 1 valva centrale, con attacco di luce fredda ALLGAIER / Wolf

22 mm x 75 mm

16-171-070

Seitenvalven alleine (Paar)  
Lateral blades only (pair)  
Valves latérales seules (paire)  
Valvas laterales solas (par)  
Valve laterali solo (paio)

16-172-002

Kaltlicht-Aufsatz alleine  
F.O. light carrier only  
Support lumière froide seule  
Soporte de luz fría sola  
Supporto per luce fredda solo

22 mm x 95 mm

16-171-090

Seitenvalven alleine (Paar)  
Lateral blades only (pair)  
Valves latérales seules (paire)  
Valvas laterales solas (par)  
Valve laterali solo (paio)

16-171-001

Sperrer alleine  
Specula only  
Speculum seules  
Espéculo sola  
Divaricatore solo

25 mm x 95 mm

16-171-093

Seitenvalven alleine (Paar)  
Lateral blades only (pair)  
Valves latérales seules (paire)  
Valvas laterales solas (par)  
Valve laterali solo (paio)

16-171-002

Mittelvalve alleine  
Central blade only  
Valve centrale seule  
Valva central sola  
Valva centrale solo

### Mastdarm-Biopsiezangen Rectal biopsy forceps

*Pinces pour la biopsie rectale*  
*Pinzas para biopsia rectal*  
*Pinze taglienti per biopsia rettale*

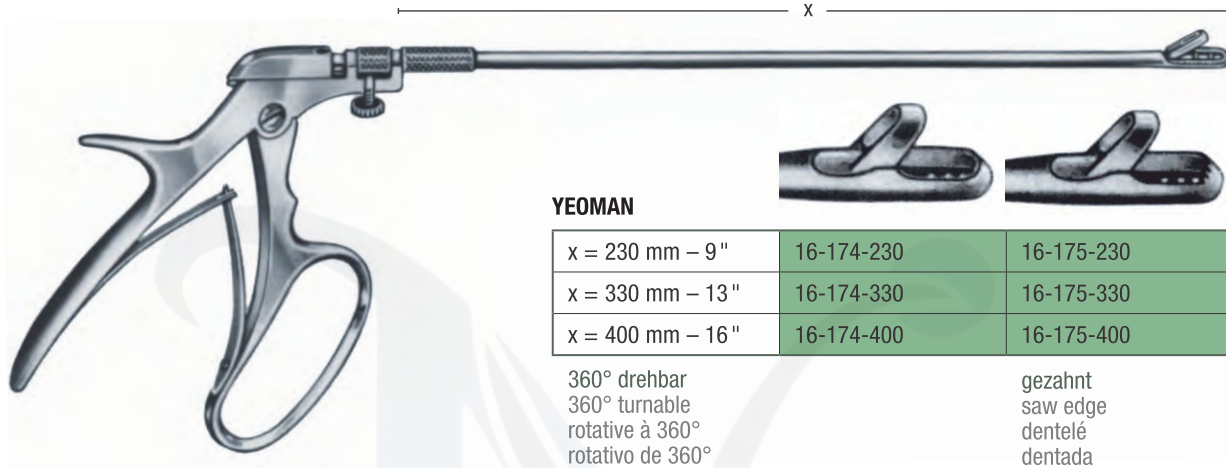

#### YEOMAN

x = 230 mm – 9"	16-174-230	16-175-230
x = 330 mm – 13"	16-174-330	16-175-330
x = 400 mm – 16"	16-174-400	16-175-400

360° drehbar  
360° turnable  
rotative à 360°  
rotativo de 360°  
rotativa di 360°

gezahnt  
saw edge  
dentelé  
dentada  
dentata



#### TURREL

x = 230 mm – 9"	16-176-230	16-177-230
x = 330 mm – 13"	16-176-330	16-177-330
x = 400 mm – 16"	16-176-400	16-177-400

360° drehbar  
360° turnable  
rotative à 360°  
rotativo de 360°  
rotativa di 360°

gezahnt  
saw edge  
dentelé  
dentada  
dentata

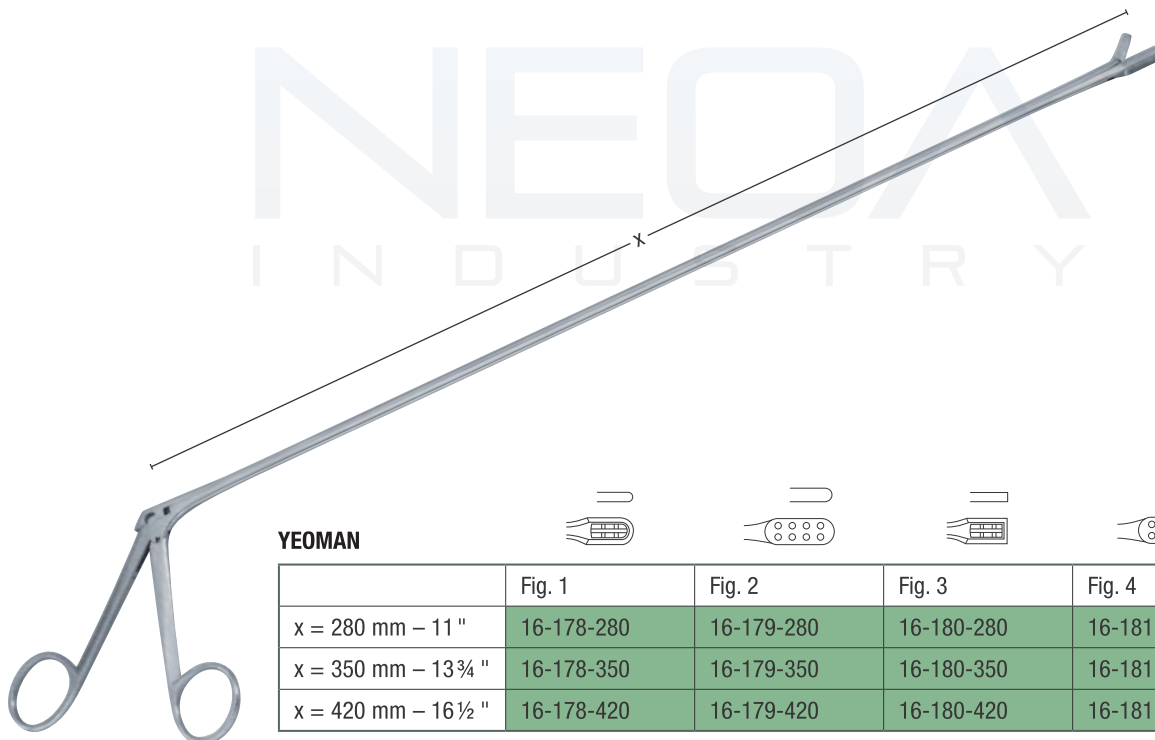

#### YEOMAN



	Fig. 1	Fig. 2	Fig. 3	Fig. 4
x = 280 mm – 11"	16-178-280	16-179-280	16-180-280	16-181-280
x = 350 mm – 13 3/4"	16-178-350	16-179-350	16-180-350	16-181-350
x = 420 mm – 16 1/2"	16-178-420	16-179-420	16-180-420	16-181-420

**Flexible zangen**  
**Flexible forceps**  
**Pinces flexibles**  
**Pinzas flexibles**  
**Pinze flessibili**



	1.8 mm Ø	2.1 mm Ø	2.3 mm Ø	2.5 mm Ø	3.0 mm Ø	3.4 mm Ø
120 cm – 47 ¼"	AFF16-182-120	AFF16-183-120	AFF16-184-120	AFF16-185-120		
160 cm – 63"	AFF16-182-160	AFF16-183-160	AFF16-184-160	AFF16-185-160		
180 cm – 70 ¾"	AFF16-182-180	AFF16-183-180	AFF16-184-180	AFF16-185-180	AFF16-186-180	AFF16-187-180
230 cm – 90 ½"	AFF16-182-230	AFF16-183-230	AFF16-184-230	AFF16-185-230	AFF16-186-230	AFF16-187-230



	1.8 mm Ø	2.1 mm Ø	2.3 mm Ø	2.5 mm Ø	3.0 mm Ø	3.4 mm Ø
120 cm – 47 ¼"	AFF16-188-120	AFF16-189-120	AFF16-190-120	AFF16-191-120		
160 cm – 63"	AFF16-188-160	AFF16-189-160	AFF16-190-160	AFF16-191-160		
180 cm – 70 ¾"	AFF16-188-180	AFF16-189-180	AFF16-190-180	AFF16-191-180	AFF16-192-180	AFF16-193-180
230 cm – 90 ½"	AFF16-188-230	AFF16-189-230	AFF16-190-230	AFF16-191-230	AFF16-192-230	AFF16-193-230



	1.0 mm Ø	1.4 mm Ø	1.6 mm Ø	1.8 mm Ø	2.1 mm Ø	2.3 mm Ø
120 cm – 47 ¼"	AFF16-194-120	AFF16-195-120	AFF16-196-120	AFF16-197-120	AFF16-198-120	AFF16-199-120
160 cm – 63"	AFF16-194-160	AFF16-195-160	AFF16-196-160	AFF16-197-160	AFF16-198-160	AFF16-199-160
180 cm – 70 ¾"	AFF16-194-180	AFF16-195-180	AFF16-196-180	AFF16-197-180	AFF16-198-180	AFF16-199-180
230 cm – 90 ½"	AFF16-194-230	AFF16-195-230	AFF16-196-230	AFF16-197-230	AFF16-198-230	AFF16-199-230



	1.8 mm Ø	2.1 mm Ø	2.3 mm Ø
120 cm – 47 ¼"	AFF16-200-120	AFF16-201-120	AFF16-202-120
160 cm – 63"	AFF16-200-160	AFF16-201-160	AFF16-202-160
180 cm – 70 ¾"	AFF16-200-180	AFF16-201-180	AFF16-202-180
230 cm – 90 ½"	AFF16-200-230	AFF16-201-230	AFF16-202-230



hämorrhoidal-zangen  
*Haemorrhoidal forceps*

*Pinces hémorroidales*  
*Pinzas hemorroidales*  
*Pinze emorroidali*

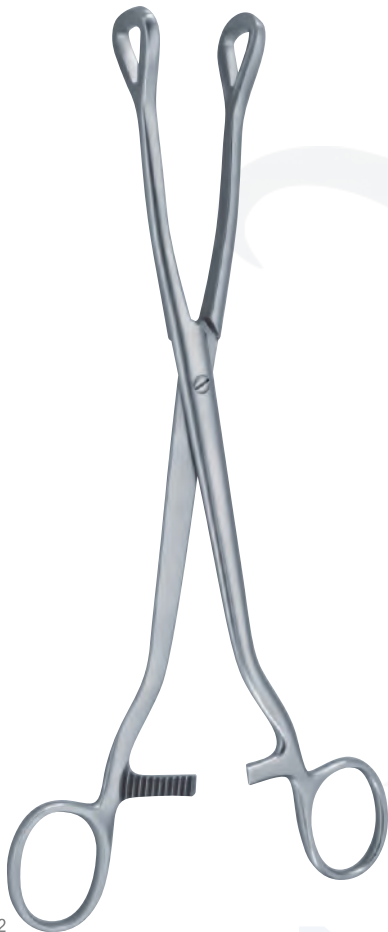

1:2  
LUER

245 mm – 9 ¾ "



16-220-240

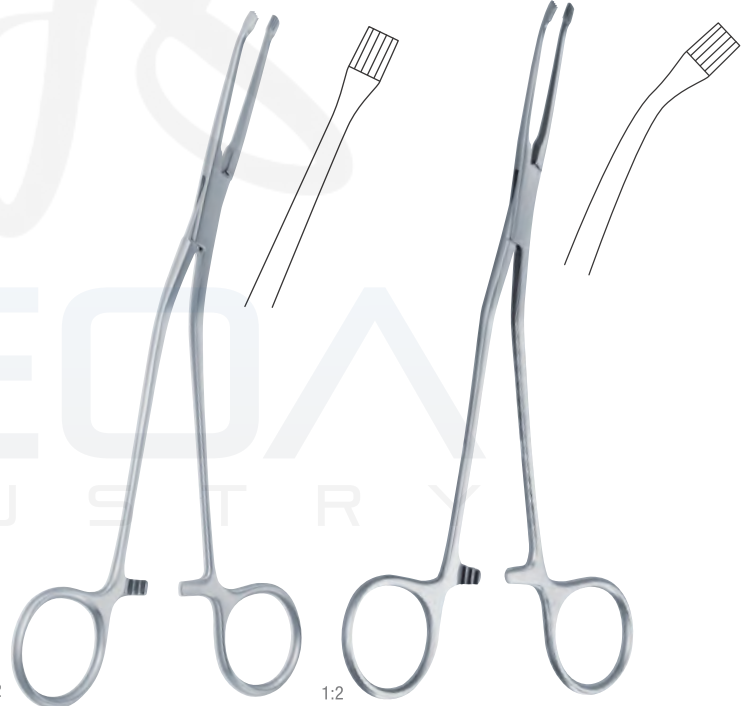

MCGIVNEY

1:2

1:2

190 mm – 7 ½ "

16-221-001

16-221-002

1 x gebogen  
single curved  
courbé simple  
curvado simple  
curvatura singola

2 x gebogen  
double curved  
courbé double  
curvado doble  
curvatura doppia

Polypenfasszangen  
*Polypus grasping forceps*

*Pinces pour saisir les polypes*

*Pinzas para coger pólipos*

*Pinze per afferrare polipi*

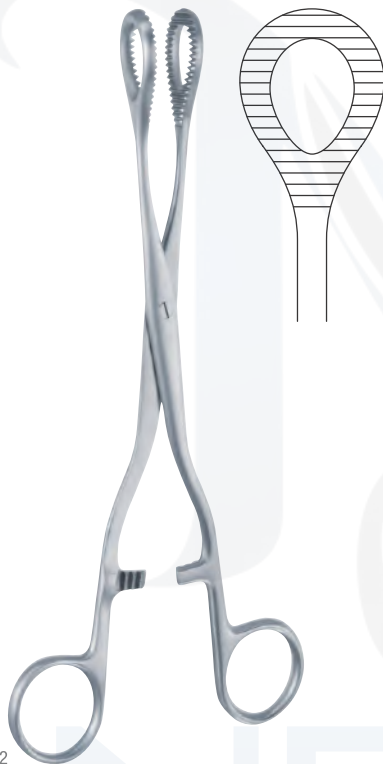

**HEYWOOD-SMITH** 1:2

200 mm – 8"

16-222-210

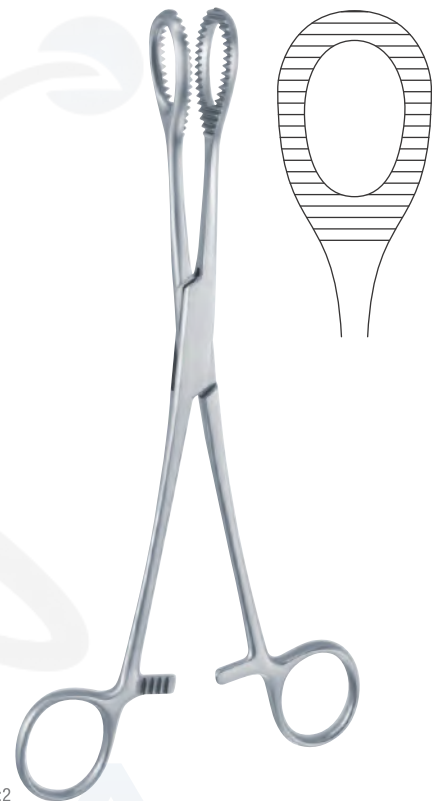

**HEYWOOD-SMITH** 1:2

210 mm – 8¼"

16-223-210

**hämorrhoidal-ligatoren**  
**Haemorrhoidal ligators**

**Ligateurs hémorroïdales**  
**Ligadores hemorroidales**  
**Legatori emorroidali**



**RUDD**

1:2

	x = 12 mm Ø	x = 12 mm Ø
315 mm – 12 ½ "	16-227-000	16-227-020

komplett  
complete  
complét  
completa  
completa

Ladekegel allein  
Cone piece only  
Cône seule  
Cono sólo  
Cono solo

**16-226-000**

Gummiringe, Packung à 100 Stück  
Rubber rings, package of 100 pieces  
Anneaux de caoutchouc à ligatures, paquet de 100 pièces  
Anillos de goma para ligaduras, paquete de 100 piezas  
Anelli di gomma, pacchetto di 100 pezzi

**hämmorrhoidal-ligatoren**  
**Haemorrhoidal ligators**

*Ligateurs hémorroïdales*  
*Ligadores hemorroidales*  
*Legatori emorroidali*



**LURZ**

x = 8 mm Ø	16-224-008
x = 10 mm Ø	16-224-010

komplett  
complete  
complét  
completa  
completa

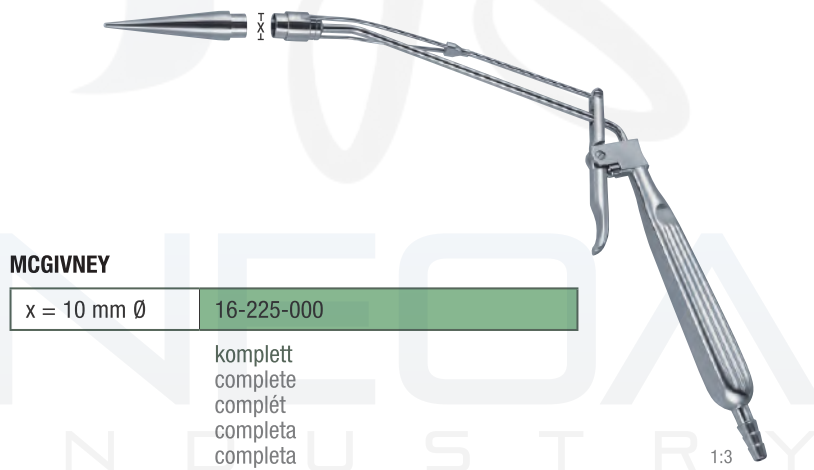

**MCGIVNEY**

x = 10 mm Ø	16-225-000
-------------	------------

komplett  
complete  
complét  
completa  
completa

**16-226-000**

Gummiringe, Packung à 100 Stück  
Rubber rings, package of 100 pieces  
Anneaux de caoutchouc à ligatures, paquet de 100 pièces  
Anillos de goma para ligaduras, paquete de 100 piezas  
Anelli di gomma, pacchetto di 100 pezzi





Manufacturer & Supplier Premium Quality Surgical, Dental, Podiatry, Pet Grooming and Beauty Care Instruments.

**USA Address:**

📍 5900 Balcones Drive # 16244  
Austin TX, USA 78731.  
☎ +1 (917) 773 3694  
📞 **uk:** +44 7871 836765  
✉ info@neoindustry.com  
neoaindustry4@gmail.com  
🌐 www.neoindustry.com

**Main Head Office:**

📍 Roars Road New Miana Pura  
West, Sialkot 51310 Pakistan.  
☎ +92 322 5587688  
📞 +92 322 5587688  
✉ info@neoindustry.com  
neoaindustry4@gmail.com  
🌐 www.neoindustry.com

