

» Scheren

» Scissors

» Ciseaux

» Tijeras

» Forbici



Chirurgische Scheren Operating scissors

Ciseaux à chirurgie
Tijeras para cirugía
Forbici per chirurgia

TC



		TC		Supercut	TC		TC
	Fig. 1	Fig. 1	Fig. 2	Fig. 2	Fig. 2	Fig. 3	Fig. 3
105 mm – 4 ¼ "	02-191-105		02-192-105			02-193-105	
115 mm – 4 ½ "	02-191-115		02-192-115			02-193-115	
130 mm – 5 "	02-191-130		02-192-130	02-451-130		02-193-130	
145 mm – 5 ¾ "	02-191-145	02-405-145	02-192-145	02-451-140	02-407-145	02-193-145	02-406-145
155 mm – 6 "	02-191-155		02-192-155			02-193-155	
165 mm – 6 ½ "	02-191-165	02-450-160	02-192-165		02-452-160	02-193-165	02-453-160
175 mm – 7 "	02-191-175		02-192-175			02-193-175	
185 mm – 7 ¼ "	02-191-185	02-450-180	02-192-185		02-452-180	02-193-185	02-453-180
200 mm – 8 "	02-191-200		02-192-200			02-193-200	



		TC		Supercut	TC		TC
	Fig. 1	Fig. 1	Fig. 2	Fig. 2	Fig. 2	Fig. 3	Fig. 3
105 mm – 4 ¼ "	02-194-105		02-196-105			02-198-105	
115 mm – 4 ½ "	02-194-115		02-196-115			02-198-115	
130 mm – 5 "	02-194-130		02-196-130	02-454-130		02-198-130	
145 mm – 5 ¾ "	02-194-145	02-408-145	02-196-145	02-454-140	02-409-145	02-198-145	02-410-145
155 mm – 6 "	02-194-155		02-196-155			02-198-155	
165 mm – 6 ½ "	02-194-165	02-455-160	02-196-165		02-456-160	02-198-165	02-457-160
175 mm – 7 "	02-194-175		02-196-175			02-198-175	
185 mm – 7 ¼ "	02-194-185	02-455-180	02-196-185		02-456-180	02-198-185	02-457-180
200 mm – 8 "	02-194-200		02-196-105			02-198-105	

**Chirurgische Scheren
Operating scissors**

*Ciseaux à chirurgie
Tijeras para cirugía
Forbici per chirurgia*



GRAZIL

	Fig. 1	Fig. 2	Fig. 3
130 mm – 5 "	02-458-130	02-459-130	02-460-130
145 mm – 5 ¾ "	02-458-140	02-459-140	02-460-140



GRAZIL

	Fig. 1	Fig. 2	Fig. 3
130 mm – 5 "	02-461-130	02-462-130	02-463-130
140 mm – 5 ½ "	02-461-140	02-462-140	02-463-140



Chirurgische Scheren Operating scissors

*Ciseaux à chirurgie
Tijeras para cirugía
Forbici per chirurgia*

TC



1:2

DEAVER

140 mm – 5½"	02-200-140	02-201-140	02-200-140S	02-201-140S
gerade straight droits recta rette		gebogen curved courbes curva curve	gerade, gezahnt straight, saw edge droits, dentelés recta, dentada rette, dentate	gebogen, gezahnt curved, saw edge courbes, dentelés curva, dentada curve, dentate

DEAVER

	TC	TC
140 mm – 5½"	02-464-140	02-465-140
gerade straight droits recta rette		gebogen curved courbes curva curve



1:2



1:2



1:2



1:2



1:2

LANGE

145 mm – 5¾"	02-204-145	02-205-145	02-204-145S	02-205-145S
gerade straight droits recta rette		gebogen curved courbes curva curve	gerade, gezahnt straight, saw edge droits, dentelés recta, dentada rette, dentate	gebogen, gezahnt curved, saw edge courbes, dentelés curva, dentada curve, dentate



1:2



1:2



1:2



1:2

Chirurgische Scheren Operating scissors

Ciseaux à chirurgie
Tijeras para cirugía
Forbici per chirurgia

TC



1:2

MIXTER



1:2



1:2

155 mm – 6 "	02-206-155	02-206-155S	02-207-155	02-207-155S
	gerade straight droits recta rette	gerade, gezahnt straight, saw edge droits, dentelés recta, dentada rette, dentate	gebogen curved courbes curva curve	gebogen, gezahnt curved, saw edge courbes, dentelés curva, dentada curve, dentate



LEXER

		Supercut	TC	TC/Supercut	Ceramic Cut
160 mm – 6 ¼ "	02-466-160	02-467-160	02-468-160	02-469-160	02-468-160K
210 mm – 8 ¼ "	02-466-210		02-468-210		



LEXER



		Supercut	TC	TC/Supercut	Ceramic Cut
160 mm – 6 ¼ "	02-470-160	02-471-160	02-472-160	02-473-160	02-472-160K
210 mm – 8 ¼ "	02-470-210		02-472-210		

Chirurgische Scheren
Operating scissors

Ciseaux à chirurgie
Tijeras para cirugía
Forbici per chirurgia



RICHTER

1:2

145 mm – 5 ¾"	02-211-145
---------------	------------



FERGUSSON

140 mm – 5 ½"	02-209-140
160 mm – 6 ¼"	02-209-160
180 mm – 7"	02-209-180



130 mm – 5"	02-210-130
145 mm – 5 ¾"	02-210-145

NEOA
INDUSTRY

Chirurgische Scheren – Präparierscheren
Operating scissors – Dissecting scissors

Ciseaux à chirurgie – Ciseaux à dissection
Tijeras para cirugía – Tijeras de disección
Forbici per chirurgia – Forbici per dissezione

TC



MAYO

		Supercut	TC	TC / Supercut	Ceramic Cut
145 mm – 5 ¾"	02-212-145	02-474-140	02-411-140		02-212-145K
150 mm – 6"	02-212-150	02-478-150			
170 mm – 6 ¾"	02-212-170	02-474-170	02-411-170	02-475-170	02-212-170K
230 mm – 9"	02-212-230		02-411-230		02-212-230K

NEOA
INDUSTRY



MAYO

		Supercut	TC	TC / Supercut	Ceramic Cut
145 mm – 5 ¾"	02-213-145	02-476-140	02-412-140		02-213-145K
150 mm – 6"	02-213-150	02-477-150			
170 mm – 6 ¾"	02-213-170	02-476-170	02-412-170	02-479-170	02-213-170K
200 mm – 8"			02-412-200		
230 mm – 9"	02-213-230		02-412-230		02-213-230K

Chirurgische Scheren – Präparierscheren
 Operating scissors – Dissecting scissors
 Ciseaux à chirurgie – Ciseaux à dissection
 Tijeras para cirugía – Tijeras de disección
 Forbici per chirurgia – Forbici per dissezione

TC



MAYO-STILLE

		Supercut	TC	TC / Supercut	Ceramic Cut
150 mm – 6 "	02-214-150	02-478-150	02-480-150		02-214-150K
170 mm – 6 ¾ "	02-214-170	02-478-170	02-480-170	02-482-170	02-214-170K
190 mm – 7 ½ "	02-214-190				
210 mm – 8 ¾ "	02-481-210				



MAYO-STILLE

		Supercut	TC	TC / Supercut	Ceramic Cut
150 mm – 6 "	02-215-150	02-477-150	02-413-150		02-215-150K
170 mm – 6 ¾ "	02-215-170	02-477-170	02-413-170	02-483-170	02-215-170K
190 mm – 7 ½ "	02-215-190				
210 mm – 8 ¾ "	02-483-210				

Chirurgische Scheren – Präparierscheren
Operating scissors – Dissecting scissors

Ciseaux à chirurgie – Ciseaux à dissection
Tijeras para cirugía – Tijeras de disección
Forbici per chirurgia – Forbici per dissezione

TC

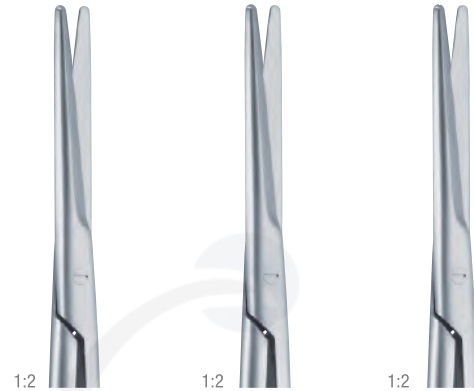

MAYO-HARRINGTON

		Supercut	TC
230 mm – 9"	02-484-230	02-474-230	02-485-230



MAYO-HARRINGTON

		Supercut	TC
230 mm – 9"	02-486-230	02-476-230	02-487-230



MAYO-NOBLE

170 mm – 6 3/4"	02-488-170	02-489-170
-----------------	------------	------------

Chirurgische Scheren – Präparierscheren
Operating scissors – Dissecting scissors

Ciseaux à chirurgie – Ciseaux à dissection
Tijeras para cirugía – Tijeras de disección
Forbici per chirurgia – Forbici per dissezione

TC



WERTHEIM

		TC
145 mm – 5 ¾ "	02-490-140	
195 mm – 7 ⅔ "	02-491-195	
225 mm – 8 ¾ "	02-491-220	308-523-220



1:2



1:2



1:2

METZENBAUM

		Supercut	TC / Supercut
150 mm – 6 "	02-216-150	02-492-150	02-493-150

gerade
straight
droits
recta
rette



1:2



1:2



1:2



1:2

METZENBAUM

		Supercut	TC / Supercut	Ceramic Cut
150 mm – 6 "	02-217-150	02-454-150	02-495-150	02-217-150K

gebogen
curved
courbes
curva
curve



1:2

Chirurgische Scheren – Präparierscheren
Operating scissors – Dissecting scissors

Ciseaux à chirurgie – Ciseaux à dissection

Tijeras para cirugía – Tijeras de disección

Forbici per chirurgia – Forbici per dissezione

TC



METZENBAUM

		Supercut	TC	Ceramic Cut
	Fig. 1	Fig. 1	Fig. 1	Fig. 1
115 mm – 4 ½"	02-496-110	02-492-110	02-497-110	02-496-110K
145 mm – 5 ¾"	02-216-145	02-216-145SC	02-498-145	02-216-145K



METZENBAUM

		TC		TC
	Fig. 2	Fig. 2	Fig. 3	Fig. 3
145 mm – 5 ¾"	02-499-140	02-414-145	411-250-140	02-415-145

Chirurgische Scheren – Präparierscheren
Operating scissors – Dissecting scissors

Ciseaux à chirurgie – Ciseaux à dissection

Tijeras para cirugía – Tijeras de disección

Forbici per chirurgia – Forbici per dissezione

TC



METZENBAUM

		Supercut	TC	Ceramic Cut
	Fig. 1	Fig. 1	Fig. 1	Fig. 1
115 mm – 4 ½ "	02-451-110	02-454-110	02-452-110	02-451-110K
145 mm – 5 ¾ "	02-217-145	02-217-145SC	02-453-145	02-217-145K



METZENBAUM

		TC		TC
	Fig. 2	Fig. 2	Fig. 3	Fig. 3
145 mm – 5 ¾ "	02-456-140	02-416-145	02-457-140	02-417-145

Chirurgische Scheren – Präparierscheren Operating scissors – Dissecting scissors

Ciseaux à chirurgie – Ciseaux à dissection
Tijeras para cirugía – Tijeras de disección
Forbici per chirurgia – Forbici per dissezione

TC



METZENBAUM- NELSON

		Supercut	TC	TC / Supercut	Ceramic Cut
	Fig. 1	Fig. 1	Fig. 1	Fig. 1	Fig. 1
180 mm – 7 "	02-218-180	02-492-180	02-418-180	02-493-180	02-218-180K
200 mm – 8 "	02-218-200	02-492-200	02-418-200	02-493-200	02-218-200K
230 mm – 9 "	02-218-230	02-492-230	02-418-230	02-493-230	02-218-230K
250 mm – 9 ¼ "	02-218-250	02-492-250	308-280-250		
280 mm – 11 "	02-218-280		308-280-280		
300 mm – 12 "	02-218-300		308-280-300		



METZENBAUM- NELSON



		TC		TC
	Fig. 2	Fig. 2	Fig. 3	Fig. 3
180 mm – 7 "	02-458-180	02-414-180	02-460-180	02-415-180
200 mm – 8 "	02-458-200	02-414-200	02-460-200	02-415-200
230 mm – 9 "	02-458-230	02-414-230	02-460-230	02-415-230
250 mm – 9 ¼ "	02-458-250		02-460-250	
280 mm – 11 "	02-458-280		02-460-280	
300 mm – 12 "	02-458-300		02-460-300	

Chirurgische Scheren – Präparierscheren
Operating scissors – Dissecting scissors

Ciseaux à chirurgie – Ciseaux à dissection
Tijeras para cirugía – Tijeras de disección
Forbici per chirurgia – Forbici per dissezione

TC



**METZENBAUM-
NELSON**

		Supercut	TC	TC / Supercut	Ceramic Cut
	Fig. 1	Fig. 1	Fig. 1	Fig. 1	Fig. 1
180 mm – 7 "	02-219-180	02-454-180	02-419-180	02-495-180	02-219-180K
200 mm – 8 "	02-219-200	02-454-200	02-419-200	02-495-200	02-219-200K
230 mm – 9 "	02-219-230	02-454-230	02-419-230	02-495-230	02-219-230K
250 mm – 9 ¾ "	02-219-250	02-454-250	02-461-250		02-219-250K
280 mm – 11 "	02-219-280		02-461-280		
300 mm – 12 "	02-219-300		02-461-300		02-219-300K

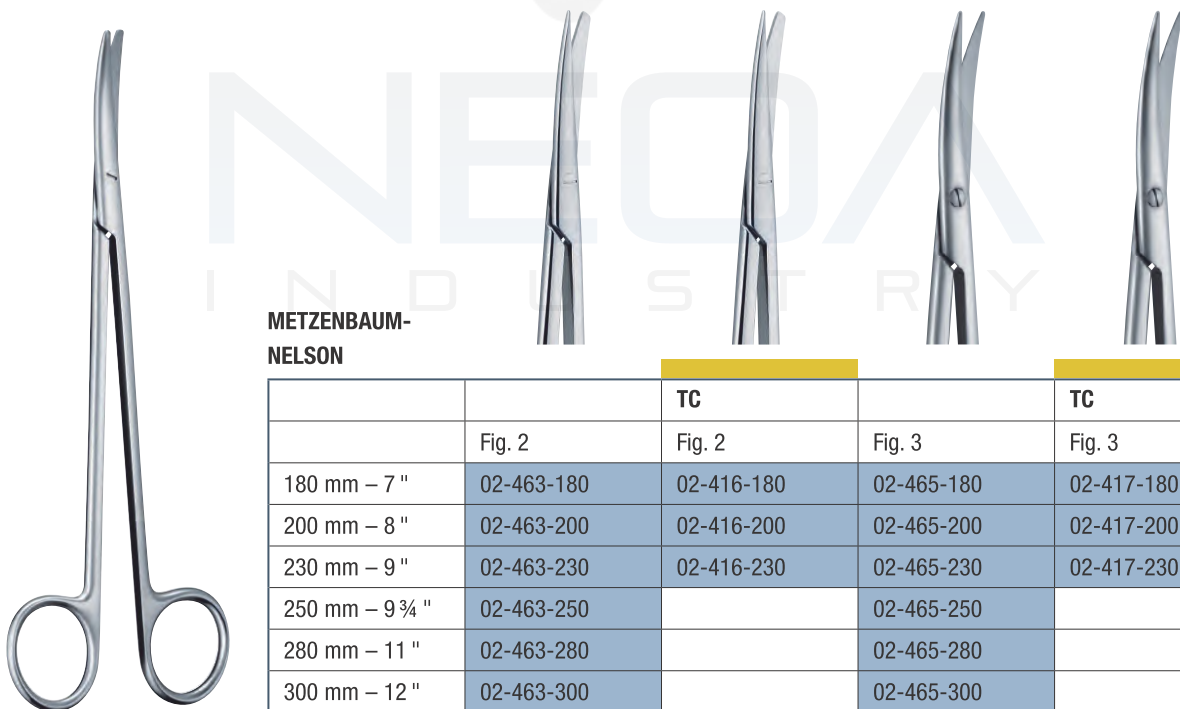

**METZENBAUM-
NELSON**

		TC		TC
	Fig. 2	Fig. 2	Fig. 3	Fig. 3
180 mm – 7 "	02-463-180	02-416-180	02-465-180	02-417-180
200 mm – 8 "	02-463-200	02-416-200	02-465-200	02-417-200
230 mm – 9 "	02-463-230	02-416-230	02-465-230	02-417-230
250 mm – 9 ¾ "	02-463-250		02-465-250	
280 mm – 11 "	02-463-280		02-465-280	
300 mm – 12 "	02-463-300		02-465-300	

Chirurgische Scheren – Präparierscheren
Operating scissors – Dissecting scissors

Ciseaux à chirurgie – Ciseaux à dissection

Tijeras para cirugía – Tijeras de disección

Forbici per chirurgia – Forbici per dissezione

TC

**METZENBAUM-
FINO**

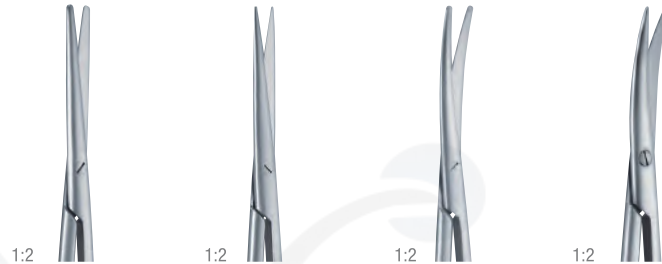

	Fig. 1	Fig. 3	Fig. 1	Fig. 3
145 mm – 5 ¾ "	02-220-145	411-324-140	02-221-145	02-467-140

	Ceramic Cut	Ceramic Cut	Ceramic Cut	Ceramic Cut
	Fig. 1	Fig. 3	Fig. 1	Fig. 3
145 mm – 5 ¾ "	02-220-145K		02-221-145K	02-467-140K



1:2

**METZENBAUM-
FINO**

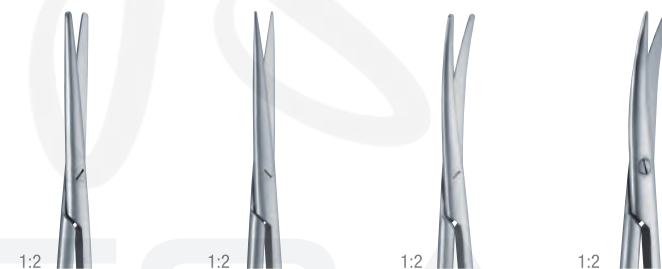

	TC	TC	TC	TC
	Fig. 1	Fig. 3	Fig. 1	Fig. 3
145 mm – 5 ¾ "	02-420-145	411-952-140	02-421-145	02-468-140

**METZENBAUM-
FINO**



	Supercut	Supercut
	Fig. 1	Fig. 1
145 mm – 5 ¾ "	02-224-145	02-225-145

Chirurgische Scheren – Präparierscheren Operating scissors – Dissecting scissors

Ciseaux à chirurgie – Ciseaux à dissection
Tijeras para cirugía – Tijeras de disección
Forbici per chirurgia – Forbici per dissezione

TC



METZENBAUM-FINO

		Supercut	TC
180 mm – 7 "	02-469-180	02-470-180	02-472-180
200 mm – 7 ¾ "	02-469-200	02-470-200	02-472-200
230 mm – 9 "	02-469-230	02-470-230	02-472-230
250 mm – 10 "			02-472-250
280 mm – 11 "			02-472-280



METZENBAUM-FINO

		TC
180 mm – 7 "	02-473-180	02-475-180
220 mm – 8 "	02-474-200	02-476-200
230 mm – 9 "	02-474-230	02-476-230

S-förmig gebogen
S-curved
courbes en S
curva en S
curve a forma di S

S-förmig gebogen
S-curved
courbes en S
curva en S
curve a forma di S



METZENBAUM-FINO

		Supercut	TC	TC / Supercut	Ceramic Cut
180 mm – 7 "	02-478-180	02-479-180	02-480-180	02-481-180	02-480-180K
200 mm – 7 ¾ "	02-478-200	02-479-200	02-480-200		02-480-200K
230 mm – 9 "	02-478-230	02-479-230	02-480-230		02-480-230K
250 mm – 10 "			02-480-250		
260 mm – 10 ¼ "					02-480-260K
280 mm – 11 "			02-480-280		
300 mm – 12 "					02-480-300K

Chirurgische Scheren – Präparierscheren
Operating scissors – Dissecting scissors

Ciseaux à chirurgie – Ciseaux à dissection

Tijeras para cirugía – Tijeras de disección

Forbici per chirurgia – Forbici per dissezione

TC

**GOLDMANN-
FOX**

1:2



1:2



1:2



1:2



			Supercut	TC
130 mm – 5"	02-230-130	02-231-130	02-232-130	02-482-130

gezahnt
saw edge
denteles
dentada
dentata

gerade
straight
droits
recta
rette



1:2

**GOLDMANN-
FOX**

1:2



1:2



1:2



1:2



			Supercut	TC
130 mm – 5"	02-233-130	02-234-130	02-235-130	02-483-130

gezahnt
saw edge
denteles
dentada
dentata

gebogen
curved
courbes
curva
curve

Präparierscheren
Dissecting scissors
Ciseaux à dissection
Tijeras de disección
Forbici per dissezione



FOMON

1:2

140 mm – 5 ½ "

02-484-140



THOREK

185 mm – 7 ⅓ "

02-485-180

250 mm – 9 ¾ "

02-485-250

Gynäkologische Scheren Gynecological scissors

*Ciseaux à gynécologie
Tijeras para ginecología
Forbici per ginecologia*

TC



SIMS

		Supercut	TC	
	Fig. 1	Fig. 1	Fig. 1	Fig. 2
200 mm – 8 "	02-240-200	02-486-200		02-242-200
230 mm – 9 "	02-240-230	02-486-230	02-487-230	02-242-230



SIMS

		Supercut	TC	
	Fig. 1	Fig. 1	Fig. 1	Fig. 2
200 mm – 8 "	02-243-200	02-488-200		02-245-200
230 mm – 9 "	02-243-230	02-488-230	02-490-230	02-245-230

Gynäkologische Scheren Gynecological scissors

Ciseaux à gynécologie
Tijeras para ginecología
Forbici per ginecologia

TC



DUBOIS

270 mm – 10 3/4 "	02-492-270	02-493-270
-------------------	------------	------------



DOYEN

175 mm – 7 "	02-248-175	02-249-175
--------------	------------	------------



SIEBOLD

240 mm – 9 1/2 "	02-494-240	Supercut 02-95-240
------------------	------------	------------------------------



S-förmig gebogen
S-curved
courbes en S
curva en S
curve a forma di S

S-förmig gebogen
S-curved
courbes en S
curva en S
curve a forma di S

Feine chirurgische Scheren Fine operating scissors

Ciseaux fins à chirurgie
Tijeras finas para cirugía
Forbici fine per chirurgia

TC

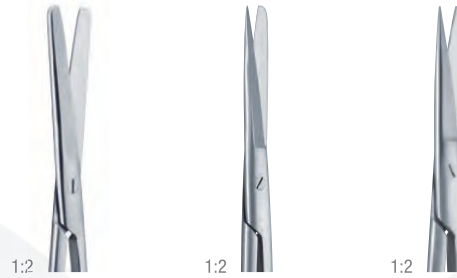
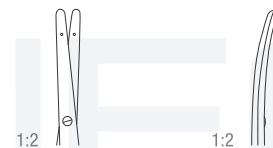

	Fig. 1	Fig. 2	Fig. 3
120 mm – 4 ¾"	02-496-120	02-498-120	02-499-120



	Fig. 1	Fig. 2	Fig. 3
120 mm – 4 ¾"	02-500-120	02-501-120	02-502-120

KNAPP



105 mm – 4 ¼"	02-503-100	02-504-100
---------------	------------	------------

stumpf
blunt
mousses
roma
smusse



KNAPP

		Ceramic Cut		Ceramic Cut
105 mm – 4 ¼"	02-506-100		02-507-100	
120 mm – 4 ¾"		02-508-120K		02-509-120K

spitz
sharp
pointus
aguda
acute



Feine Scheren
Fine scissors

Ciseaux fins
Tijeras finas
Forbici fini

TC



1:2

WAGNER

1:2



1:2



1:2



1:2



		Supercut		Supercut	
120 mm – 4 ¾"	02-510-120	02-511-120	02-513-120	02-512-120	

gerade
straight
droits
recta
rette

gebogen
curved
courbes
curva
curve



1:2

BROPHY
(SULLIVAN)

1:2



1:2



145 mm – 5 ¾"	02-250-145	02-251-145
---------------	------------	------------

LITTLER



115 mm – 4 ½"	02-252-120
145 mm – 5 ¾"	02-252-145

Feine Scheren
Fine scissors

Ciseaux fins
Tijeras finas
Forbici fini

TC



NEUMANN

120 mm – 4 ¾"	02-514-120
---------------	------------

S-förmig gebogen
S-curved
courbes en S
curva en S
curve a forma di S



QUINBY

125 mm – 5"	125 mm – 5"
02-255-125	02-256-125

gerade
straight
droits
recta
rette

gebogen
curved
courbes
curva
curve



LOCKLIN

		TC		TC
165 mm – 6 ½"	02-515-160	02-517-160	02-516-160	02-518-160

gezahnt
saw edge,
dentelées
dentada
dentate

Feine Scheren
Fine scissors

Ciseaux fins
Tijeras finas
Forbici fini

TC



REYNOLDS

		Supercut	TC
150 mm – 6 "	02-519-150	02-520-150	02-521-150
180 mm – 7 "	02-519-180	02-520-180	



REYNOLDS

		Supercut	TC	Ceramic Cut
150 mm – 6 "	02-522-150	02-523-150	02-524-150	02-523-150K
180 mm – 7 "	02-522-180	02-523-180		02-523-180K

Feine Scheren
Fine scissors

Ciseaux fins
Tijeras finas
Forbici fini

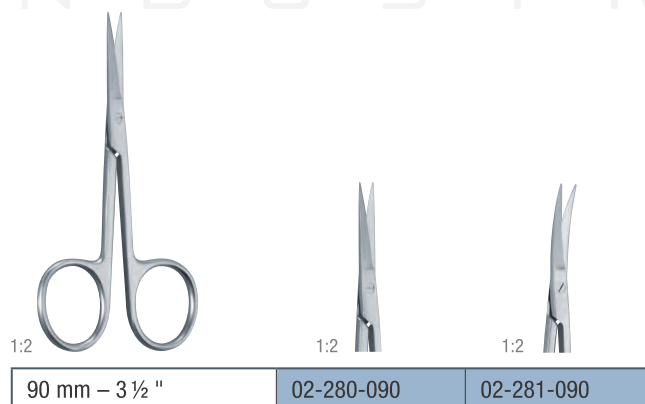
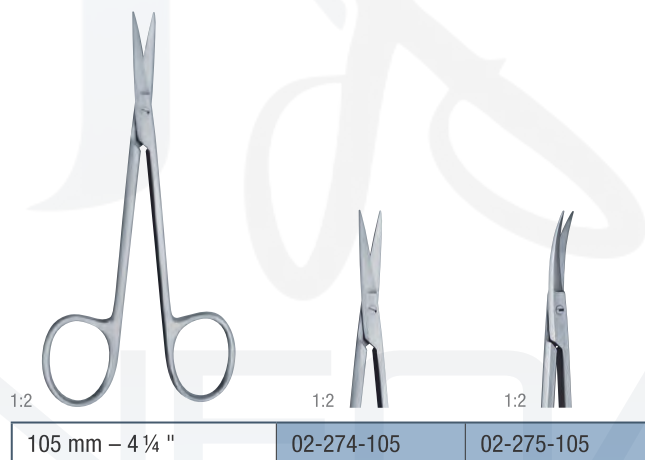

Feine Scheren
Fine scissors
Ciseaux fins
Tijeras finas
Forbici fini

TC



		Supercut	TC	TC / Supercut	Ceramic Cut
90 mm – 3 ½ "	02-290-090	02-525-090			
105 mm – 4 ¼ "	02-290-105			02-526-110	
115 mm – 4 ½ "	02-290-115	02-298-115	02-424-115		02-290-115K
120 mm – 4 ¾ "	02-290-120				



		Supercut	TC	TC / Supercut	Ceramic Cut
90 mm – 3 ½ "	02-301-090	02-527-090			
105 mm – 4 ¼ "	02-301-105			02-528-110	
115 mm – 4 ½ "	02-301-115	02-309-115	02-425-115		02-301-115K
120 mm – 4 ¾ "	02-301-120				



115 mm – 4 ½ "	02-303-115	02-305-115
----------------	------------	------------

seitwärts gebogen
laterally curved
courbes laterale
curva lateral
curvata lateralmente

seitwärts abgewinkelt
laterally angled
angle laterale
angulada lateral
angolo lateralmente

Feine Scheren
Fine scissors

Ciseaux fins
Tijeras finas
Forbici fini

TC

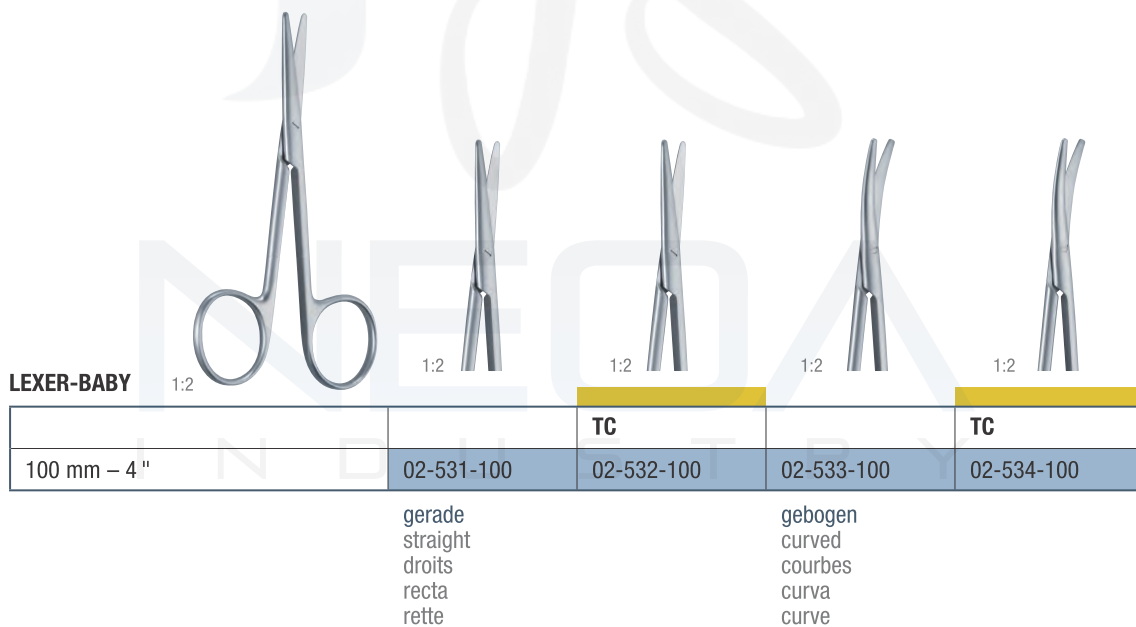

**Fistelscheren
Fistula scissors**

*Ciseaux pour fistules
Tijeras para fistulas
Forbici per fistole*

TC



KELLY

		Supercut	TC	Ceramic Cut
160 mm – 6 ¼ "	02-320-160	02-322-160	02-535-160	
180 mm – 7 "	02-320-180	02-322-180		02-320-180K



KELLY

		Supercut	TC	Ceramic Cut
160 mm – 6 ¼ "	02-323-160	02-324-160	02-536-160	
180 mm – 7 "	02-323-180	02-324-180		02-323-180K

Enukleationsscheren Enucleation scissors

Ciseaux à énucléation
Tijeras para enucleación
Forbici per enucleazione

TC



1:2

LANDOLDT

125 mm – 5 "

1:2



1:2



leicht gebogen
slight curved
facile courbes
ligeramente curva
facile curve

stark gebogen
strong curved
tort courbes
fuerte curva
forte curve



1:2

1:2

1:2

1:2

		Ceramic Cut		Ceramic Cut
115 mm – 4 ½ "	02-328-115	02-328-115K	02-327-115	02-327-115K

gerade
straight
droits
recta
rette

gebogen
curved
courbes
curva
curve



1:2

CHADWICK

110 mm – 4 ¼ "

02-330-110

Scheren für die Plastische Chirurgie
Plastic surgery scissors

Ciseaux pour la chirurgie plastique
Tijeras para cirugía plástica
Forbici per chirurgia plastica

TC

JOSEPH 1:2

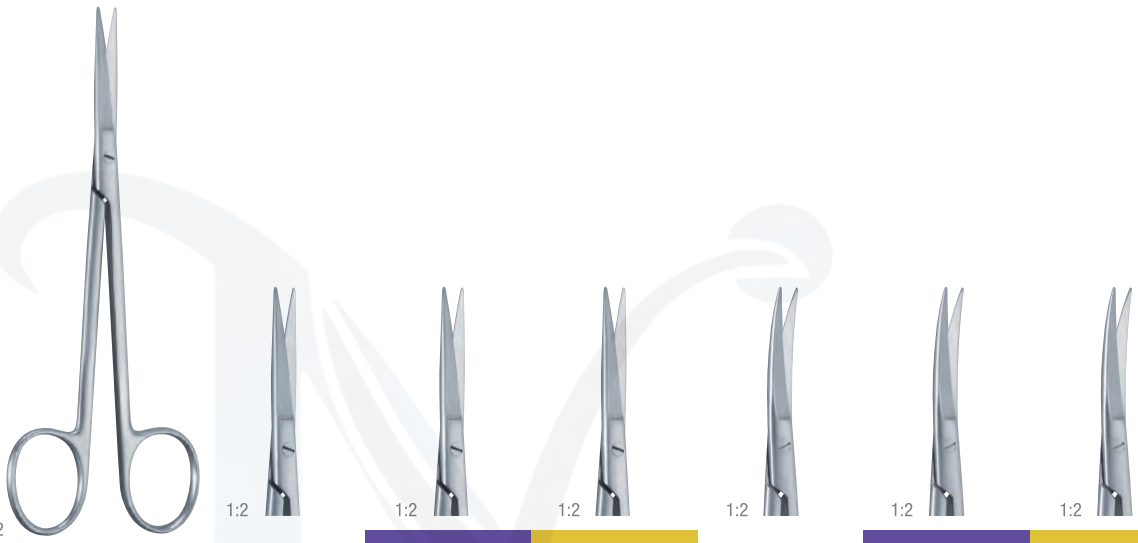

		Supercut	TC		Supercut	TC
140 mm – 5 ½ "	02-335-140	02-332-140	02-426-140	02-336-140	02-338-140	02-427-140

KILNER (RAGNELL)



		TC
120 mm – 4 ¾ "	02-339-125	02-537-120
150 mm – 6 "	02-339-150	02-537-150

Scheren für die Plastische Chirurgie
Plastic surgery scissors

Ciseaux pour la chirurgie plastique
Tijeras para cirugía plástica
Forbici per chirurgia plastica

TC

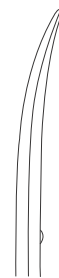
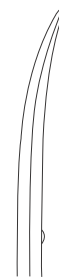
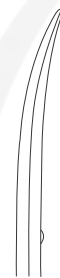

GORNEY

		TC		TC	Ceramic Cut
120 mm – 4 ¾"	02-538-120				
170 mm – 6 ¾"					02-539-170K
190 mm – 7 ½"	02-538-190	02-428-185	02-539-190	02-429-185	02-539-190K
230 mm – 9"					02-539-230K

NEOA
INDUSTRY



1:2

KAYE

	TC
115 mm - 4 ½"	02-430-115

Gefäßscheren
Artery scissors

Ciseaux vasculaires
Tijeras vasculares
Forbici vascolari



1:2

145 mm – 5 ¾"

02-540-150

- 1 Blatt mit Sondenspitze
- 1 Blade with probe
- 1 Lame avec sonde
- 1 Punta forma sonda
- 1 Lama con sonda



LINCOLN

1:2

170 mm – 6 ¾"

1:2

02-346-170

1:2

02-347-170



1:2

115 mm – 4 ½"

02-348-115



FULTON

1:2

170 mm – 6 ¾"

02-349-170



**POTTS-SMITH
(DE MARTEL)**

1:2

195 mm – 7 ¾"

02-351-045

**Gefäßscheren
Artery scissors**

*Ciseaux vasculaires
Tijeras vasculares
Forbici vascolari*

TC

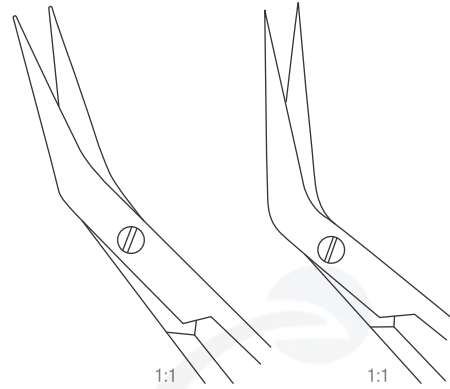

FAVALORO

150 mm – 6"

411-415-900

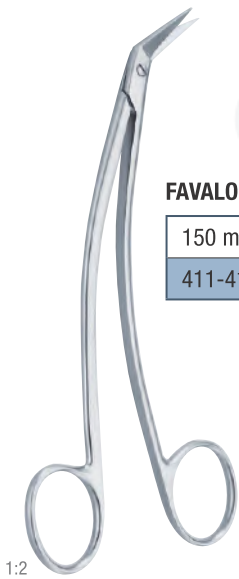

DE BAKEY

155 mm – 6"

02-352-155

02-353-155

Offset-Schere, S-förmig
Offset scissors, s-shaped
Ciseaux offset, courbes en S
Tijera offset, curva en S
Forbici offset, curve a forma di S



MILLS

225 mm – 8 ¾"

02-541-220



25°

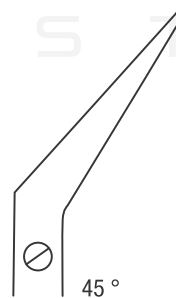

45°

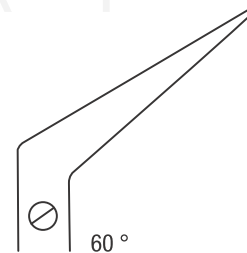

60°

DE BAKEY

		TC		TC		TC
160 mm – 6 ¼"	02-542-160	02-543-250	02-544-160	02-543-450	02-545-160	02-543-600
230 mm – 9"	02-542-230	02-546-250	02-544-230	02-546-450	02-545-230	02-546-600
280 mm – 11"	02-542-280	02-547-250	02-544-280	02-547-450	02-545-280	02-547-600

Gefäßscheren Artery scissors

Ciseaux vasculaires
Tijeras vasculares
Forbici vascolari

TC

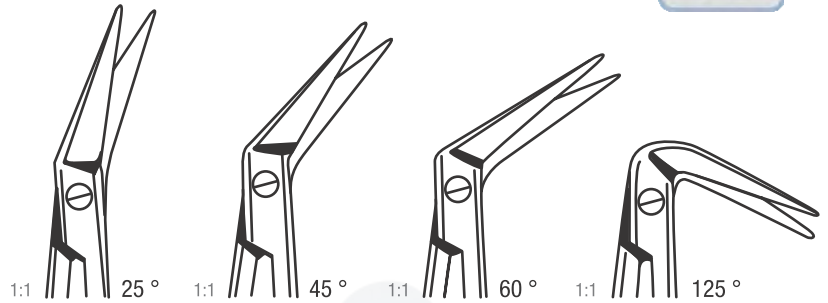
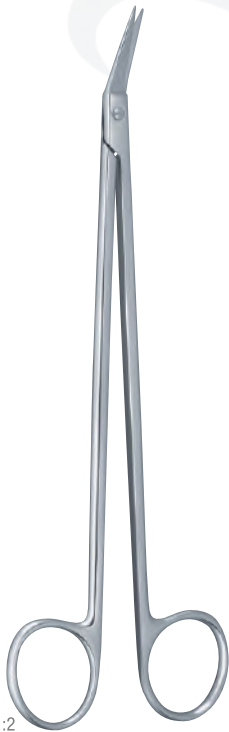

POTTS-SMITH				
190 mm – 7 1/2"	02-354-025	02-354-045	02-354-060	02-354-125

POTTS-SMITH			
	Supercut	Supercut	Supercut
190 mm – 7 1/2"	02-548-250	02-548-450	02-548-600

POTTS-SMITH			
	Ceramic Cut	Ceramic Cut	Ceramic Cut
190 mm – 7 1/2"	02-548-250K	02-548-450K	02-548-600K

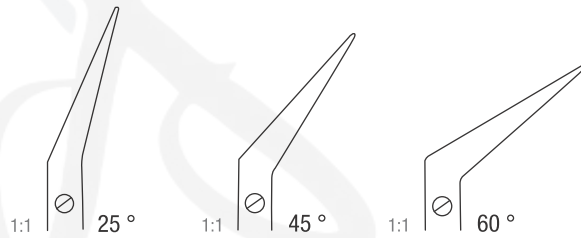

POTTS-SMITH			
	TC	TC	TC
190 mm – 7 1/2"	02-549-250	02-549-400	02-549-600

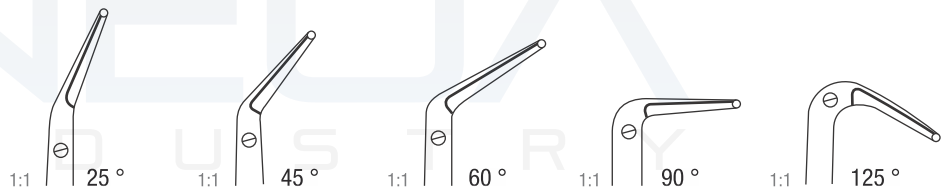

180 mm – 7"	02-550-250	02-550-450	02-550-600	02-550-900	02-551-000
-------------	------------	------------	------------	------------	------------



02-552-250	02-552-450	02-552-600	02-552-900	02-550-000
------------	------------	------------	------------	------------

Ceramic Cut	Ceramic Cut	Ceramic Cut	Ceramic Cut	Ceramic Cut
02-552-250K	02-552-450K	02-552-600K	02-552-900K	02-550-000K

Gefäßscheren
Artery scissors

Ciseaux vasculaires
Tijeras vasculares
Forbici vascolari

TC

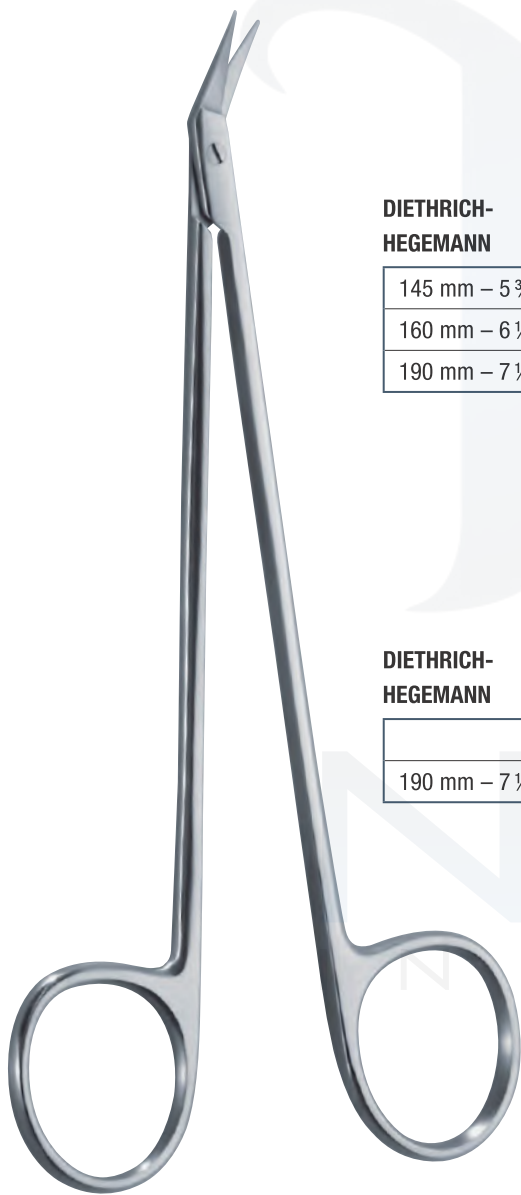

**DIETRICH-
HEGEMANN**

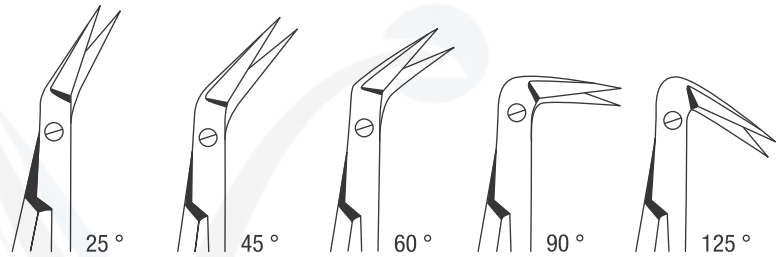

145 mm – 5 ¾ "	02-355-025	02-355-045	02-355-060	02-355-090	02-355-125
160 mm – 6 ¼ "	02-356-025	02-356-045	02-356-060	02-356-090	02-356-125
190 mm – 7 ½ "	02-357-025	02-357-045	02-357-060	02-357-090	02-357-125

**DIETRICH-
HEGEMANN**

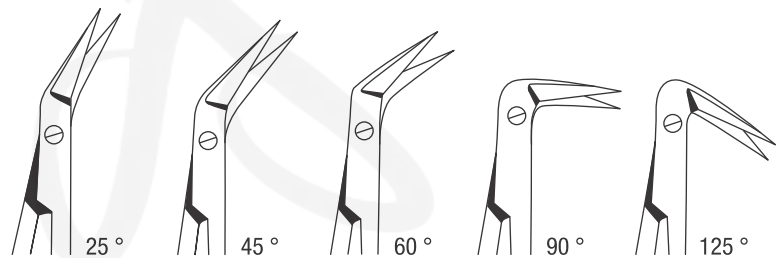

	Ceramic Cut	Ceramic Cut	Ceramic Cut	Ceramic Cut	Ceramic Cut
190 mm – 7 ½ "	02-357-025K	02-357-045K	02-357-060K	02-357-090K	02-357-125K

**Knorpelscheren
Cartilage scissors**

*Ciseaux pour cartilages
Tijeras para cartílagos
Forbici per cartilagini*



1:2

MARTIN-CARTILAGE

200 mm – 8"

02-553-200

gebogen, gezahnt
curved, saw edge
courbes, dentelés
curva, dentada
curve, dentate



1:2

MCINDOE

190 mm – 7½"

02-554-190



1:22

POTTS-SMITH

190 mm – 7½"

02-555-190



Tonsillenscheren Tonsil scissors

Ciseaux pour amygdales
Tijeras para amígdalas
Forbici per tonsille

TC



TOENNIS 1:2
180 mm – 7"



1:2
02-358-180



1:2
02-359-180



PRINCE 1:2
175 mm – 7"



BOETTCHER 1:2
180 mm – 7" 02-360-180



TOENNIS-ADSON 1:2
170 mm – 6 3/4" 02-361-175



1:2
TC 02-557-170



1:2
Ceramic Cut 02-361-175K

Tonsillenscheren Tonsil scissors

Ciseaux pour amygdales
Tijeras para amígdalas
Forbici per tonsille

TC



DEAN

			TC
170 cm – 6 ¾ "	02-362-170	02-363-170	02-558-170

gebogen
curved
courbes
curva
curve

gebogen, gezahnt
curved, saw edge
courbes, dentelés
curva, dentada
curve, dentate

gebogen, gezahnt
curved, saw edge
courbes, dentelés
curva, dentada
curve, dentate

WERTHEIM

140 mm – 5 ¼ "	02-490-140
190 mm – 7 ½ "	02-490-190

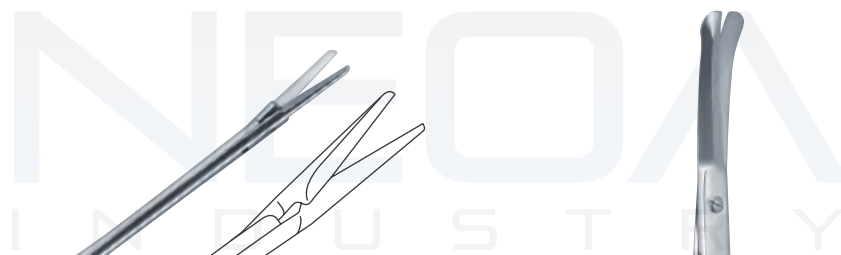

1:1

OLIVECRONA

230 mm – 9 "	02-364-230
--------------	------------

Trigeminusschere
Trigeminal scissors
Ciseaux pour le trigéminus
Tijera para nervio trigémino
Forbici per il nervo trigemino

GOOD

190 mm – 7 ½ "	02-365-190
----------------	------------

1:2



1:2

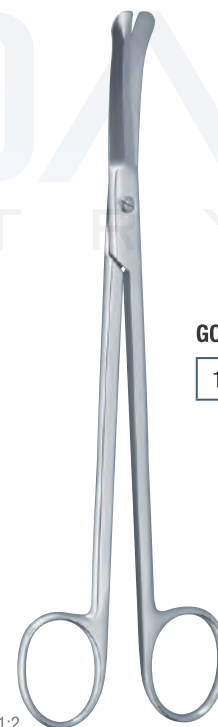

Lungenscheren *Lobectomy scissors*

Ciseaux à lobectomie
Tijeras para lobectomía
Forbici per lobectomia



CRAFOORD 1:3

300 mm – 12"	02-559-300
--------------	------------



WILLAUER

250 mm – 9¾"	02-560-250	02-561-250
280 mm – 11"	02-560-280	02-561-280

gerade	gebogen
straight	curved
droits	courbes
recta	curva
rette	curve



FINOCHIETTO 1:3

270 mm – 10¾"	02-562-270
---------------	------------



RESANO 1:3

250 mm – 10"	02-563-250
--------------	------------

**Thoraxscheren
Thorax scissors**

*Ciseaux pour le thorax
Tijeras para tórax
Forbici per torace*



1:2
SATINSKY

245 mm – 9¾" 02-564-240



1:2
KLINKENBERGH-LOTH

230 mm – 9" 02-565-230



1:2
JORGENSON

220 mm – 8¾" 02-566-220

Darmscheren
Enterotomy scissors
Ciseaux pour l'intestin
Tijeras para intestino
Forbici per enterotomia



1:2

1:2

1:2

	Fig. 1	Fig. 2	Fig. 3
210 mm – 8 ¼ "	02-567-210	02-568-210	02-569-210

Nabelschnurscheren *Umbilical scissors*

Ciseaux pour le cordon ombilical
Tijeras umbilicales
Forbici ombelicali



BUSCH

135 mm – 5 1/3 "	02-367-135
160 mm – 6 1/4 "	02-367-160



1:2

SCHUMACHER

160 mm – 6 1/4 "	02-570-160
------------------	------------



1:2

MOD. USA

105 mm – 4 1/4 "	02-366-105
------------------	------------

Episiotomiescheren
Episiotomy scissors

Ciseaux à épisiotomie
Tijeras para episiotomía
Forbici per episiotomia



BRAUN-STADLER

145 mm – 5¾"	02-368-145
220 mm – 8¾"	02-369-220



1:2?

WALDMANN

180 mm – 7"	02-571-180
-------------	------------

INDUSTRY

Parametriumscheren
Parametrium scissors
Parametrium ciseaux
Paramétrium tijeras
Forbici per il parametrio

TC

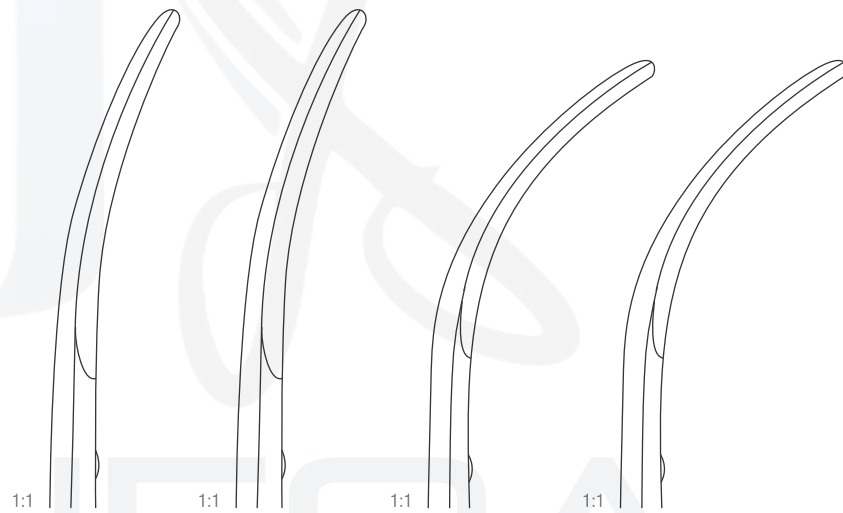

	TC		TC
230 mm – 9"	230 mm – 9"	225 mm – 8¾"	225 mm – 8¾"
02-573-230	02-572-230	02-573-220	02-572-220

Nasenscheren Nasal scissors

Ciseaux nasaux
Tijeras nasales
Forbici nasali

TC



SEILER

1:2

170 mm – 6¾"	02-574-170
--------------	------------



1:2



1:2



1:2

COTTLE

		Supercut	Ceramic Cut
160 mm – 6¼"	02-370-160	02-575-160	02-370-160K



1:2



1:2



1:2

FOMON

		Supercut	Ceramic Cut
130 mm – 5"	02-576-150	02-577-150	02-576-130K



1:2

HEYMANN

		Supercut
180 mm – 7"	02-371-180	02-578-180

Mikroscheren
Micro scissors
Micro-ciseaux
Micro-tijeras
Micro-forbici



NOYES



	Fig. 1	Fig. 2	Fig. 3
120 mm – 4 ¾ "	02-431-120	02-580-120	02-581-120

gerade
straight
droits
recta
rette

spitz – spitz
sharp – sharp
pointue – pointue
roma – roma
acuta – acuta

spitz – stumpf
sharp – blunt
pointue – mousse
roma – aguda
acuta – smussa

stumpf – stumpf
blunt – blunt
mousse – mousse
aguda – aguda
smussa – smussa

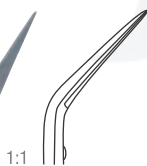

NOYES



	Fig. 1	Fig. 2	Fig. 3
120 mm – 4 ¾ "	02-432-120	02-582-120	02-583-120

abgewinkelt
angulated
coudé
angulado
angolate

spitz – spitz
sharp – sharp
pointue – pointue
roma – roma
acuta – acuta

spitz – stumpf
sharp – blunt
pointue – mousse
roma – aguda
acuta – smussa

stumpf – stumpf
blunt – blunt
mousse – mousse
aguda – aguda
smussa – smussa

Mikroscheren
Micro scissors
Micro-ciseaux
Micro-tijeras
Micro-forbici



1:1

120 mm – 4 ¾" 02-584-120



1:1

BARRAQUER

	55 mm – 2 ¼"
x = 5 mm	02-433-005
x = 7 mm	02-433-007
x = 10 mm	02-433-010



WECKER

1:1

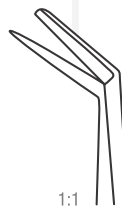

1:1

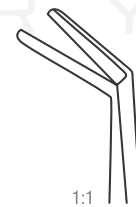

1:1

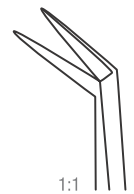

1:1

	Fig. 1	Fig. 2	Fig. 3
110 mm – 4 ¼"	02-434-110	02-435-110	02-436-110

spitz – stumpf
sharp – blunt
pointue – mousse
roma – aguda
acuta – smussa

stumpf – stumpf
blunt – blunt
mousse – mousse
aguda – aguda
smussa – smussa

spitz – spitz
sharp – sharp
pointue – pointue
roma – roma
acuta – acuta

Mikroscheren
Micro scissors
Micro-ciseaux
Micro-tijeras
Micro-forbici



WESTCOTT

1:1

115 mm – 4 ½ "



1:1

02-585-110



1:1

02-586-110



CASTROVIEJO

1:1

90 mm – 3 ½ "

02-587-090

Mikroscheren
Micro scissors
Micro-ciseaux
Micro-tijeras
Micro-forbici



VANNAS	1:1	1:1	1:1
85 mm – 3 1/3 "		02-437-085	02-438-085

CASTROVIEJO	1:1	1:1	1:1
100 mm – 4 "		02-439-100	02-440-100

spitz – spitz	stumpf – stumpf
sharp – sharp	blunt – blunt
pointue – pointue	mousse – mousse
roma – roma	aguda – aguda
acuta – acuta	smussa – smussa

Sehnenscheren
Tenotomy scissors

Ciseaux à ténatomie
Tijeras para tenotomía
Forbici per tenotomia

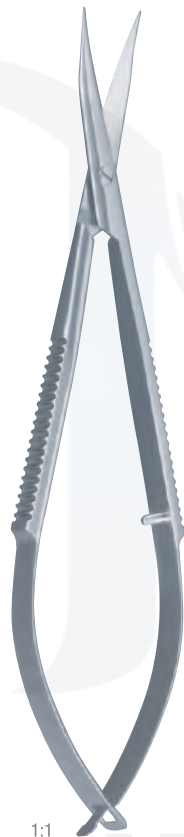

1:1



1:1



1:1

WESTCOTT

110 mm – 4 ¼ "	02-441-110	02-442-110
----------------	------------	------------

spitz – spitz
sharp – sharp
pointue – pointue
roma – roma
acuta – acuta

stumpf – stumpf
blunt – blunt
mousse – mousse
aguda – aguda
smussa – smussa

Irisscheren *Iris scissors*

Ciseaux à iridectomie
Tijeras para iridectomía
Forbici per iridectomia

TC



120 mm – 4 ¾"

1:2



02-290-120

1:2



02-301-120



115 mm – 4 ½"

1:1



Supercut
02-298-115

gerade
straight
droits
recta
rette

1:1



Supercut
02-309-115

gebogen
curved
courbes
curva
curve

**Irisscheren
Iris scissors**

*Ciseaux à iridectomie
Tijeras para iridectomía
Forbici per iridectomia*

TC



		TC	Ceramic Cut		TC	Ceramic Cut
115 mm – 4 ½ "	02-290-115	02-424-115	02-290-115K	02-301-115	02-425-115	02-301-115K
	gerade straight droits recta rette	gerade straight droits recta rette	gerade straight droits recta rette	gebogen curved courbes curva curve	gebogen curved courbes curva curve	gebogen curved courbes curva curve



		TC	
115 mm – 4 ½ "	02-305-115	02-588-110	02-303-115
	kniegebogen angular coudés acodada angolata	kniegebogen angular coudés acodada angolata	seitwärts gebogen laterally curved courbes laterale curva lateral curvata lateralmente

**Sehnenscheren
Tenotomy scissors**

*Ciseaux à ténatomie
Tijeras para tenotomía
Forbici per tenotomia*

TC

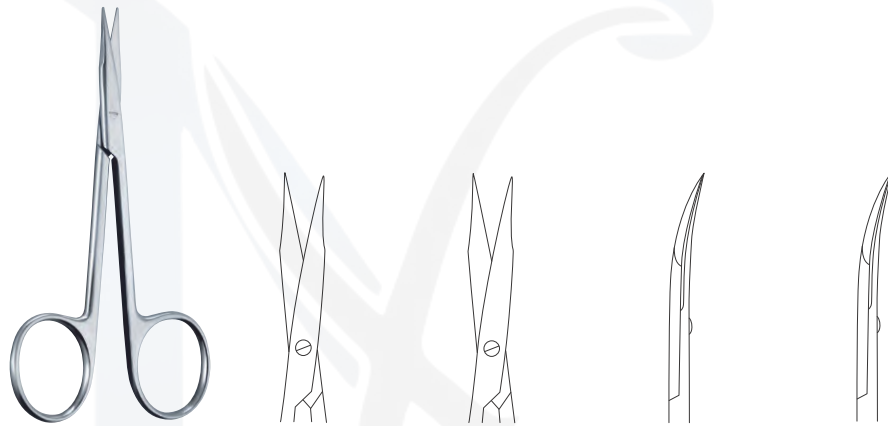

STEVENS

		Supercut		Supercut
90 mm – 3 ½ "	02-312-090			
100 mm – 4 "	02-589-100	02-590-100	02-592-100	02-591-100
110 mm – 4 ¼ "	02-372-115	02-590-110	02-373-115	02-591-110

spitz – spitz
sharp – sharp
pointue – pointue
roma – roma
acuta – acuta

Sehnenscheren Tenotomy scissors

Ciseaux à ténatomie
Tijeras para tenotomía
Forbici per tenotomia

TC



STEVENS

		Supercut	Ceramic Cut		Supercut	Ceramic Cut
90 mm – 3 ½ "	02-374-090					
100 mm – 4 "	02-593-100			02-594-100		
110 mm – 4 ¼ "	02-312-115	307-358-110	02-595-110K	02-375-115	02-597-110	02-596-110K
130 mm – 5 "			02-595-130K			02-596-130K

stumpf – stumpf
blunt – blunt
mousse – mousse
aguda – aguda
smussa – smussa

NEOA
INDUSTRY



WALTON

1:2

100 mm – 4 " 02-597-100



GRAEFE

1:2

105 mm – 4 ¼ " 02-380-100

**Strabismusscheren
Strabismus scissors**

*Ciseaux à strabisme
Tijeras para estrabismo
Forbici per strabismo*

TC

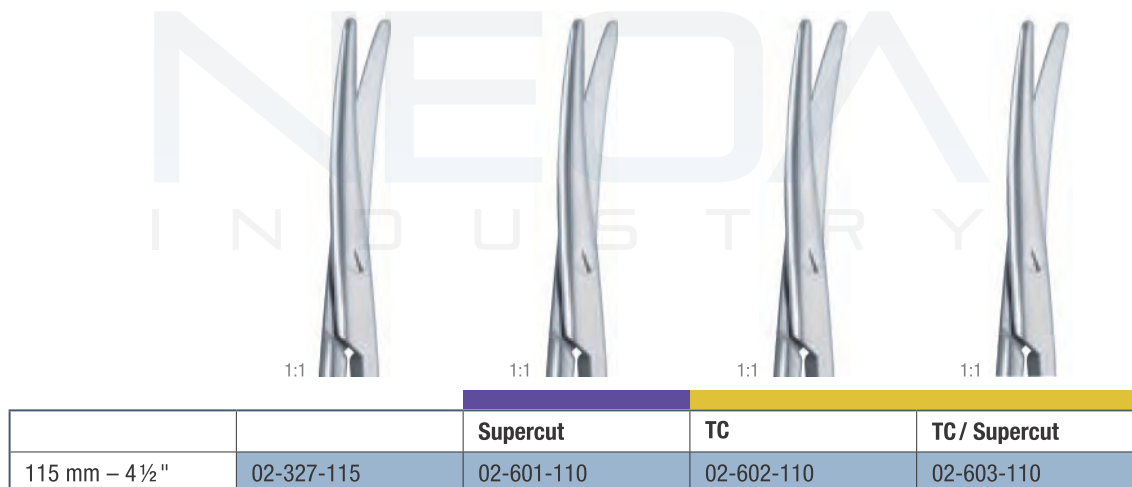
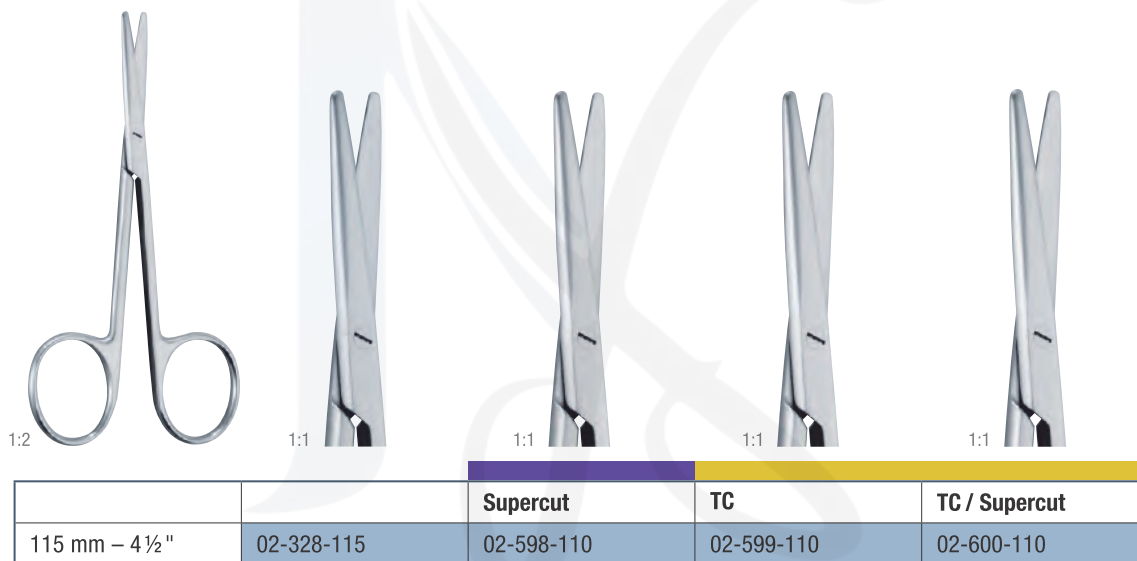

Anatomische Scheren
Anatomy scissors

Ciseaux à dissequer
Tijeras para anatomía
Forbici per anatomia



110 mm – 4 1/8 "

02-604-110



02-605-110

NEOA
INDUSTRY

Durascheren *Dura scissors*

Ciseaux pour la duremère
Tijeras para dura-madre
Forbici per dura-madre



TAYLOR

1:2

145 mm – 5¾"

02-606-145



SCHMIEDEN

1:2

170 mm – 6¾"

02-607-170



DANDY

1:2

170 mm – 6¾"

02-608-170



1:2

STRULLY

1:2

220 mm – 8¾"

02-609-220

1:2

02-610-220

Ligaturscheren Ligature scissors

Ciseaux à ligature
Tijeras para ligaduras
Forbici per sutura



LITTAUER 1:2

140 mm – 5½"	02-381-140
--------------	------------



O'BRIEN 1:2

90 mm – 3½"	02-382-090
-------------	------------



BUCK

145 mm – 5¾"	02-611-140
180 mm – 7"	02-611-180



1:2

115 mm – 4½"	02-383-115
--------------	------------



SPENCER

90 mm – 3½"	02-384-090	02-383-090
110 mm – 4⅓"	02-384-110	
130 mm – 5"	02-384-130	

seitwärts gebogen
laterally curved
courbes laterale
curva lateral
curvata eralmente

Ligaturscheren Ligature scissors

Ciseaux à ligature
Tijeras para ligaduras
Forbici per sutura



NORTHBENT

90 mm – 3 ½"	02-612-090
125 mm – 5"	02-612-130



HEATH 1:2

150 mm – 6"	
02-385-150	

gezahnt
saw edge
dentelés
dentada
dentata



1:2

120 mm – 4 ¾"	
02-613-120	

gezahnt
saw edge
dentelés
dentada
dentata



EISELSBERG 1:2

115 mm – 4 ½"	02-614-120
---------------	------------



1:2.2

90 mm – 3 ½"	02-281-090
--------------	------------

NEOA
INDUSTRY

Drahtscheren
Wire cutting scissors

Cisailles pour fils
Cizallas para cortar alambre
Forbici per filo metallico

TC

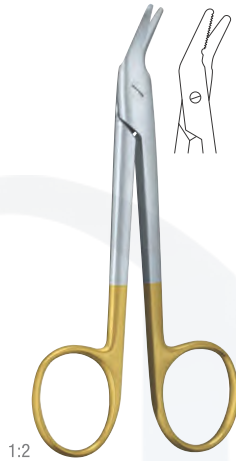
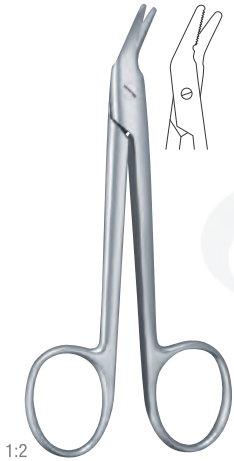

1:2
UNIVERSAL

1:2

1:2
HARVEY

1:2
SCHUKNECHT

	TC
120 mm – 4 3/4"	120 mm – 4 3/4"
02-386-120	02-615-120

125 mm – 5"
02-616-120

125 mm – 5"
02-388-125

gezahnt
saw edge
dentelés
dentada
dentata

gezahnt
saw edge
dentelés
dentada
dentata

gezahnt
saw edge
dentelés
dentada
dentata

gezahnt
saw edge
dentelés
dentada
dentata

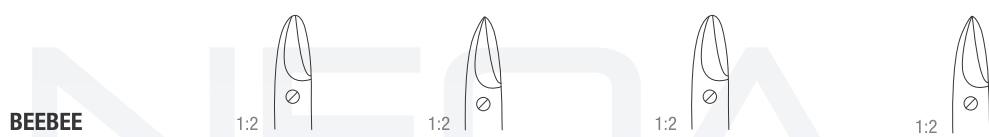

BEEBEE

105 mm – 4"	02-389-105	02-390-105	02-391-105	02-392-105
-------------	------------	------------	------------	------------

gerade
straight
droits
recta
rette

stumpf – stumpf
blunt – blunt
mousse – mousse
aguda – aguda
smussa – smussa

spitz – spitz
sharp – sharp
pointue – pointue
roma – roma
acuta – acuta

stumpf – stumpf, gezahnt
blunt – blunt, saw edge
mousse – mousse, dentelée
roma – roma, dentada
smussa – smussa, dentata

spitz – spitz, gezahnt
sharp – sharp, saw edge
pointue – pointue, dentelée
aguda – aguda, dentada
acuta – acuta, dentata

1:2

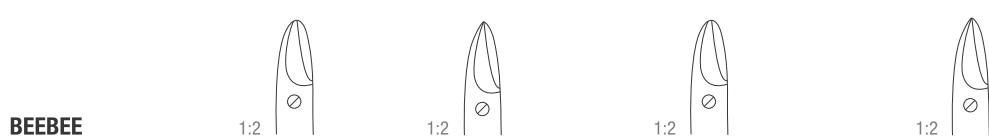

BEEBEE

105 mm – 4"	02-393-105	02-394-105	02-395-105	02-396-105
-------------	------------	------------	------------	------------

gebogen
curved
courbes
curva
curve

stumpf – stumpf
blunt – blunt
mousse – mousse
aguda – aguda
smussa – smussa

spitz – spitz
sharp – sharp
pointue – pointue
roma – roma
acuta – acuta

stumpf – stumpf, gezahnt
blunt – blunt, saw edge
mousse – mousse, dentelée
roma – roma, dentada
smussa – smussa, dentata

spitz – spitz, gezahnt
sharp – sharp, saw edge
pointue – pointue, dentelée
aguda – aguda, dentada
acuta – acuta, dentata

1:2

**Verbandscheren
Bandage scissors**

*Ciseaux pour pansements
Tijeras para vendajes
Forbici per bendaggi*

TC



UNIVERSAL

140 mm – 5 ½"	02-397-140
180 mm – 7"	02-397-180



LISTER

180 mm – 7"	02-398-180
200 mm – 8"	02-398-200



LISTER

		Supercut	TC
90 mm – 3 ½"	02-399-090		
110 mm – 4 ¼"	02-399-110		
140 mm – 5 ½"	02-399-145	02-617-140	02-618-140
155 mm – 6"	02-399-155		
180 mm – 7"	02-399-180	02-617-180	02-618-180
200 mm – 8"	02-399-200	02-617-200	02-618-200

**Verbandscheren
Bandage scissors**

*Ciseaux pour pansements
Tijeras para vendajes
Forbici per bendaggi*



LANGE

1:2

180 mm – 7"

02-619-180



KNOWLES

1:2

140 mm – 5 ½"

02-620-140



1:2

160 mm – 6 ¼"

02-400-160



SMITH (MOD. USA)

160 mm – 6 ¼" 02-401-160

180 mm – 7" 02-401-180

200 mm – 8" 02-401-200

230 mm – 9" 02-401-230

Verband- und Gipsscheren
Bandage scissors – Plaster shears

Ciseaux pour pansements et plâtres
Tijeras para vendajes y vendajes enyesados
Cesoie per bendaggi ed apparecchi gessati



ESMARCH

200 mm – 8 "	02-621-200
220 mm – 8 ¾ "	02-621-220



EXCENTRIC

160 mm – 6 ¼ "	02-637-160
190 mm – 7 ½ "	02-637-190

gezahnt
saw edge
dentelés
dentadas
dentata



BERGMANN

230 mm – 9 "	02-627-230
--------------	------------



LORENZ

230 mm – 9 "	02-639-230
--------------	------------

1:2

1:2

Gipsscheren
Plaster shears

Cisailles pour plâtre
Cizallas para vendajes enyesados
Cesoie per apparecchi gessati

TC

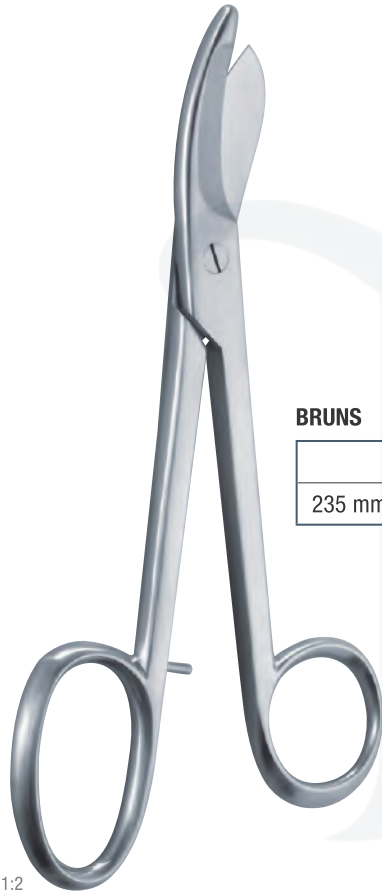

1:2

BRUNS

1:2



1:2



1:2



		TC	
235 mm – 9 ¼ "	02-402-230	02-645-230	02-403-230

gezahnt
saw edge
dentelés
dentadas
dentate



1:2

200 mm – 8 " 02-404-200



1:2

SEUTIN

230 mm – 9 " 02-646-230

Hautscheren – Nagelscheren
Cuticle scissors – Nail scissors

Ciseaux à envies – Ciseaux à ongles
Tijeras cuticulares – Tijeras para uñas
Forbici per unghie e cuticole



105 mm – 4 ¼ "	02-274-105	02-275-105
115 mm – 4 ½ "	02-274-115	02-275-115



90 mm – 3 ½ "	02-280-090	02-281-090
100 mm – 4 "	02-647-100	02-648-100
110 mm – 4 ¼ "	02-647-110	02-648-110

Nagelspaltscheren
Nail splitting scissors

Ciseaux à ongles
Tijeras para uñas
Forbici per unghie



130 mm – 5 "	02-650-130
150 mm – 6 "	02-650-150



SYSTRUNK 1:2

1:2

1:2

130 mm – 5 "	02-651-130	02-652-130
--------------	------------	------------

Nagelzangen
Nail nippers
Pinces à ongles
Pinzas corta-uñas
Forbici e tronchesine per unghie



110 mm – 4 ¼"	02-653-110
130 mm – 5"	02-653-130
150 mm – 6"	02-653-150



140 mm – 5 ½"	02-443-140
---------------	------------



140 mm – 5 ½"	02-444-140
---------------	------------



TURNBULL

115 mm – 4 ½"	02-654-110
130 mm – 5"	02-448-130



115 mm – 4 ½"	02-445-115
---------------	------------



COHEN

105 mm – 4 ¼"	02-446-105
---------------	------------



Manufacturer & Supplier Premium Quality Surgical, Dental, Podiatry, Pet Grooming and Beauty Care Instruments.

USA Address:

 5900 Balcones Drive # 16244
Austin TX, USA 78731.
 +1 (917) 773 3694
 **uk:** +44 7871 836765
 info@neoaindustry.com
neoaindustry4@gmail.com
 www.neoaindustry.com

Main Head Office:

 Roars Road New Miana Pura
West, Sialkot 51310 Pakistan.
 +92 322 5587688
 +92 322 5587688
 info@neoaindustry.com
neoaindustry4@gmail.com
 www.neoaindustry.com

