

» Gefäßchirurgie

» Vascular surgery

» Chirurgie vasculaire

» Cirugía vascular

» Chirurgia vascolare



Gefäßstripper Vein stripper

Tire-veines
Fleboextractores
Tiravene



	1:1	1:1	1:1	1:1	1:1
	2 mm Ø	3 mm Ø	4 mm Ø	5 mm Ø	6 mm Ø
500 mm – 20 "	05-101-020	05-101-030	05-101-040	05-101-060	05-101-070

	1:1	1:1	1:1	1:1
	8.5 mm Ø	10 mm Ø	12 mm Ø	14 mm Ø
500 mm – 20 "	05-101-080	05-101-100	05-101-120	05-101-140



1:2



1:2

120 mm – 4 3/4 "	05-102-120
------------------	------------

Griff für 05-101-020 – 05-101-140
Handle for 05-101-020 – 05-101-140
Manche pour 05-101-020 – 05-101-140
Mango para 05-101-020 – 05-101-140
Manico per 05-101-020 – 05-101-140



RUMEL-BELM • NT

	3.2 mm Ø	6.4 mm Ø		3.2 mm Ø	6.4 mm Ø
325 mm – 12 3/4 "	05-106-320	05-106-640		05-107-001	05-107-002

Tourniquet
Tourniquet
Tourniquet
Torniquete
Tourniquet

für Kinder
for children
pour enfants
para niños
per bambini

für Erwachsene
for adults
pour adultes
para adultos
per adulti

Führungsnadel, alleine
Guide only
pour adultes
para adultos
per adulti

für Kinder
for children
pour enfants
para niños
per bambini

für Erwachsene
for adults
pour adultes
para adultos
per adulti

Krampfaderbesteck
Varicose vein probe set

Trousse à varices
Juego para várices
Astuccio per varici



1:2

NABAT • FF

135 mm x 100 mm x 25 mm

05-108-000

komplett
complete
complet
completo
completo

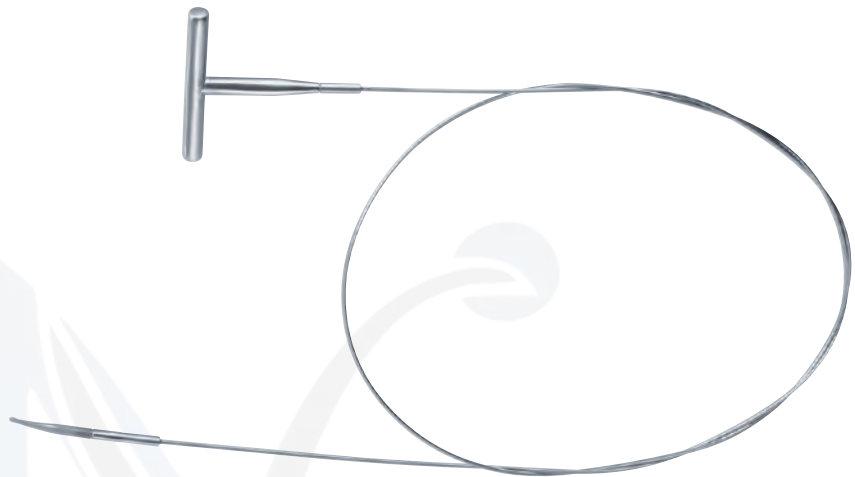

1:1



3 mm Ø

1:1



6 mm Ø

1:1



9 mm Ø

1:1



12 mm Ø

05-109-010	05-109-800	05-109-900	05-109-020
Metalletui Metal case Boîte métal Estuche Astuccio	Griff Handle Manche Mango Manico	Zugseil 900 mm Cable 900 mm Corde à traction 900 mm Cordón 900 mm Funne di trazione 900 mm	Sondenspitze, Kunststoff Probe tip in plastic Sonde en plastique Extremidad de sonda, plástica Punta di plastica

1:1



3 mm Ø

05-109-030

Sonde
Probe
Sonde
Sonda
Sonda

1:1



6 mm Ø

05-109-060

Olive
Olive
Olive
Oliva
Oliva

1:1



9 mm Ø

05-109-090

1:1



12 mm Ø

05-109-120

1:1



15 mm Ø

05-109-150

Bulldogklemmen
Bulldog clamps
Clamps Bulldog
Clamps Bulldog
Pinze Bulldog



**J • HNS-
H • PKINS**

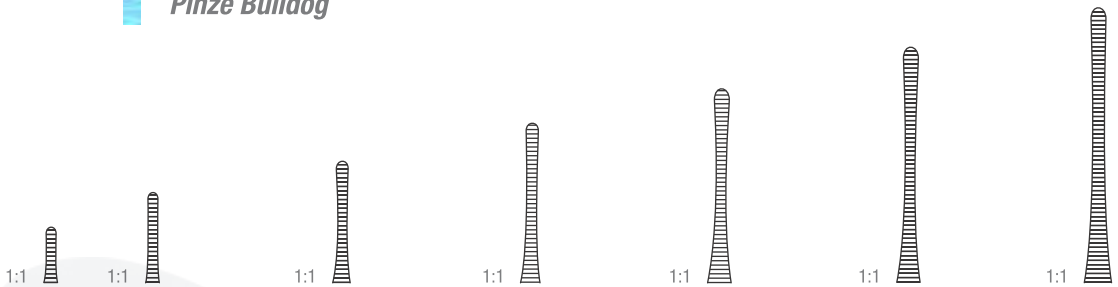

38 mm – 1 ½ "	51 mm – 2 "	57 mm – 2 ¼ "	63 mm – 2 ½ "	70 mm – 2 ¾ "	75 mm – 3 "	90 mm – 3 ½ "
05-128-038	05-128-051	05-128-057	05-128-063	05-128-070	05-128-075	05-128-090

**J • HNS-
H • PKINS**

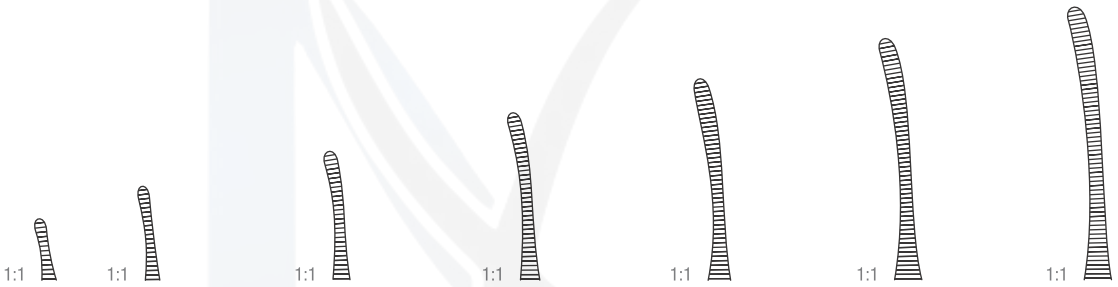

38 mm – 1 ½ "	51 mm – 2 "	57 mm – 2 ¼ "	63 mm – 2 ½ "	70 mm – 2 ¾ "	75 mm – 3 "	90 mm – 3 ½ "
05-129-038	05-129-051	05-129-057	05-129-063	05-129-070	05-129-075	05-129-090



1:2

245 mm – 9 ¾ "

05-131-245

Anlegezange für Bulldogklemmen
 Applying forceps for Bulldog clamps
 Pince pour poser les clamps Bulldog
 Pinza aplicadora para clamps Bulldog
 Pinza per posizionare le pinze Bulldog

Bulldogklemmen
Bulldog clamps
Clamps Bulldog
Clamps Bulldog
Pinze Bulldog

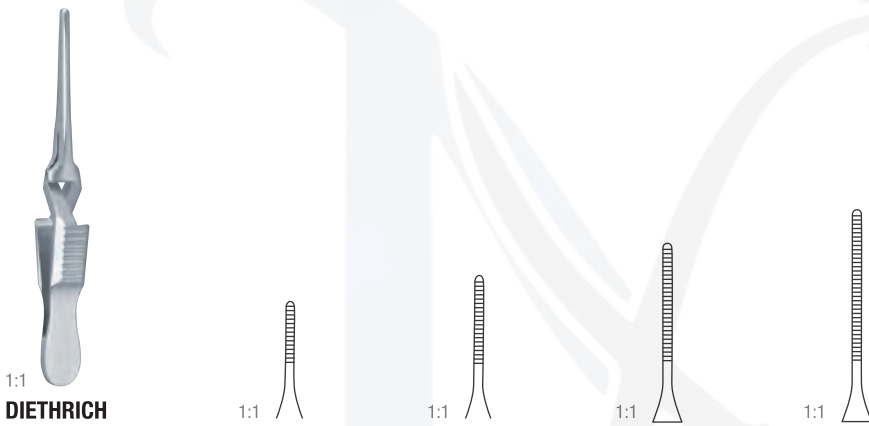

1:1
DIETRICH

	8 mm	12 mm	16 mm	20 mm
50 mm – 2 "	05-132-008	05-132-012	05-132-016	05-132-020

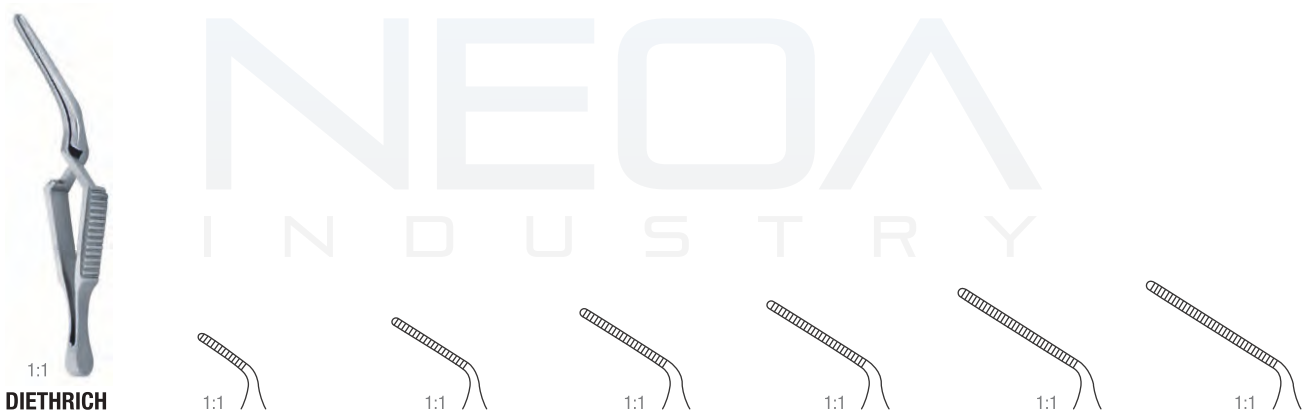

1:1
DIETRICH

	8 mm	12 mm	13 mm	16 mm	18 mm	20 mm
50 mm – 2 "	05-133-008	05-133-012	05-133-013	05-133-016	05-133-018	05-133-020

Bulldogklemmen Bulldog clamps

Clamps Bulldog
Clamps Bulldog
Pinze Bulldog

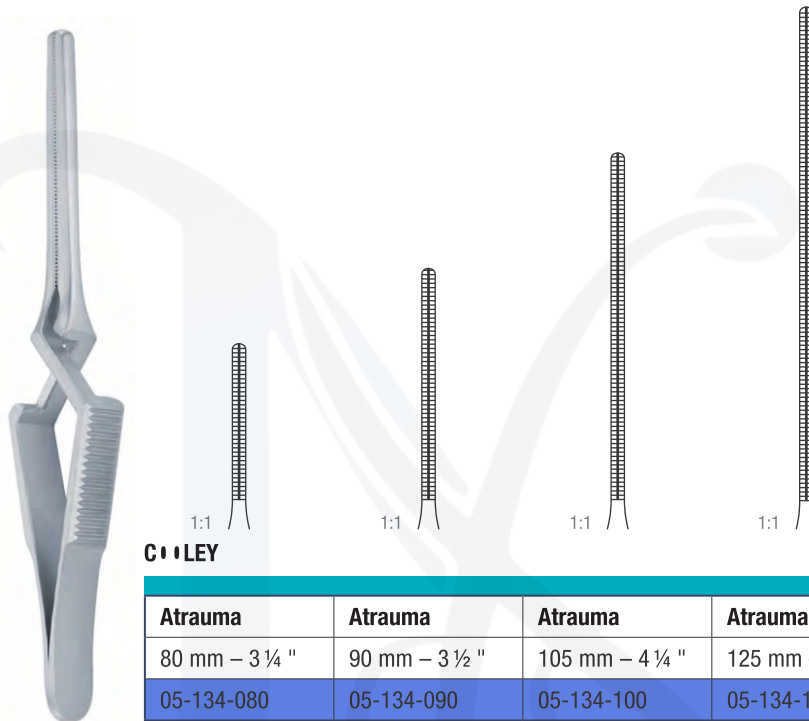

C•ILEY

Atrauma	Atrauma	Atrauma	Atrauma
80 mm – 3 ¼ "	90 mm – 3 ½ "	105 mm – 4 ¼ "	125 mm – 5 "
05-134-080	05-134-090	05-134-100	05-134-120

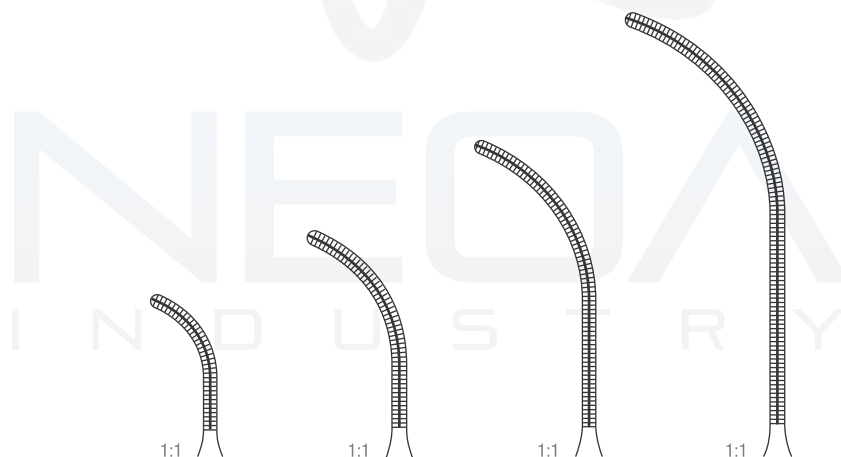

C•ILEY

Atrauma	Atrauma	Atrauma	Atrauma
80 mm – 3 ¼ "	90 mm – 3 ½ "	105 mm – 4 ¼ "	125 mm – 5 "
05-135-080	05-135-090	05-135-100	05-135-120

Bulldogklemmen Bulldog clamps

Clamps Bulldog
Clamps Bulldog
Pinze Bulldog

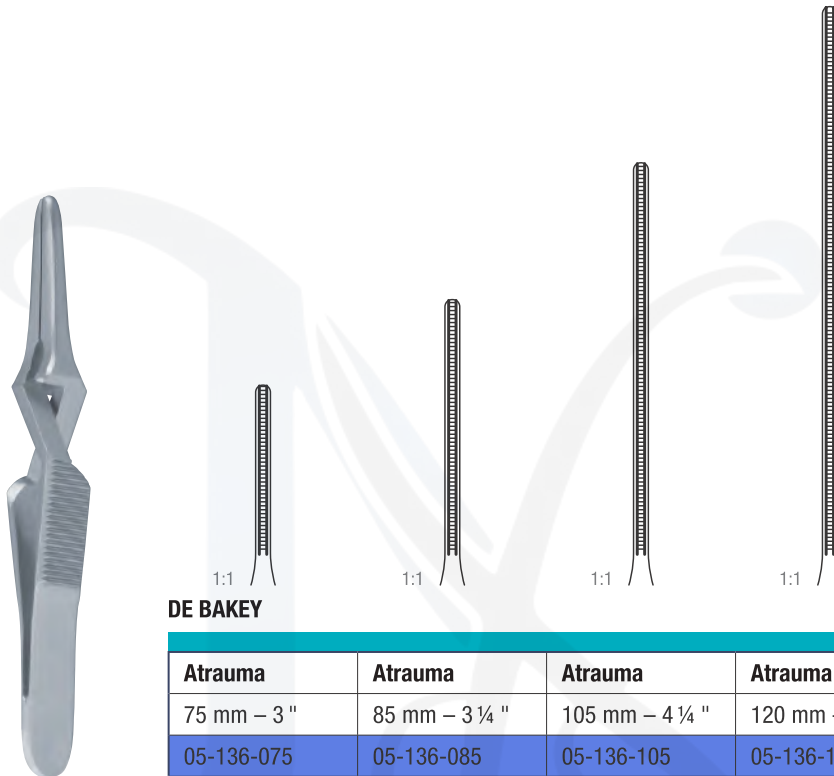

DE BAKEY

Atrauma	Atrauma	Atrauma	Atrauma
75 mm – 3 "	85 mm – 3 ¼ "	105 mm – 4 ¼ "	120 mm – 4 ¾ "
05-136-075	05-136-085	05-136-105	05-136-120

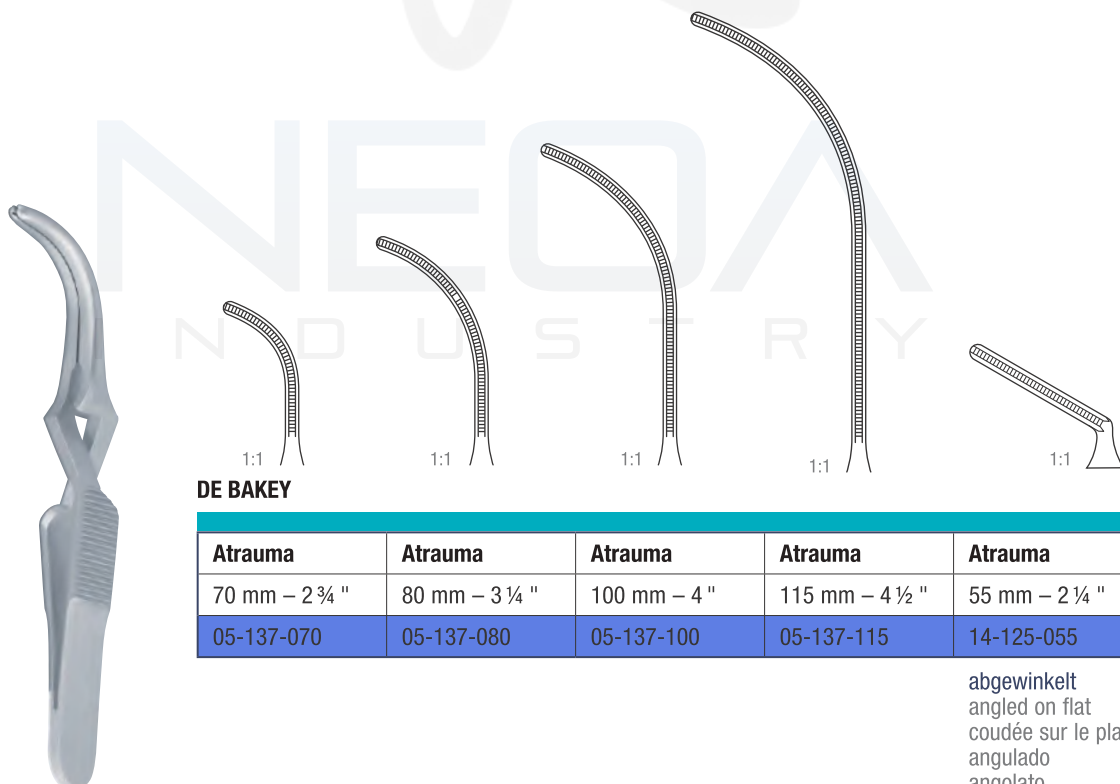

DE BAKEY

Atrauma	Atrauma	Atrauma	Atrauma	Atrauma
70 mm – 2 ¾ "	80 mm – 3 ¼ "	100 mm – 4 "	115 mm – 4 ½ "	55 mm – 2 ¼ "
05-137-070	05-137-080	05-137-100	05-137-115	14-125-055

abgewinkelt
angled on flat
coudée sur le plat
angulado
angolato

Bulldogklemmen

Bulldog clamps

Clamps Bulldog
Clamps Bulldog
Pinze Bulldog

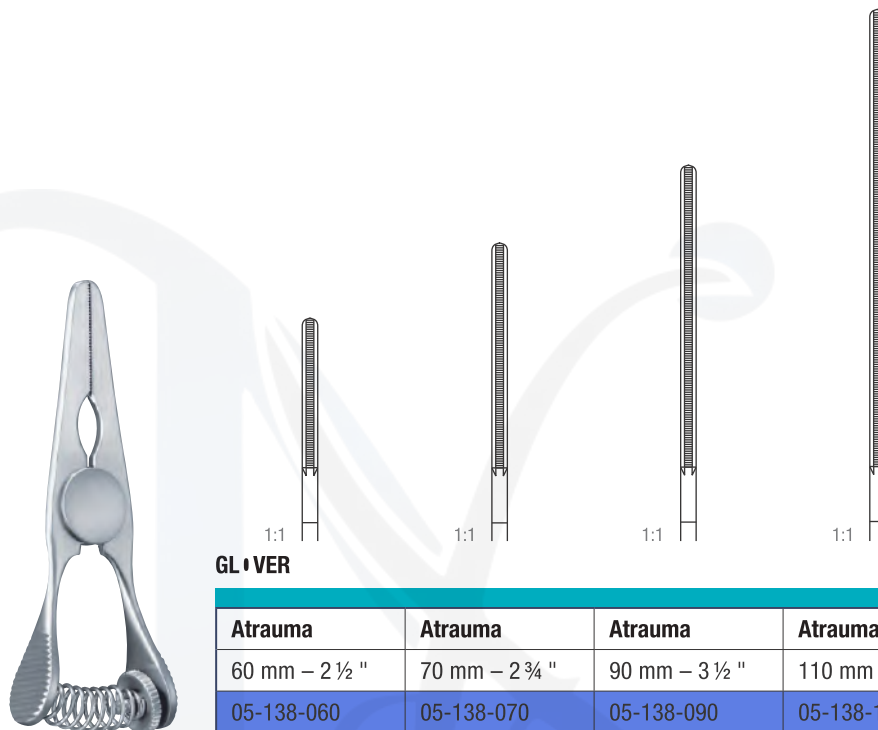

GL • VER

Atrauma	Atrauma	Atrauma	Atrauma
60 mm – 2 ½ "	70 mm – 2 ¾ "	90 mm – 3 ½ "	110 mm – 4 ¼ "
05-138-060	05-138-070	05-138-090	05-138-110

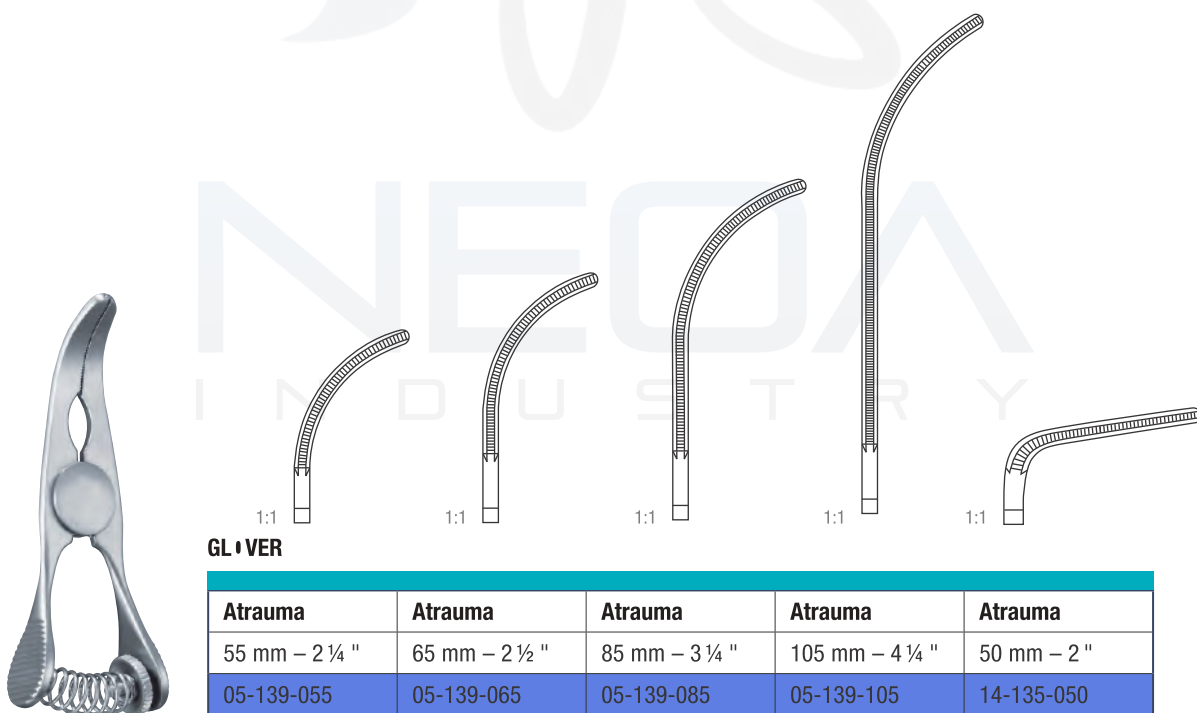

GL • VER

Atrauma	Atrauma	Atrauma	Atrauma	Atrauma
55 mm – 2 ¼ "	65 mm – 2 ½ "	85 mm – 3 ¼ "	105 mm – 4 ¼ "	50 mm – 2 "
05-139-055	05-139-065	05-139-085	05-139-105	14-135-050

abgewinkelt
angled on flat
coudée sur le plat
angulado
angolato

Bulldogklemmen Bulldog clamps

Clamps Bulldog
Clamps Bulldog
Pinze Bulldog

TC



1:1
DE BAKEY-SATINSKY

Atrauma
70 mm – 2 ¾ "
05-140-070



1:1
DE BAKEY-CAR • TIS

Atrauma
90 mm – 3 ½ "
05-141-090

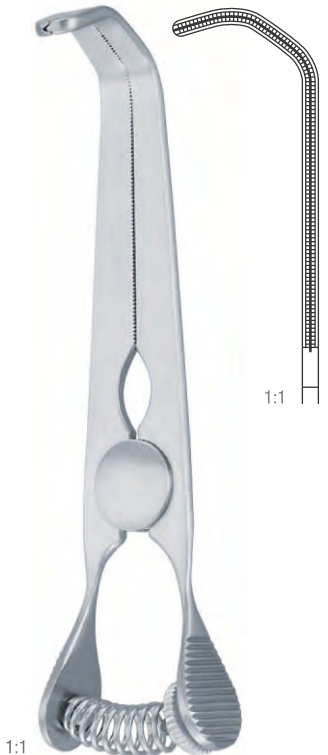

1:1
DE BAKEY-SATINSKY

Atrauma
100 mm – 4 "
05-142-100

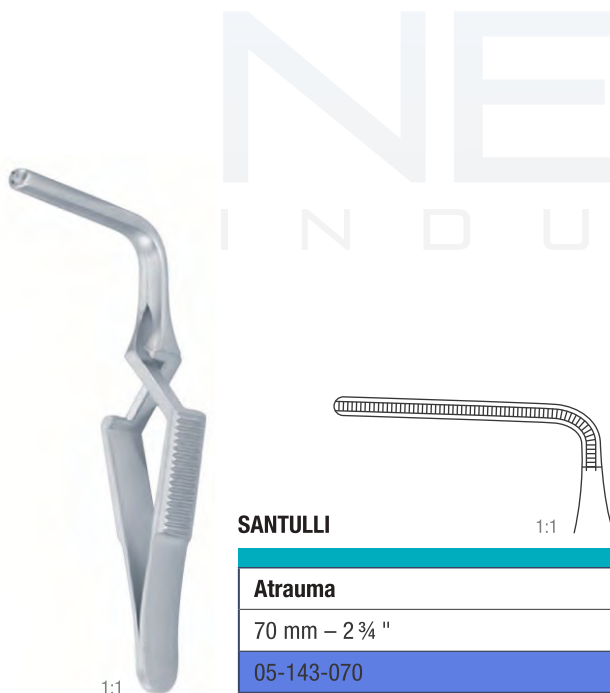

SANTULLI

Atrauma
70 mm – 2 ¾ "
05-143-070

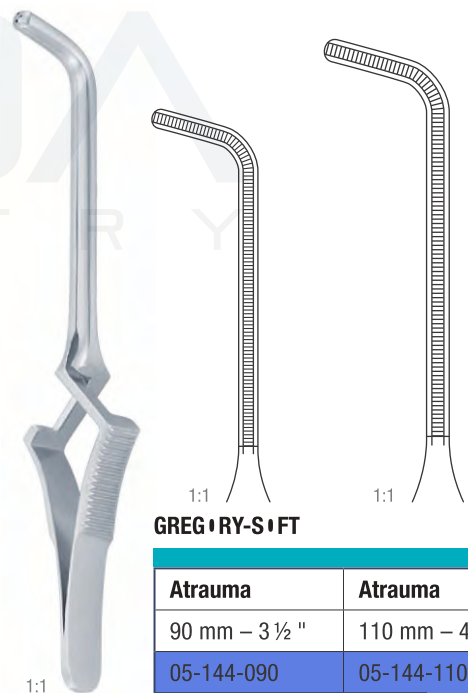

GREG • RY-S • FT

Atrauma	Atrauma
90 mm – 3 ½ "	110 mm – 4 ¼ "
05-144-090	05-144-110

Atraumatische pinzetten
Atraumatic tissue forceps

Pinces atraumáticas
Pinzas atraumáticas de disección
Pinze atraumatiche per dissezione

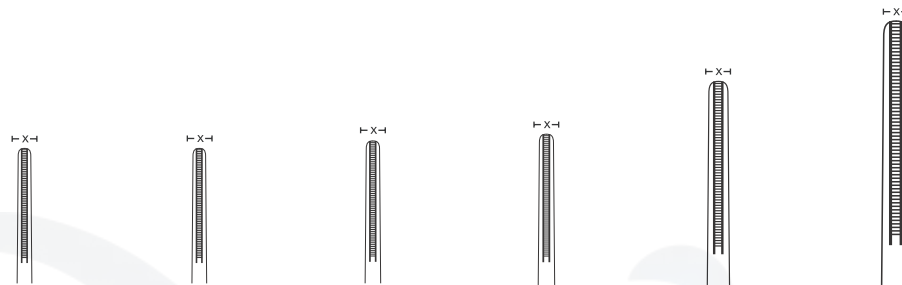

DE BAKEY

	Atrauma	Atrauma	Atrauma	Atrauma	Atrauma	Atrauma
	x = 1.0 mm	x = 1.2 mm	x = 1.5 mm	x = 2.0 mm	x = 2.8 mm	x = 3.5 mm
150 mm – 6 "	05-145-150	05-146-150	05-147-150	05-148-150	05-149-150	05-150-150
200 mm – 8 "	05-145-200	05-146-200	05-147-200	05-148-200	05-149-200	05-150-200
240 mm – 9 ½ "	05-145-240	05-146-240	05-147-240	05-148-240	05-149-240	05-150-240
300 mm – 12 "		05-146-300	05-147-300	05-148-300	05-149-300	05-150-300
350 mm – 13 ¾ "				05-148-350	05-149-350	05-150-350
380 mm – 15 "					05-149-380	05-150-380
400 mm – 15 ¾ "					05-149-400	



DE BAKEY

	Light weight	Light weight	Light weight
	x = 1.2 mm	x = 1.5 mm	x = 2.0 mm
150 mm – 6 "	05-145-150 LW		05-148-150 LW
200 mm – 8 "		05-145-200 LW	
240 mm – 9 ½ "		05-145-240 LW	
300 mm – 12 "		05-145-300 LW	

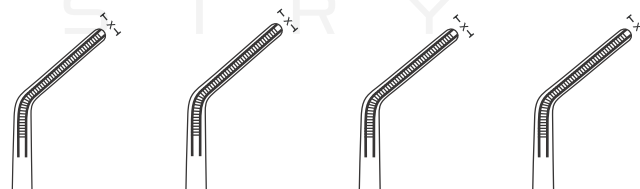

DE BAKEY

	Atrauma	Atrauma	Atrauma	Light weight
	x = 1.5 mm	x = 2.0 mm	x = 3.5 mm	x = 2.0 mm
150 mm – 6 "	05-151-150	05-152-150	05-153-150	05-152-150 LW
200 mm – 8 "		05-152-200	05-153-200	
240 mm – 9 ½ "		05-152-240	05-153-240	
300 mm – 12 "		05-152-300	05-153-300	

Atraumatische pinzetten
Atraumatic tissue forceps

Pinces atraumáticas
Pinzas atraumáticas de disección
Pinze atraumatiche per dissezione

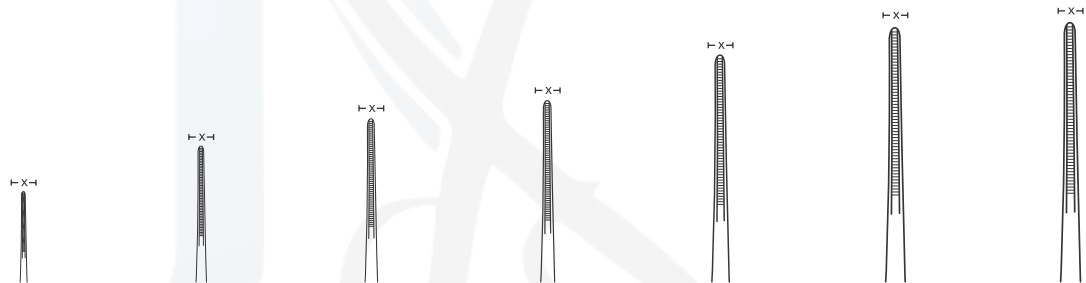

DE BAKEY

	Titan / Atrauma	Titan / Atrauma	Titan / Atrauma	Titan / Atrauma	Titan / Atrauma	Titan / Atrauma	Titan / Atrauma
	x = 1.0 mm	x = 1.5 mm	x = 1.8 mm	x = 2.0 mm	x = 2.5 mm	x = 2.8 mm	x = 3.5 mm
150 mm – 6 "	05-154-150	05-155-150	05-156-150	05-157-150	05-158-150	05-160-150	05-166-150
200 mm – 8 "	05-154-200	05-155-200	05-156-200	05-157-200	05-158-200	05-160-200	05-166-200
240 mm – 9 ½ "	05-154-240	05-155-240	05-156-240	05-157-240	05-158-240	05-160-240	05-166-240
300 mm – 12 "				05-157-300	05-158-300	05-160-300	05-166-300
350 mm – 13 ¾ "							05-166-350

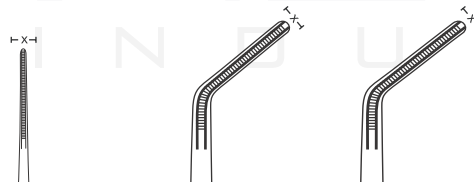

DE BAKEY

	Titan / Atrauma	Titan / Atrauma	Titan / Atrauma
	x = 1.5 mm	x = 2.0 mm	x = 2.4 mm
160 mm – 6 ¼ "	05-172-150	05-175-150	
200 mm – 8 "	05-172-200	05-175-200	05-177-200
240 mm – 9 ½ "		05-175-240	
300 mm – 12 "		05-175-300	

Atraumatische pinzetten
Atraumatic tissue forceps

Pinces atraumatiques
Pinzas atraumáticas de disección
Pinze atraumatiche per dissezione

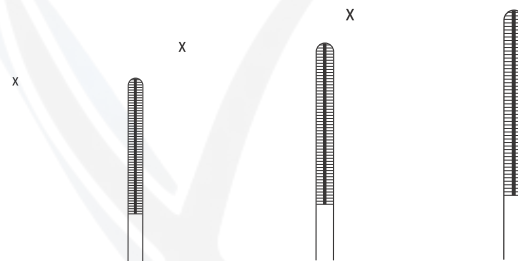

	Atrauma	Atrauma	Atrauma
	x = 2.0 mm	x = 2.5 mm	x = 3.0 mm
150 mm – 6 "	05-178-150	05-179-150	05-180-150
200 mm – 8 "	05-178-200	05-179-200	05-180-200
240 mm – 9 ½ "	05-178-240	05-179-240	05-180-240

rostfrei
stainless
inoxidable
inoxidable
inossidabile

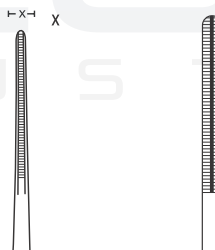

	Titan / Atrauma	Titan / Atrauma
	x = 2.5 mm	x = 3.0 mm
150 mm – 6 "	05-181-150	05-182-150
200 mm – 8 "	05-181-200	05-182-200
240 mm – 9 ½ "	05-181-240	05-182-240



Bulldogklemmen mit Ringgriff
Ring handle Bulldog clamps

Clamps Bulldog, manches à anneaux
Clamps Bulldog, mangos con anillos
Pinze Bulldog con manici ad anelli

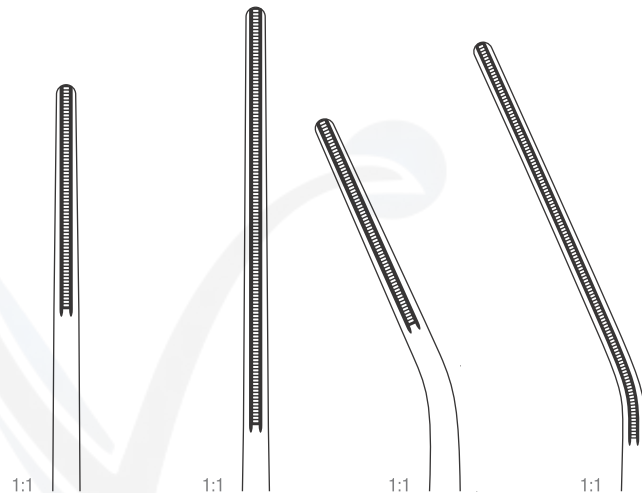

PITTS

Atrauma	Atrauma	Atrauma	Atrauma
200 mm – 8 "	220 mm – 8 ¾ "	200 mm – 8 "	220 mm – 8 ¾ "
05-183-200	05-183-220	05-184-200	05-184-220

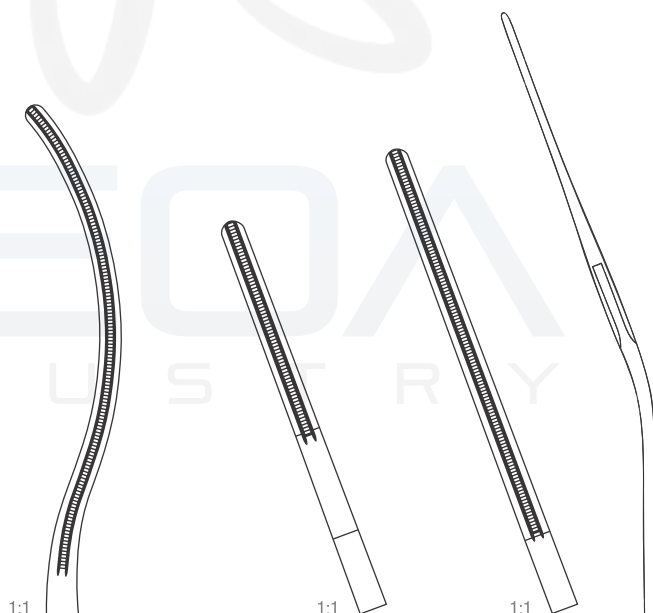

PITTS

Atrauma	Atrauma	Atrauma
220 mm – 8 ¾ "	210 mm – 8 ¼ "	220 mm – 8 ¾ "
05-185-210	05-186-210	05-186-220

Gefäßklemmen
Vascular forceps

Pinces vasculaires
Pinzas vasculares
Pinze vascolari

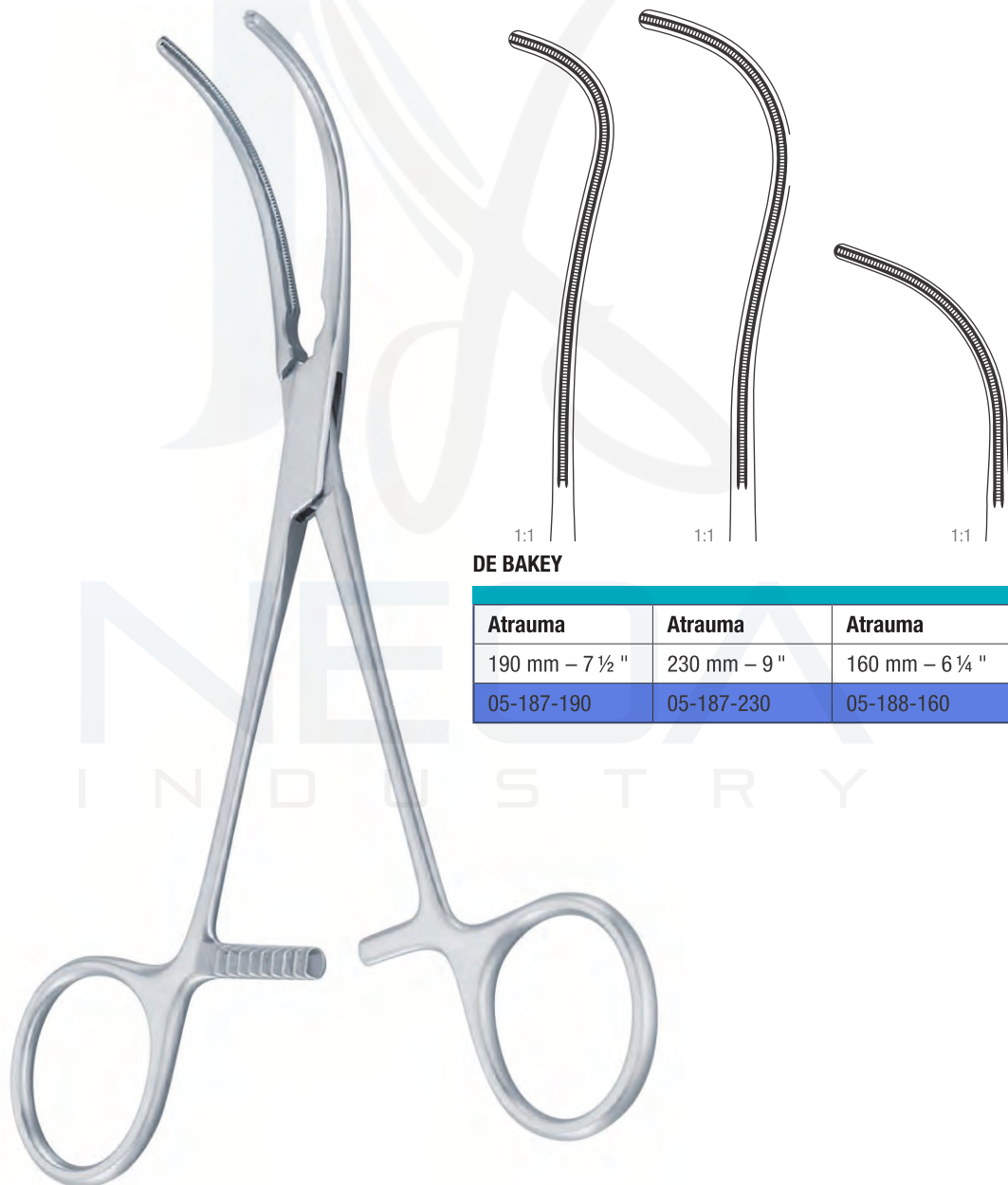

DE BAKEY

Atrauma	Atrauma	Atrauma
190 mm – 7 ½ "	230 mm – 9 "	160 mm – 6 ¼ "
05-187-190	05-187-230	05-188-160

Gefäßklemmen
Vascular forceps

Pinces vasculaires
Pinzas vasculares
Pinze vascolari

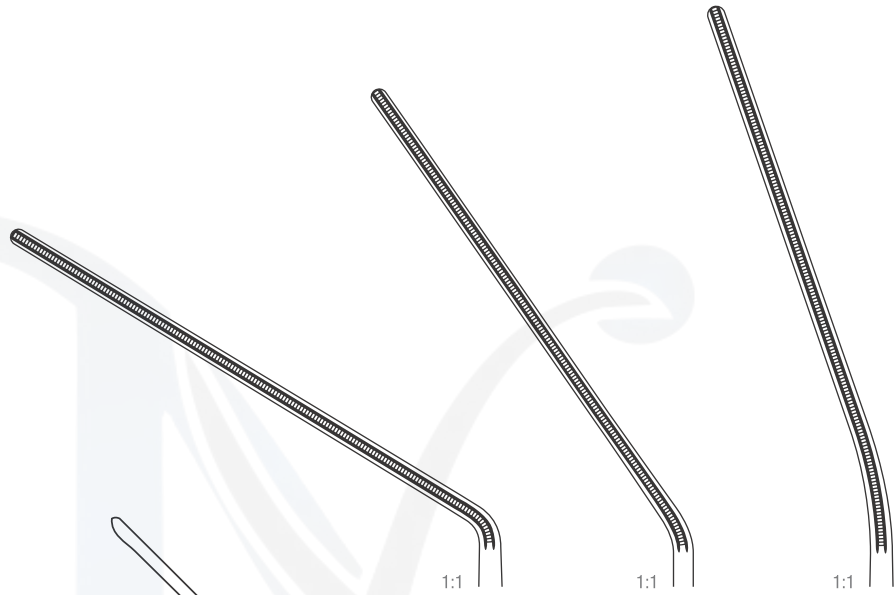

LELAND-JONES

Atrauma	Atrauma	Atrauma
180 mm – 7 "	190 mm – 7 ½ "	200 mm – 8 "
05-189-190	05-190-190	05-191-190

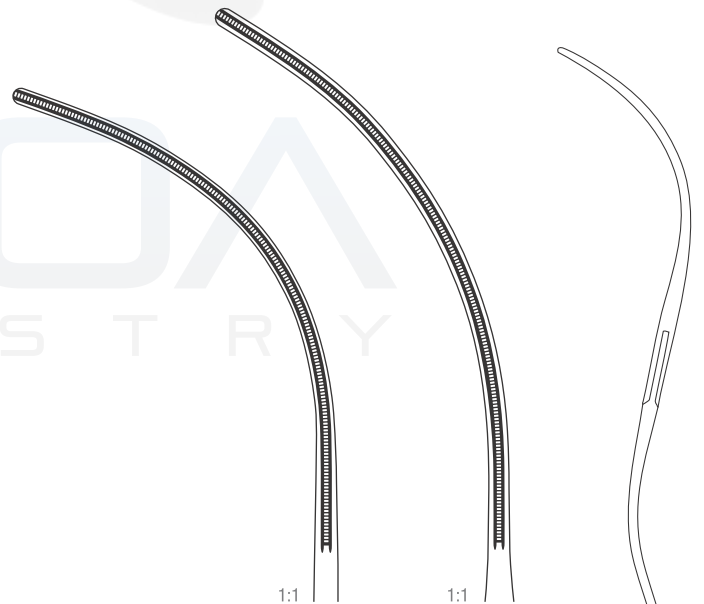

Atrauma	Atrauma
190 mm – 7 ½ "	200 mm – 8 "
05-192-190	05-193-200

Gefäßklemmen
Vascular forceps

Pinces vasculaires
Pinzas vasculares
Pinze vascolari

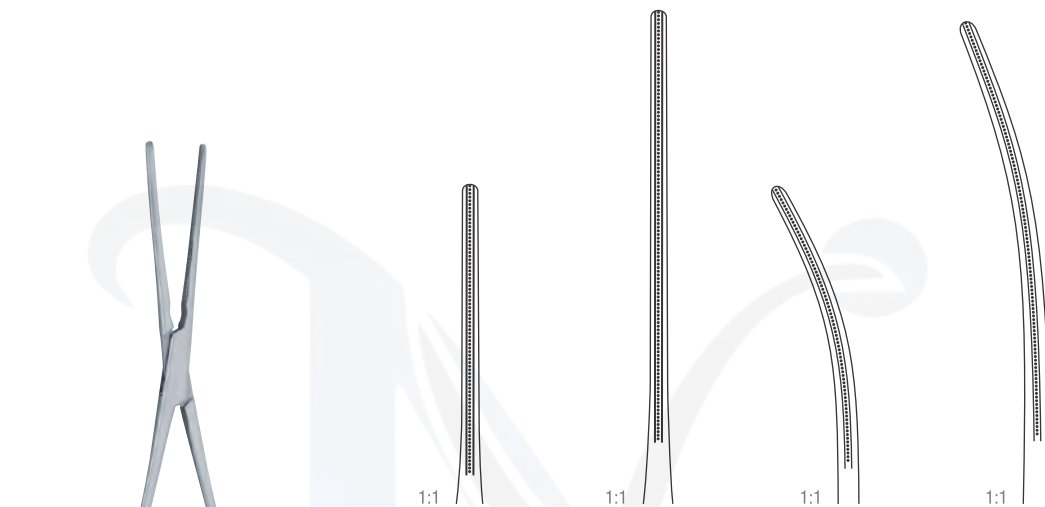

**BAINBRIDGE,
LIGHT**

Atrauma	Atrauma	Atrauma	Atrauma
150 mm – 6 "	180 mm – 7 "	150 mm – 6 "	180 mm – 7 "
05-194-150	05-194-180	05-195-150	05-195-180

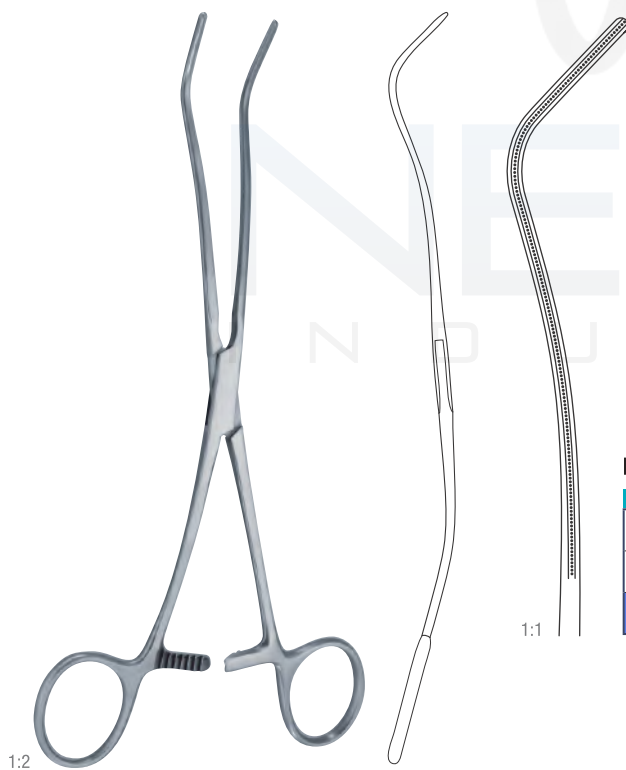

DE BAKY

Atrauma
200 mm – 8 "
05-187-200

S-förmig gebogen
S-curved
courbe en S
curva en S
curva a forma S

Gefäßklemmen
Vascular forceps

Pinces vasculaires
Pinzas vasculares
Pinze vascolari



DE BAKEY

Atrauma	Atrauma	Atrauma	Atrauma
260 mm – 10 ¼ "	270 mm – 10 ¾ "	310 mm – 12 ¼ "	330 mm – 13 ¾ "
05-196-240	05-196-270	05-196-310	05-196-350

C-förmig gebogen
C-curved
courbe en C
curva en C
curva a forma C

Gefäßklemmen
Vascular forceps

Pinces vasculaires
Pinzas vasculares
Pinze vascolari

TC



DE BAKEY

Atrauma	Atrauma
280 mm – 11 "	280 mm – 11 "
05-197-280	05-198-280

S-förmig gebogen
 S-curved
 courbe en S
 curva en S
 curva a forma S

Gefäßklemmen
Vascular forceps

Pinces vasculaires
Pinzas vasculares
Pinze vascolari



1:2

1:1

1:1

1:2

WEBER

Atrauma	Atrauma
260 mm – 10 ¼ "	260 mm – 10 ¼ "
05-199-260	05-200-260

links gebogen
curved left
courbe à gauche
curva a la izquierda
curvata a sinistra

rechts gebogen
curved right
courbe à droite
curva a la derecha
curvata a destra

Gefäßklemmen
Vascular forceps

Pinces vasculaires
Pinzas vasculares
Pinze vascolari

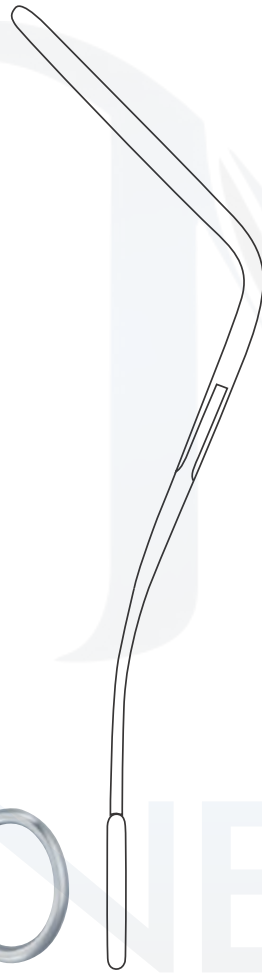

MORRIS-DE BAKEY

Atrauma

180 mm – 7 "

05-201-180

1:1

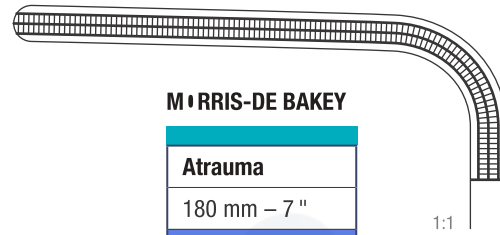

Atrauma

200 mm – 8 "

05-201-200

1:1

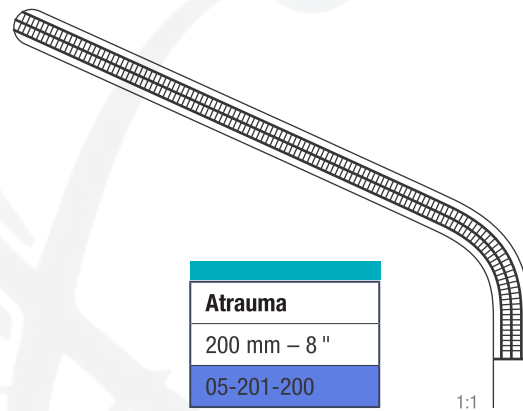

Atrauma

230 mm – 9 "

05-201-230

1:1

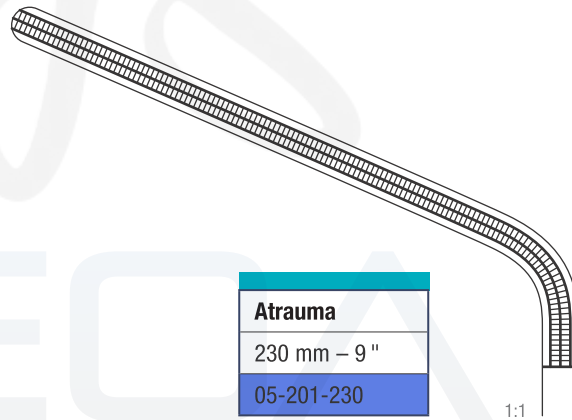

Atrauma

250 mm – 9 ¾ "

05-201-250

1:1

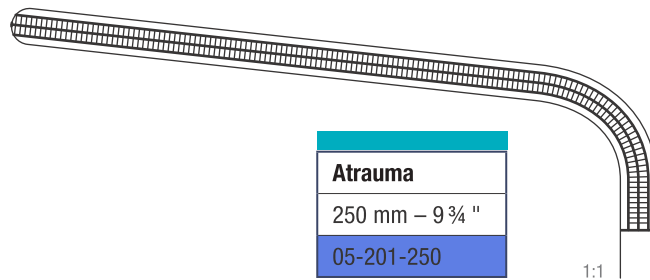

NEOA
INDUSTRY

Gefäßklemmen
Vascular forceps

Pinces vasculaires
Pinzas vasculares
Pinze vascolari

TC

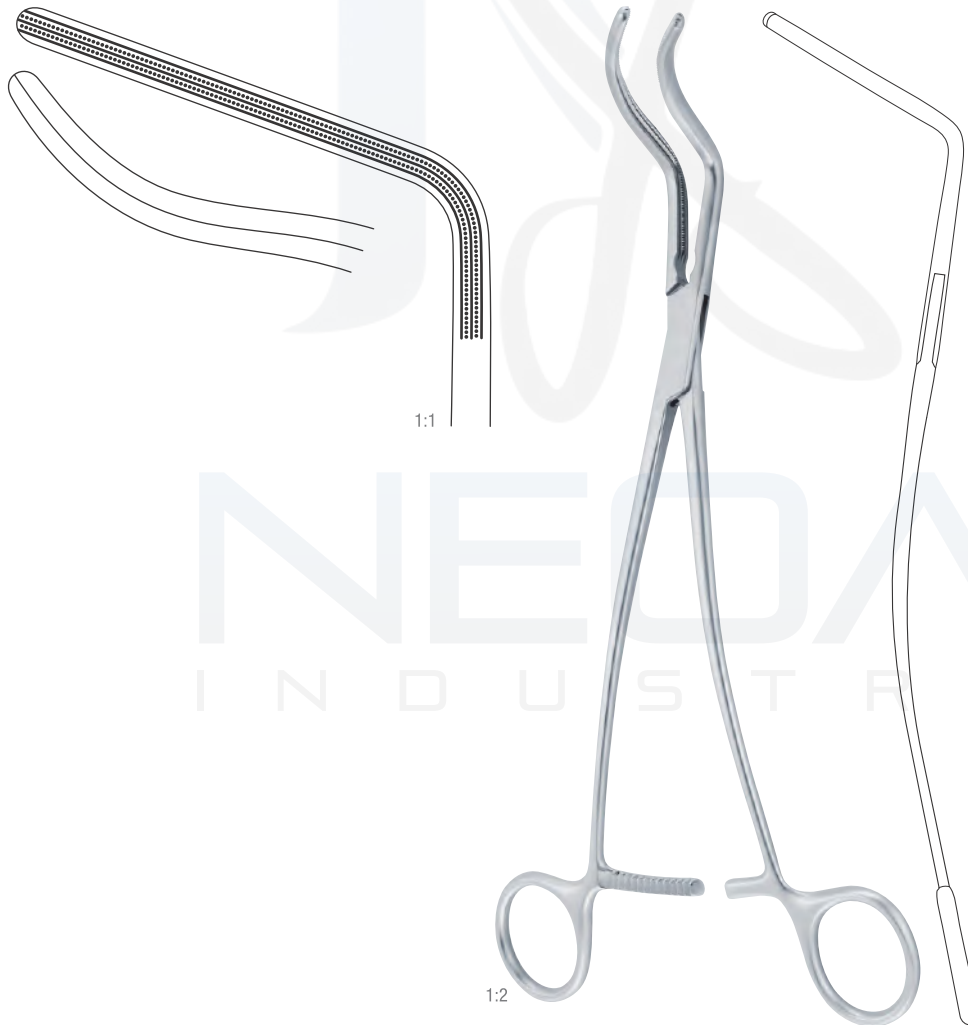

DE BAKEY

Atrauma

270 mm – 10 ¾ "

05-202-270

Gefäßklemmen
Vascular forceps

Pinces vasculaires
Pinzas vasculares
Pinze vascolari



**DE BAKEY-
BAHNS•N**

Atrauma	Atrauma	Atrauma
240 mm – 9 ½ "	250 mm – 9 ¾ "	260 mm – 10 ¼ "
05-203-240	05-203-250	05-203-260

Gefäßklemmen
Vascular forceps

Pinces vasculaires
Pinzas vasculares
Pinze vascolari



DE BAKEY-SEMB

	Atrauma	Atrauma
240 mm – 9 ½ "	05-204-240	05-205-240



DE BAKEY

Atrauma	Atrauma
250 mm – 10 "	260 mm – 10 ¼ "
05-206-250	05-206-260

Gefäßklemmen
Vascular forceps

Pinces vasculaires
Pinzas vasculares
Pinze vascolari



SATINSKY-
DE BAKEY

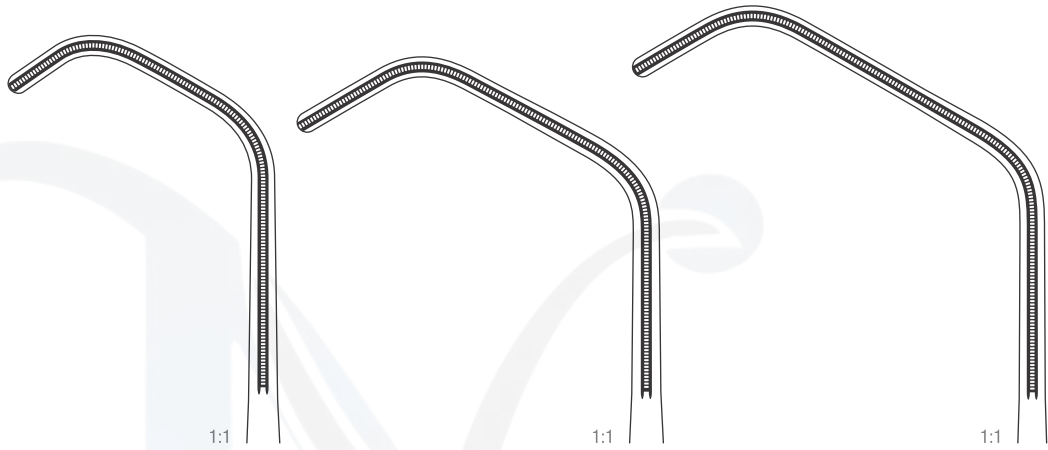

Atrauma	Atrauma	Atrauma
205 mm – 8 "	240 mm – 9 ¼ "	250 mm – 10 "
05-207-200	05-207-240	05-207-250



SATINSKY-
DE BAKEY

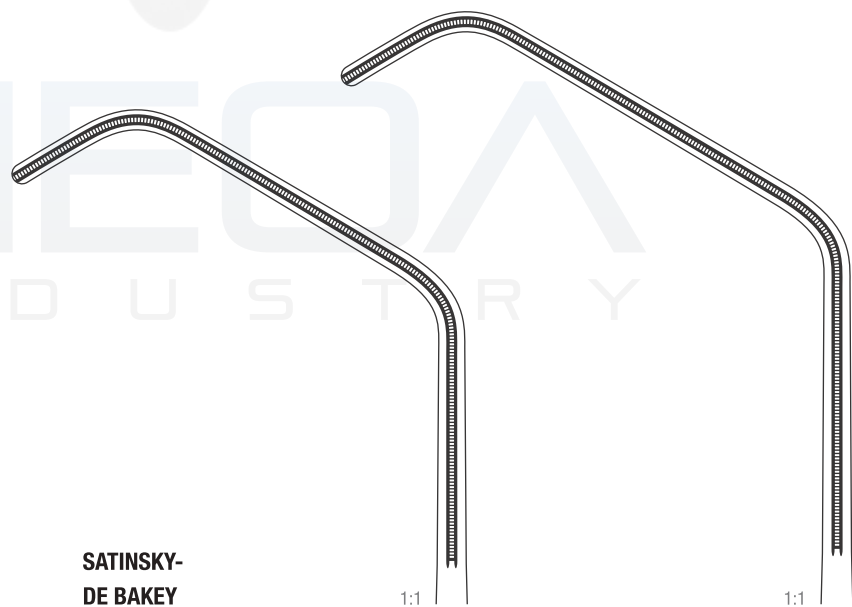

Atrauma	Atrauma
265 mm – 10 ½ "	275 mm – 10 ¾ "
05-207-260	05-207-270

Gefäßklemmen
Vascular forceps

Pinces vasculaires
Pinzas vasculares
Pinze vascolari

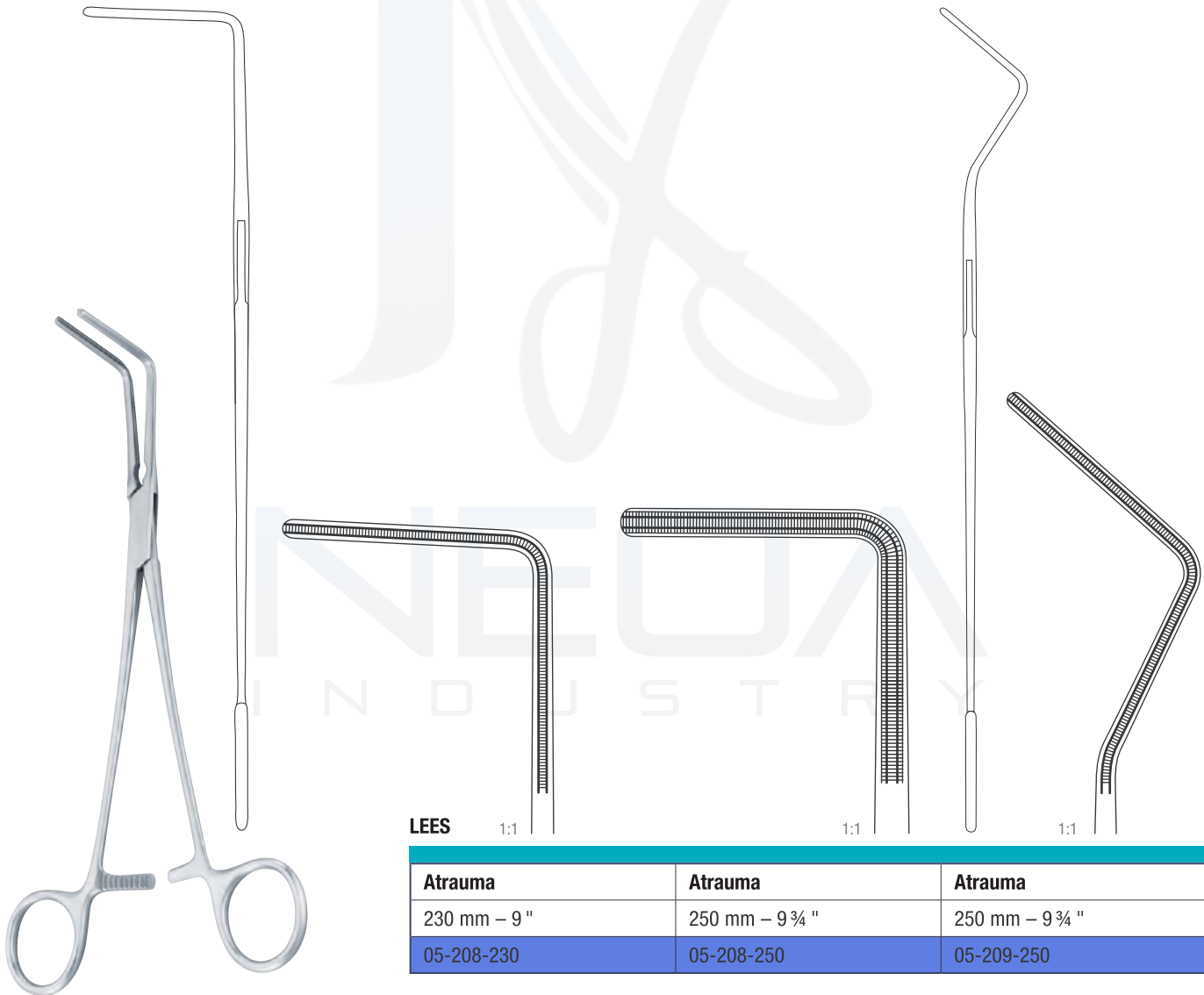

LEES

1:1

1:1

1:1

Atrauma	Atrauma	Atrauma
230 mm – 9 "	250 mm – 9 ¾ "	250 mm – 9 ¾ "
05-208-230	05-208-250	05-209-250

Gefäßklemmen
Vascular forceps

Pinces vasculaires
Pinzas vasculares
Pinze vascolari

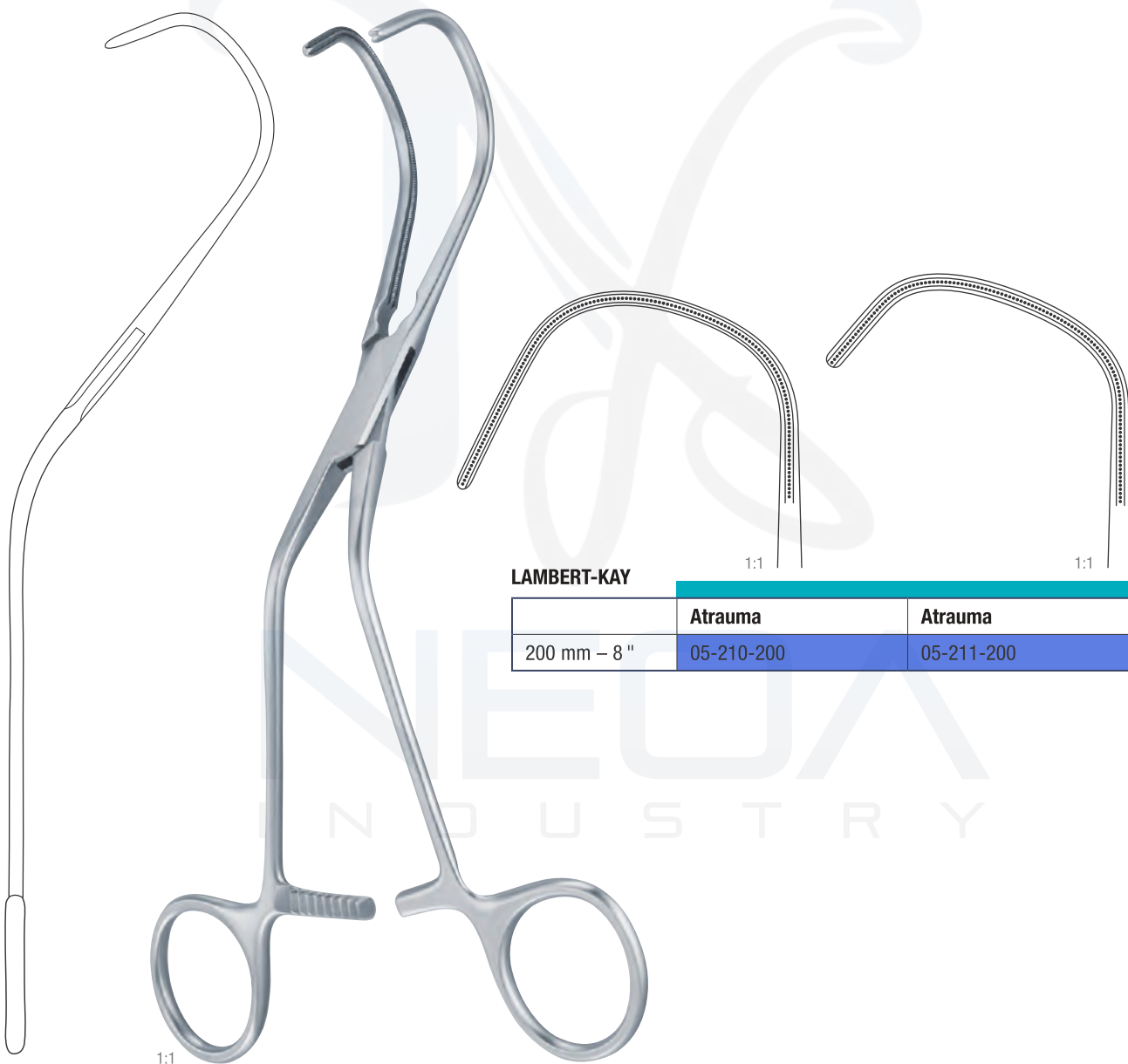

LAMBERT-KAY

	Atrauma	Atrauma
200 mm – 8"	05-210-200	05-211-200

Gefäßklemmen
Vascular forceps

Pinces vasculaires
Pinzas vasculares
Pinze vascolari

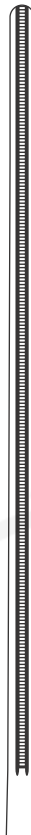
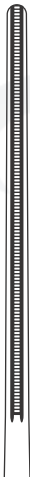

DE BAKEY

1:1

1:1

1:1

1:1

Atrauma	Atrauma	Atrauma	Atrauma
215 mm – 8 ½ "	230 mm – 9 "	270 mm – 10 ¾ "	315 mm – 12 ½ "
05-212-210	05-212-230	05-212-270	05-212-310

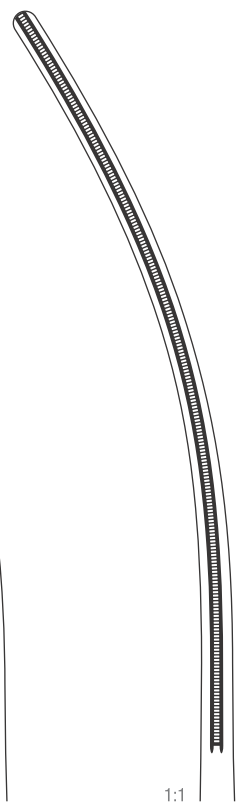
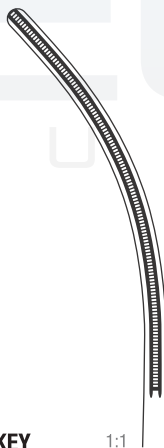

DE BAKEY

1:1

1:1

1:1

1:1

Atrauma	Atrauma	Atrauma	Atrauma
215 mm – 8 ½ "	230 mm – 9 "	270 mm – 10 ¾ "	315 mm – 12 ½ "
05-213-210	05-213-230	05-213-270	05-213-310

Gefäßklemmen
Vascular forceps

Pinces vasculaires
Pinzas vasculares
Pinze vascolari

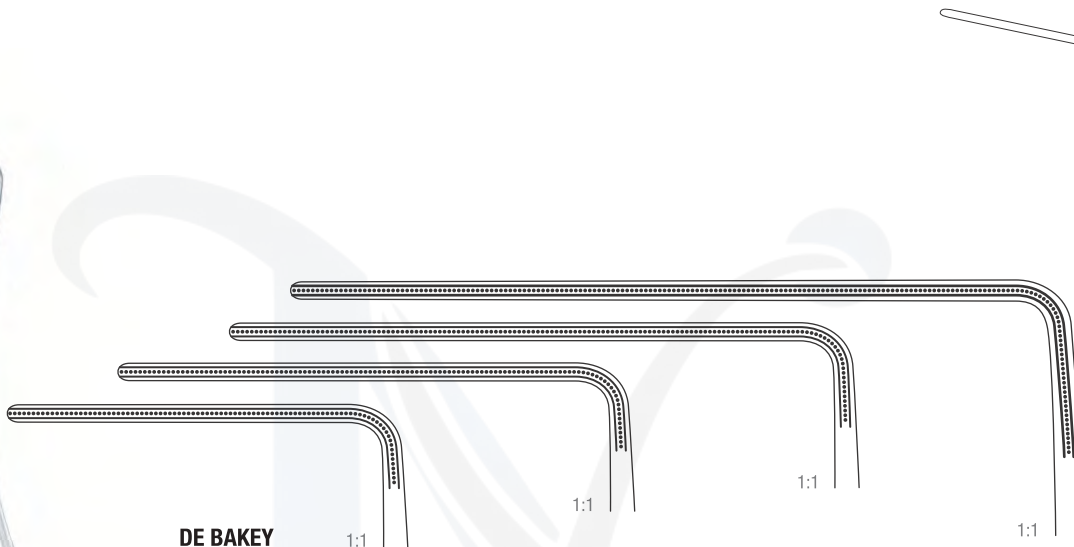

DE BAKEY

Atrauma	Atrauma	Atrauma	Atrauma
180 mm – 7 "	190 mm – 7 ½ "	230 mm – 9 "	270 mm – 10 ¾ "
05-214-180	05-214-190	05-214-230	05-214-270



DE BAKEY

Atrauma	Atrauma	Atrauma	Atrauma
200 mm – 8 "	210 mm – 8 ¼ "	250 mm – 9 ¾ "	300 mm – 12 "
05-215-200	05-215-210	05-215-250	05-215-300

Gefäßklemmen
Vascular forceps

Pinces vasculaires
Pinzas vasculares
Pinze vascolari

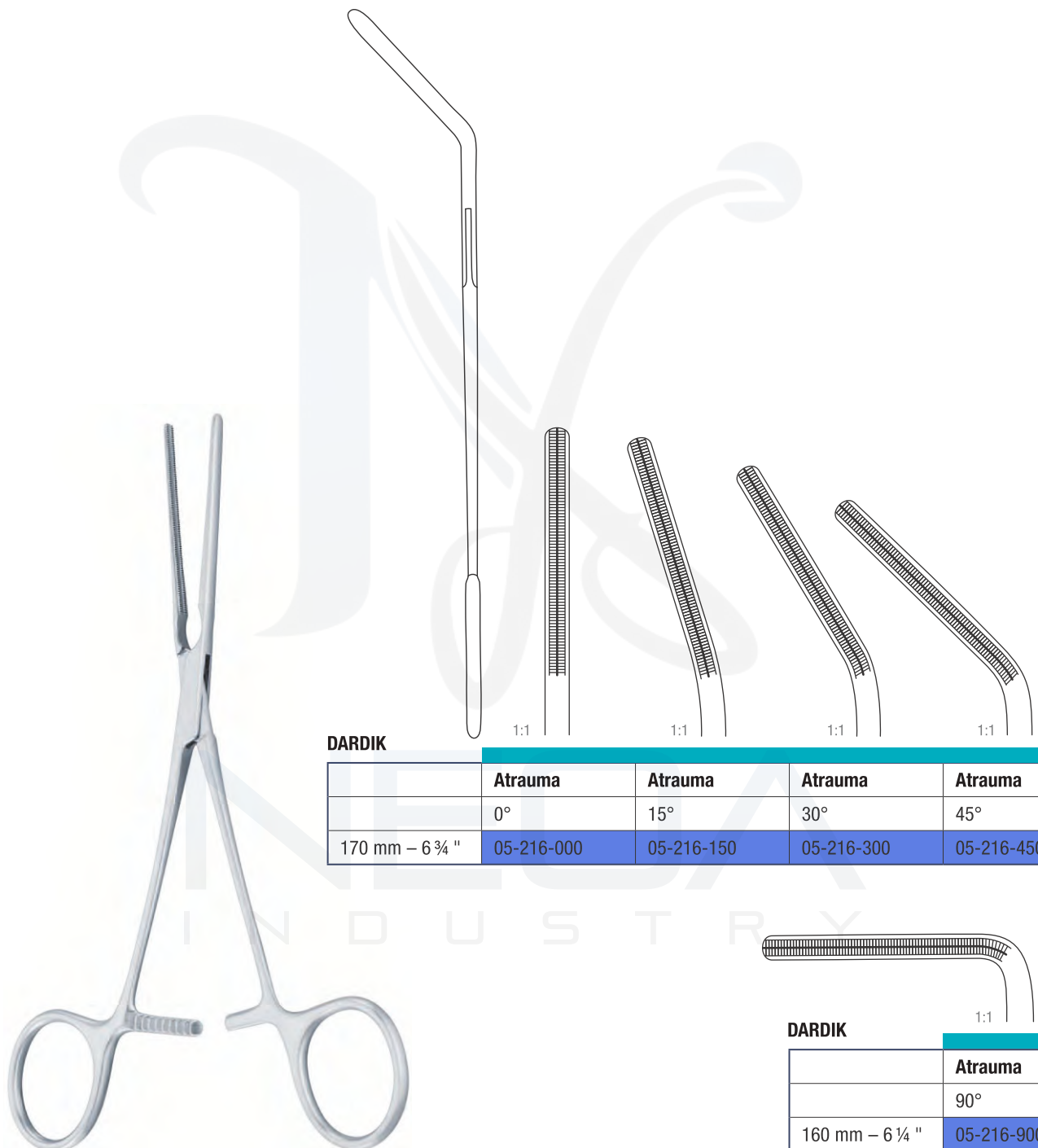

DARDIK

	Atrauma	Atrauma	Atrauma	Atrauma
	0°	15°	30°	45°
170 mm – 6 ¾ "	05-216-000	05-216-150	05-216-300	05-216-450

DARDIK

	Atrauma
	90°
160 mm – 6 ¼ "	05-216-900

Gefäßklemmen
Vascular forceps

Pinces vasculaires
Pinzas vasculares
Pinze vascolari



CHSNER

1:1

	Atrauma
235 mm – 9 ¼ "	05-217-230

1:2



DIETHRICH

1:1

	Atrauma
210 mm – 8 ¼ "	05-218-210

1:2

Gefäßklemmen
Vascular forceps

Pinces vasculaires
Pinzas vasculares
Pinze vascolari

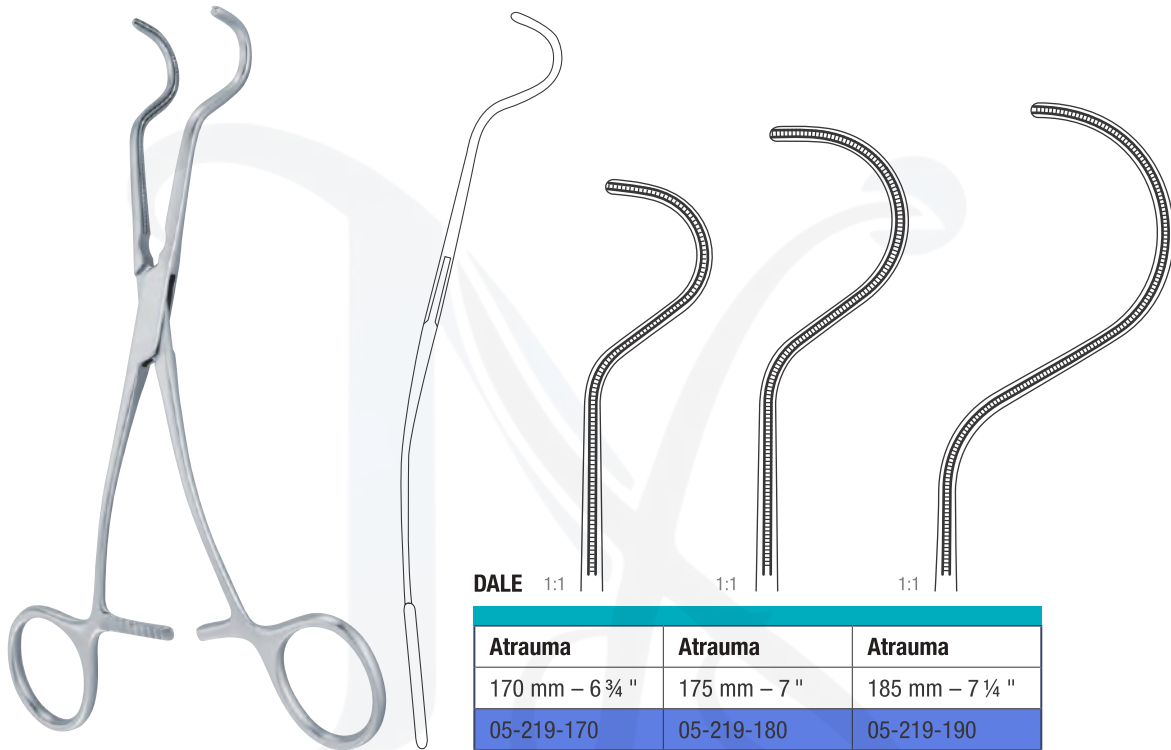

Atrauma	Atrauma	Atrauma
170 mm – 6 ¾ "	175 mm – 7 "	185 mm – 7 ¼ "
05-219-170	05-219-180	05-219-190

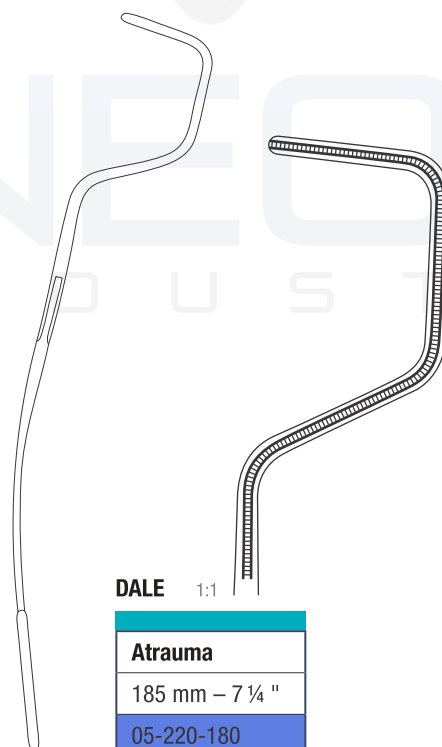

Atrauma
185 mm – 7 ¼ "
05-220-180

Gefäßklemmen
Vascular forceps

Pinces vasculaires
Pinzas vasculares
Pinze vascolari

TC



DE BAKEY-
WYLIE

1:1

1:1

Atrauma	Atrauma
160 mm – 6 ¼ "	180 mm – 7 "
05-221-160	05-221-180

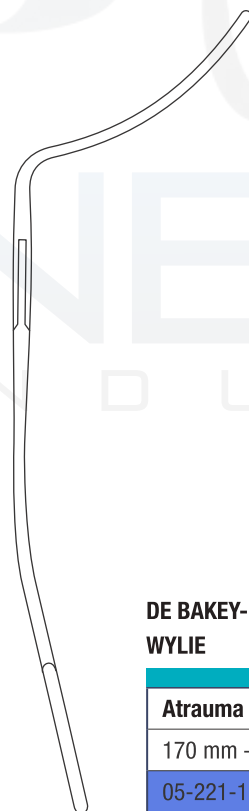

DE BAKEY-
WYLIE

1:1

1:1

Atrauma	Atrauma
170 mm – 6 ¾ "	200 mm – 8 "
05-221-170	05-221-200

Gefäßklemmen
Vascular forceps

Pinces vasculaires
Pinzas vasculares
Pinze vascolari

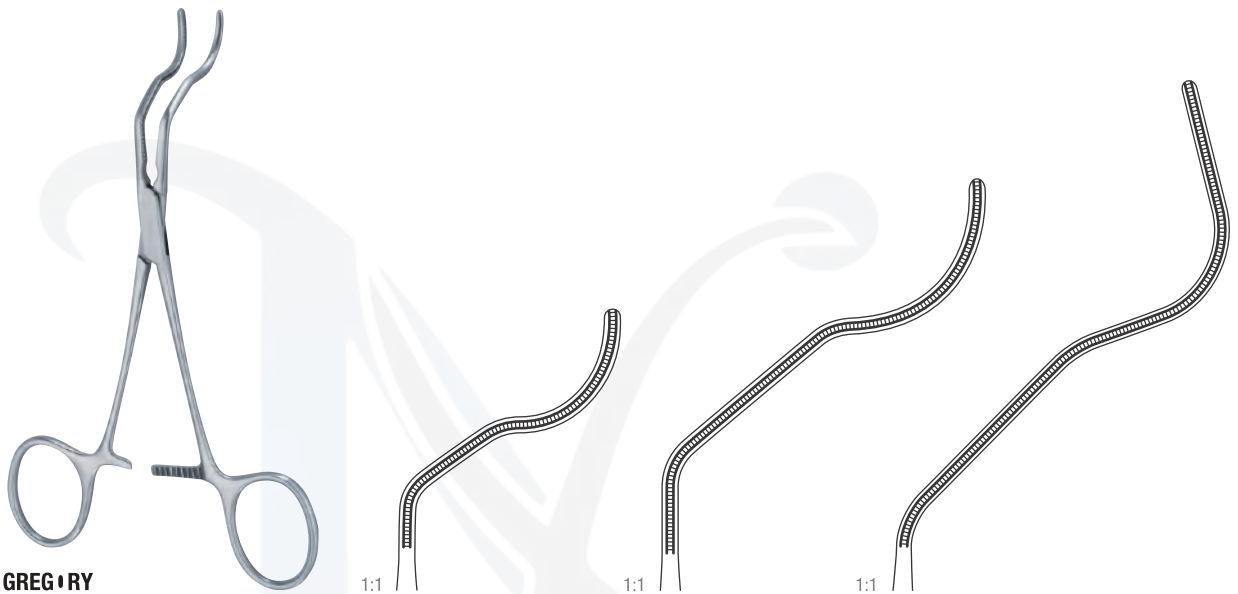

GREG•RY

Atrauma	Atrauma	Atrauma
140 mm – 5 ½ "	160 mm – 6 ¼ "	180 mm – 7 "
05-222-140	05-222-160	05-222-180

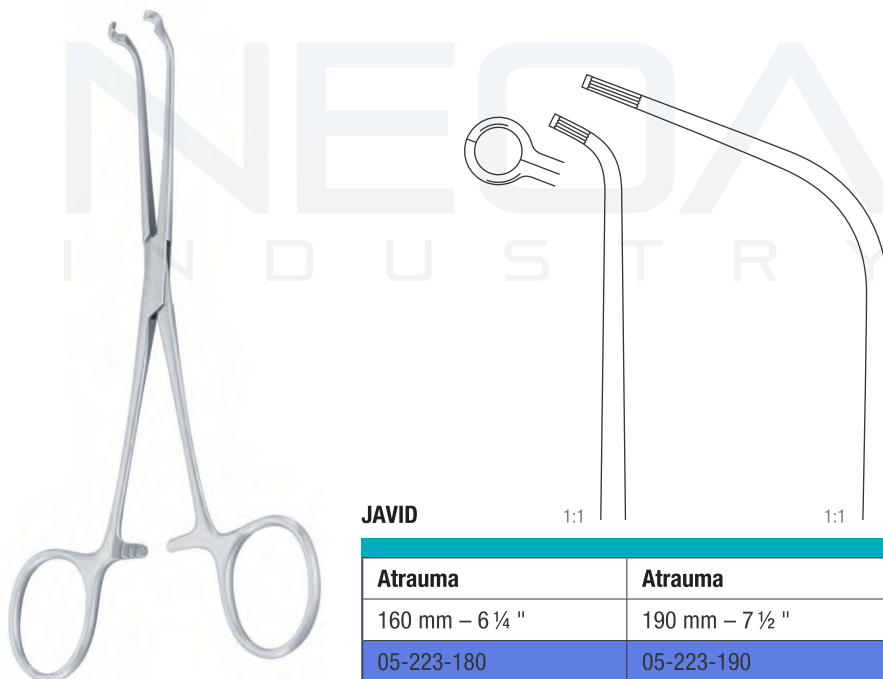

JAVID

Atrauma	Atrauma
160 mm – 6 ¼ "	190 mm – 7 ½ "
05-223-180	05-223-190

Gefäßklemmen Vascular forceps

Pinces vasculaires
Pinzas vasculares
Pinze vascolari

TC

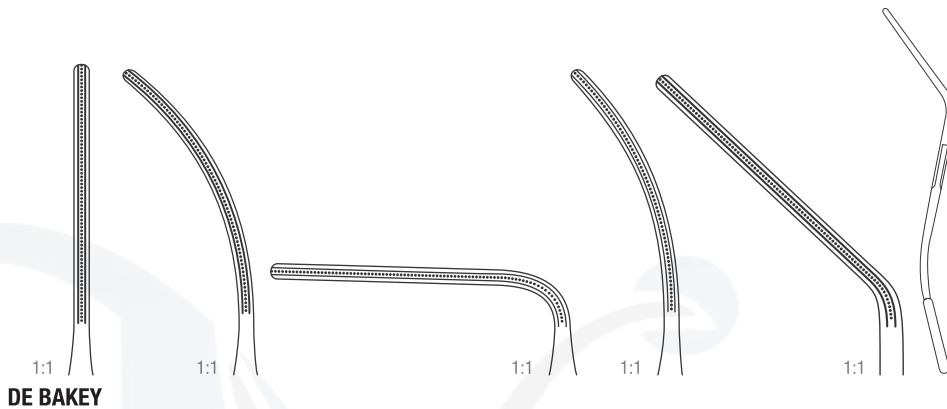

DE BAKHEY

Atrauma	Atrauma	Atrauma	Atrauma	Atrauma
120 mm – 4 ¾ "	110 mm – 4 ¼ "	100 mm – 4 "	120 mm – 4 ¾ "	130 mm – 5 "
313-098-120	313-099-120	313-109-120	313-117-120	313-107-120

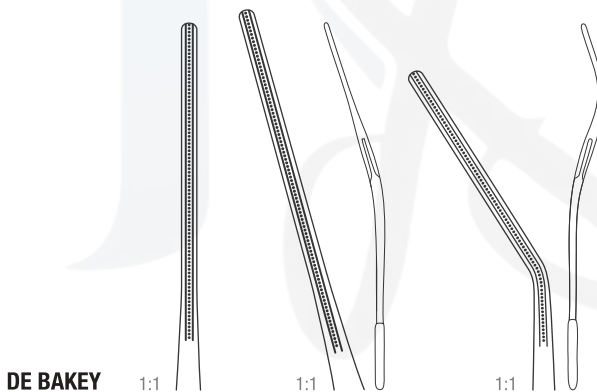

DE BAKHEY

Atrauma	Atrauma	Atrauma
170 mm – 6 ¾ "	170 mm – 6 ¾ "	160 mm – 6 ¼ "
05-225-170	05-224-170	05-226-160

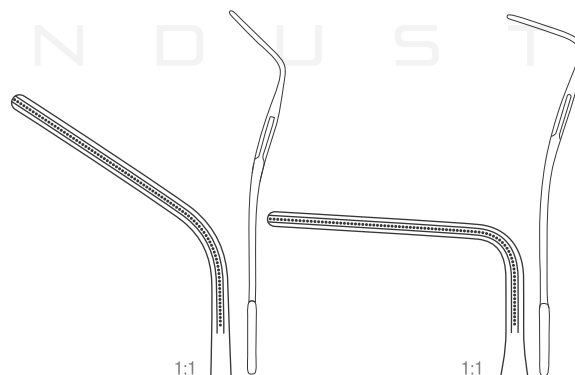

Atrauma	Atrauma
150 mm – 6 "	140 mm – 5 ½ "
05-226-150	05-226-140

Gefäßklemmen
Vascular forceps

Pinces vasculaires
Pinzas vasculares
Pinze vascolari



GL • VER

1:1



1:1



1:1



Atrauma	Atrauma	Atrauma
205 mm – 8 "	220 mm – 8 ¾ "	260 mm – 10 ¼ "
05-183-205	05-183-225	05-183-260

NEOA
INDUSTRY

GL • VER

1:1



1:1



1:1



Atrauma	Atrauma	Atrauma
205 mm – 8 "	220 mm – 8 ¾ "	260 mm – 10 ¼ "
05-227-210	05-184-225	05-184-260

abgewinkelt
angled on flat
coudée sur le plat
angulado
angolato

abgewinkelt
angled on flat
coudée sur le plat
angulado
angolato

abgewinkelt
angled on flat
coudée sur le plat
angulado
angolato

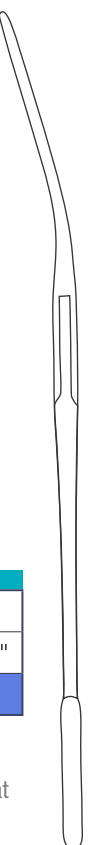

Gefäßklemmen
Vascular forceps

Pinces vasculaires
Pinzas vasculares
Pinze vascolari



GL • VER

Atrauma	Atrauma	Atrauma
170 mm – 6 ¾ "	210 mm – 8 ¼ "	240 mm – 9 ½ "
05-228-170	05-228-210	05-228-240

GL • VER

Atrauma	Atrauma
185 mm – 7 ¼ "	220 mm – 8 ¾ "
05-229-180	05-229-220

Gefäßklemmen
Vascular forceps

Pinces vasculaires
Pinzas vasculares
Pinze vascolari

TC

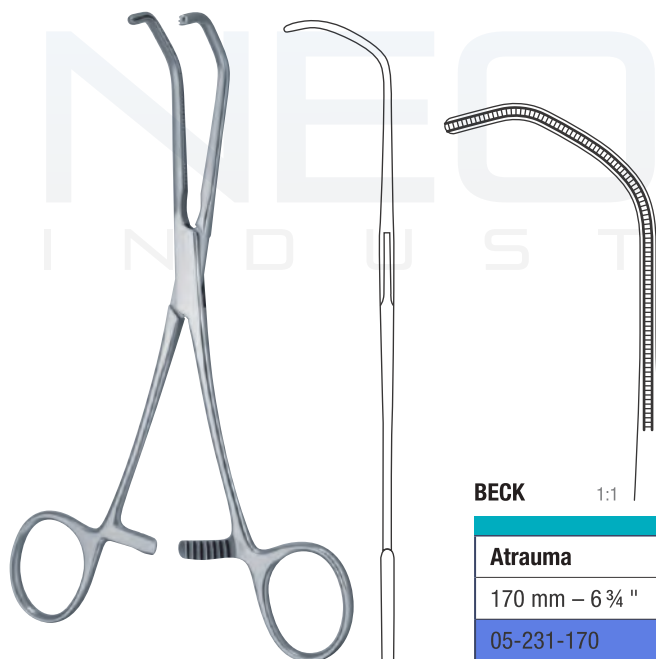
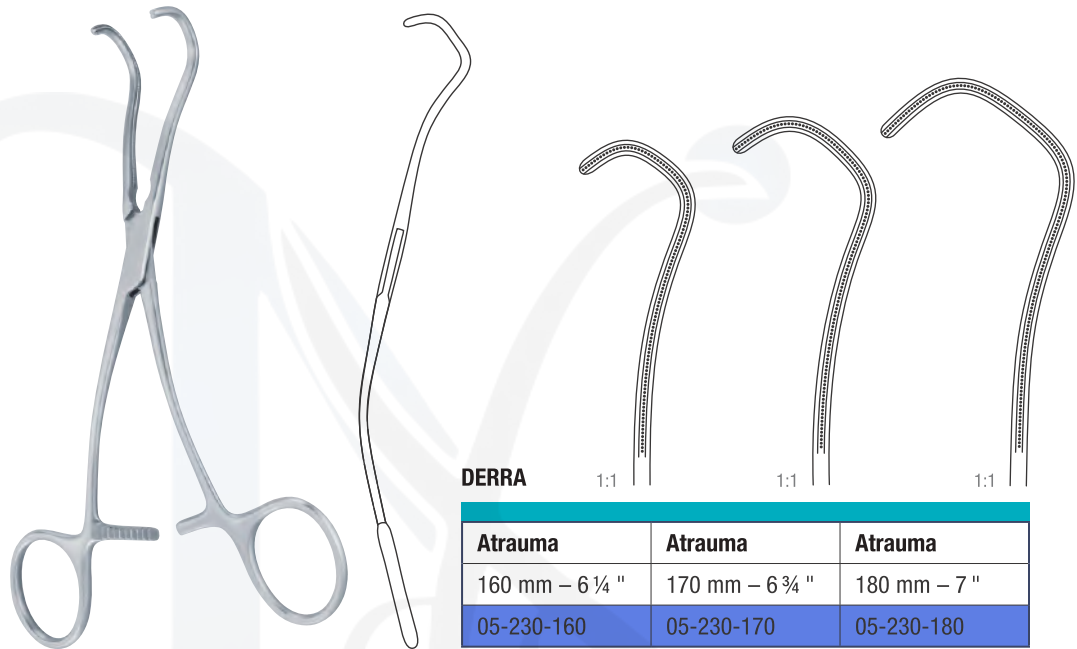

Neonatal- u. Kinderklemmen, extra feine modelle
Neonatal and children's clamps, extra delicate patterns

Pinces pour nouveaux-nés et enfants, modèles très fins
Pinzas para recién nacidos y niños, modelos muy finos
Pinze per bambini e neonati, molto fine

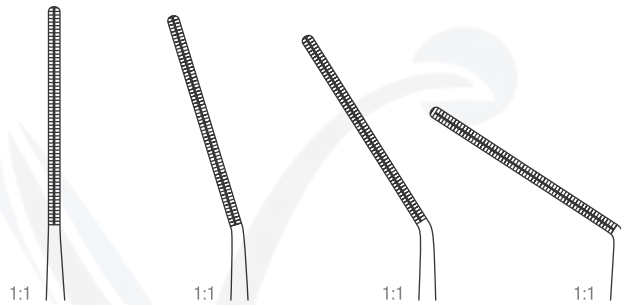

	Atrauma	Atrauma	Atrauma	Atrauma
	Fig. 1	Fig. 2	Fig. 3	Fig. 4
115 mm – 4 ½ "	05-232-010	05-232-020	05-232-030	05-232-040
145 mm – 5 ¾ "	05-233-010	05-233-020	05-233-030	05-233-040

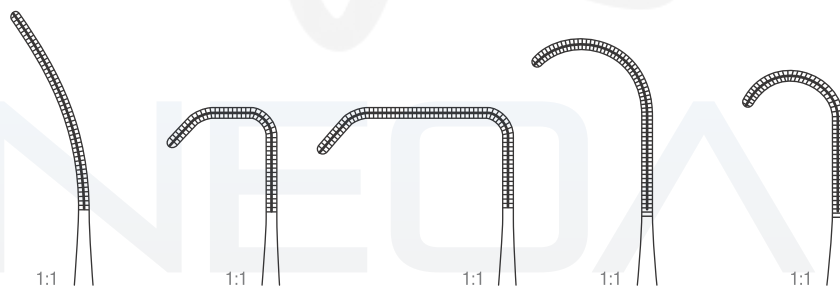

	Atrauma	Atrauma	Atrauma	Atrauma	Atrauma
	Fig. 5	Fig. 6	Fig. 7	Fig. 8	Fig. 9
115 mm – 4 ½ "	05-232-050	05-232-060	05-232-070	05-232-080	05-232-090
145 mm – 5 ¾ "	05-233-050	05-233-060	05-233-070	05-233-080	05-233-090

Neonatal- u. Kinderklemmen, extra feine modelle
Neonatal and children's clamps, extra delicate patterns

Pinces pour nouveaux-nés et enfants, modèles très fins
Pinzas para recién nacidos y niños, modelos muy finos
Pinze per bambini e neonati, molto fine

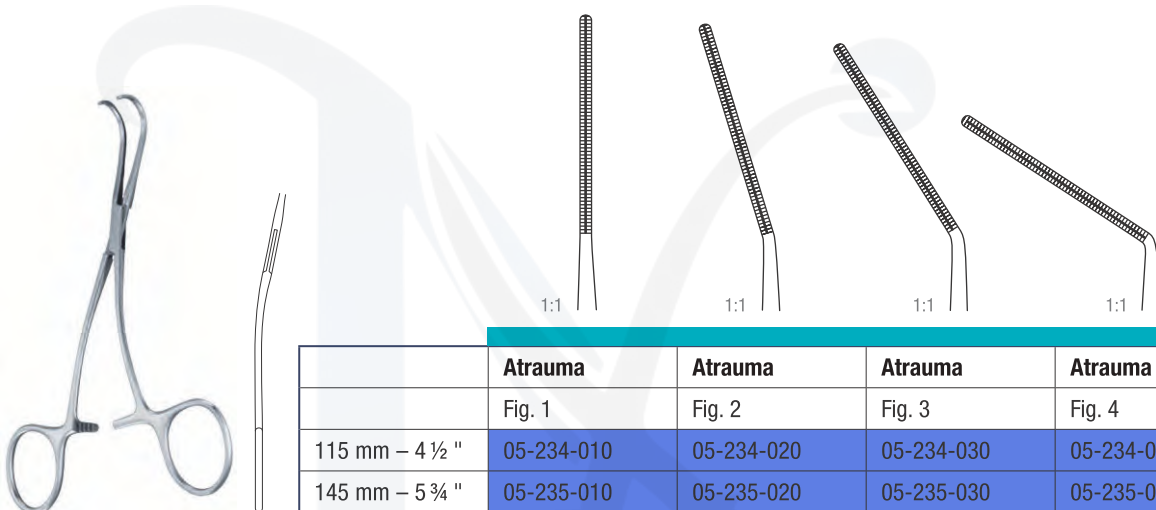

	Atrauma	Atrauma	Atrauma	Atrauma
	Fig. 1	Fig. 2	Fig. 3	Fig. 4
115 mm – 4 ½ "	05-234-010	05-234-020	05-234-030	05-234-040
145 mm – 5 ¾ "	05-235-010	05-235-020	05-235-030	05-235-040

gebogen
 curved
 courbe
 curva
 curve

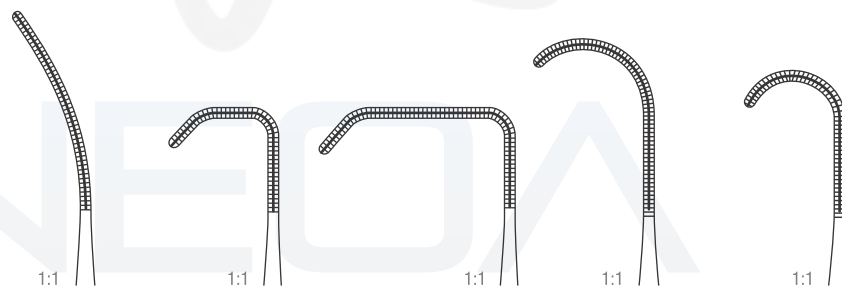

	Atrauma	Atrauma	Atrauma	Atrauma	Atrauma
	Fig. 5	Fig. 6	Fig. 7	Fig. 8	Fig. 9
115 mm – 4 ½ "	05-234-050	05-234-060	05-234-070	05-234-080	05-234-090
145 mm – 5 ¾ "	05-235-050	05-235-060	05-235-070	05-235-080	05-235-090

Neonatal- u. Kinderklemmen, extra feine modelle
Neonatal and children's clamps, extra delicate patterns

Pinces pour nouveaux-nés et enfants, modèles très fins
Pinzas para recién nacidos y niños, modelos muy finos
Pinze per bambini e neonati, molto fine

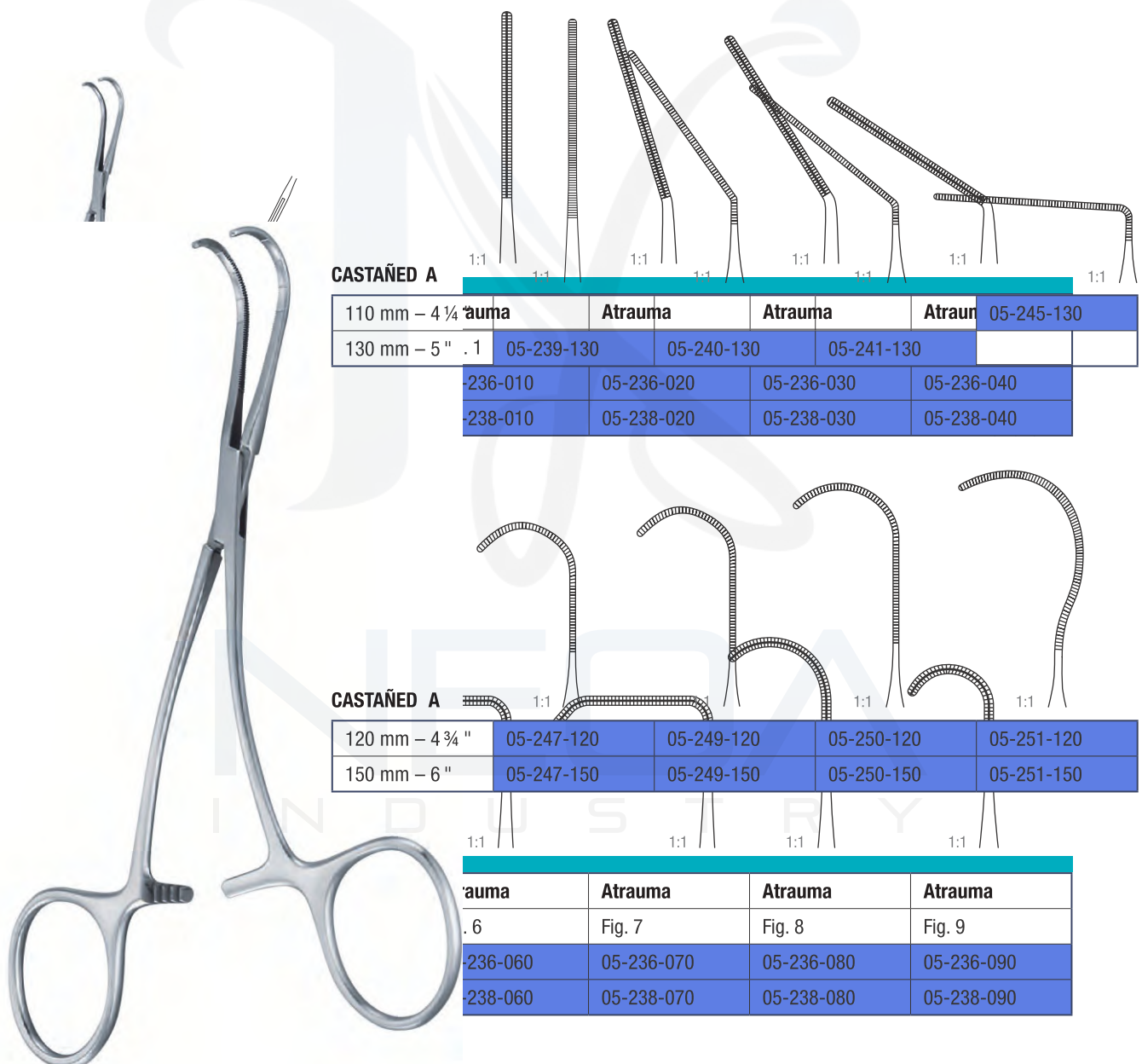

CASTAÑED A

110 mm – 4 ¼ " .6	Atrauma	Atrauma	Atrauma	Atrauma	05-245-130
130 mm – 5 " .1	05-239-130	05-240-130	05-241-130		
	236-010	05-236-020	05-236-030	05-236-040	
	238-010	05-238-020	05-238-030	05-238-040	

CASTAÑED A

120 mm – 4 ¾ " .6	05-247-120	05-249-120	05-250-120	05-251-120
150 mm – 6 " .1	05-247-150	05-249-150	05-250-150	05-251-150

Atrauma	Atrauma	Atrauma	Atrauma
.6	Fig. 7	Fig. 8	Fig. 9
236-060	05-236-070	05-236-080	05-236-090
238-060	05-238-070	05-238-080	05-238-090

Gefäßklemmen Vascular forceps

Pinces vasculaires
Pinzas vasculares
Pinze vascolari

TC



COLEY

	Atrauma	Atrauma	Atrauma
120 mm – 4 3/4 "	05-252-120	05-253-120	05-254-120
	gerade straight droit recta retta	gebogen curved courbe curva curva	S-förmig gebogen S-curved courbe en S curva en S curva a forma S

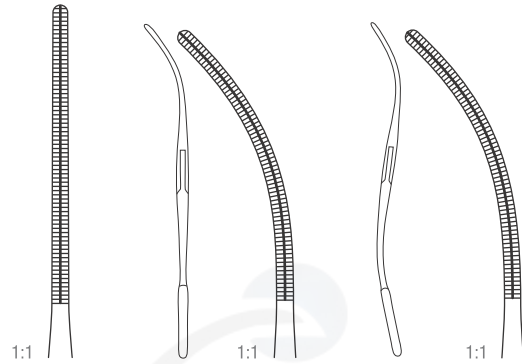

COLEY

	Atrauma	Atrauma	Atrauma
120 mm – 4 3/4 "	05-255-120	05-256-120	05-257-120
	seitlich abgewinkelt sidewards angled coudé vers la coté angulado al lado angolata lateralmente	abgewinkelt angled on flat coudé sur le plat angulado angolato	90° abgewinkelt 90° angled on flat 90° coudé sur le plat 90° angulado 90° angolato

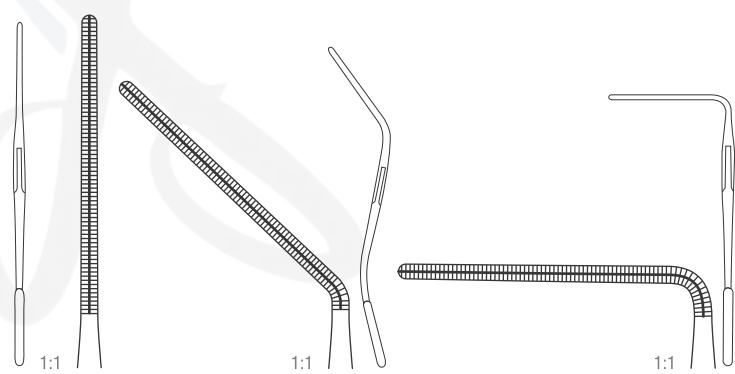

COLEY

Atrauma
170 mm – 6 3/4 "
05-258-170

seitlich abgewinkelt
sidewards angled
coudé vers la coté
angulado al lado
angolata lateralmente

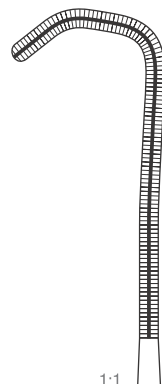

Gefäßklemmen
Vascular forceps

Pinces vasculaires
Pinzas vasculares
Pinze vascolari

TC

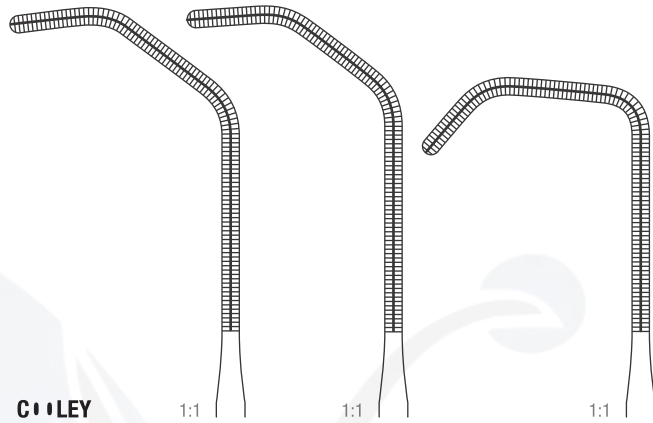

C • OLEY

Atrauma	Atrauma	Atrauma
175 mm – 7 "	175 mm – 7 "	165 mm – 6 ½ "
05-259-175	05-260-210	05-261-001

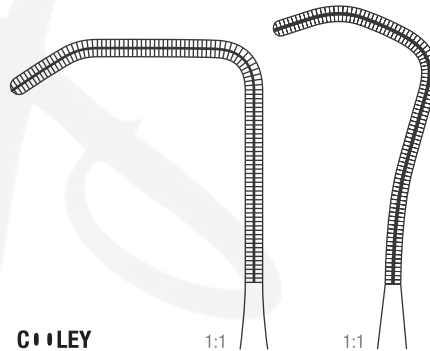

C • OLEY

Atrauma	Atrauma
165 mm – 6 ½ "	170 mm – 6 ¾ "
05-261-002	05-262-170

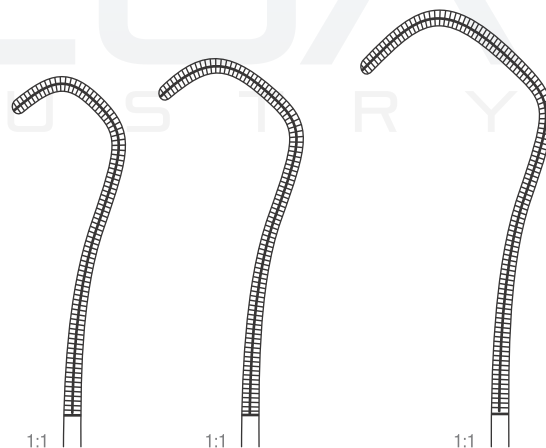

C • OLEY-
DERRA

Atrauma	Atrauma	Atrauma
165 mm – 6 ½ "	170 mm – 6 ¾ "	175 mm – 7 "
05-263-160	05-263-170	05-263-180

Gefäßklemmen
Vascular forceps

Pinces vasculaires
Pinzas vasculares
Pinze vascolari



**C••LEY-
 BECK**

1:1

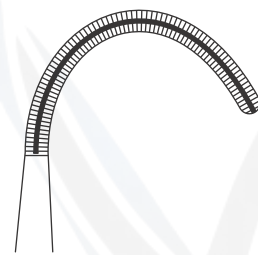

1:1

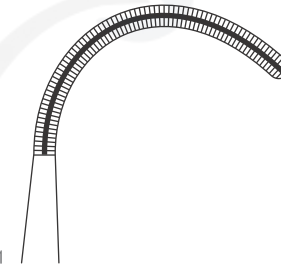

Atrauma	Atrauma
150 mm – 6 "	155 mm – 6 "
05-264-150	05-264-155



C••LEY

1:1

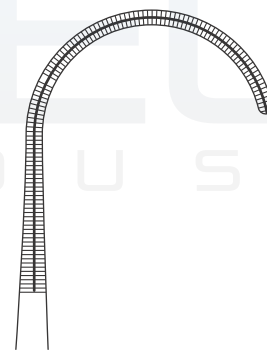

1:1

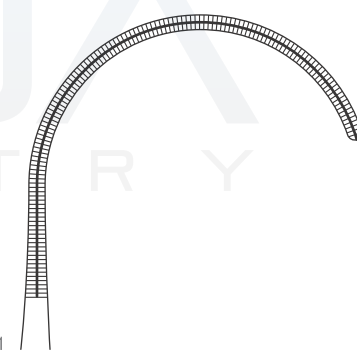

Atrauma	Atrauma
150 mm – 6 "	160 mm – 6 ¼ "
05-265-150	05-265-160

Gefäßklemmen
Vascular forceps

Pinces vasculaires
Pinzas vasculares
Pinze vascolari



CILLEY

1:1

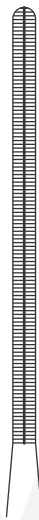

1:1



Atrauma	Atrauma
210 mm – 8 ¼ "	250 mm – 9 ¾ "
05-266-215	05-266-250

seitwärts abgewinkelt
sidewards angled on flat
coudé vers la coté
angulado al lado
angolata lateralmente

seitwärts abgewinkelt
sidewards angled on flat
coudé vers la coté
angulado al lado
angolata lateralmente



CILLEY

1:1



1:1

Atrauma	Atrauma
180 mm – 7 "	185 mm – 7 ¼ "
05-267-180	05-268-185

gerade
straight
droit
recta
retta

abgewinkelt
angled on flat
coudé sur le plat
angulado
angolato

Gefäßklemmen
Vascular forceps

Pinces vasculaires
Pinzas vasculares
Pinze vascolari

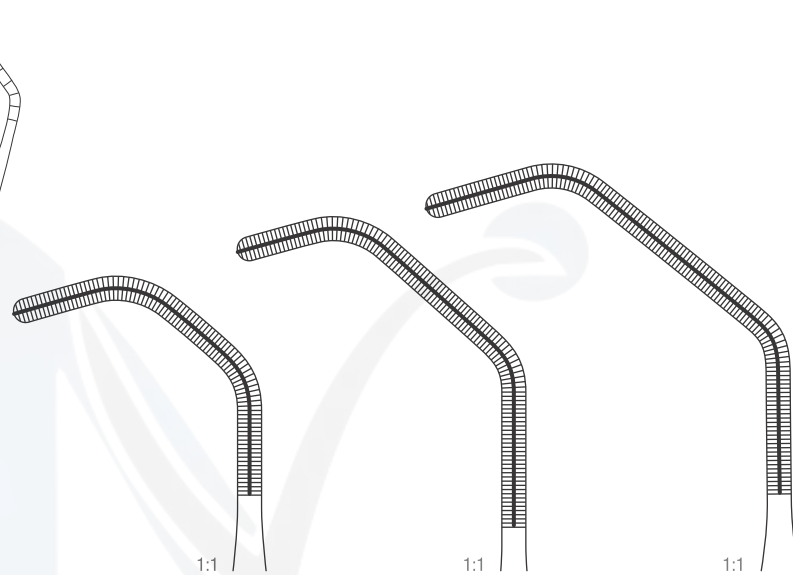

C • LEY-TANGENTIAL

Atrauma	Atrauma	Atrauma
195 mm – 7 ¾ "	255 mm – 10 "	260 mm – 10 ¼ "
05-260-195	05-260-255	05-260-260

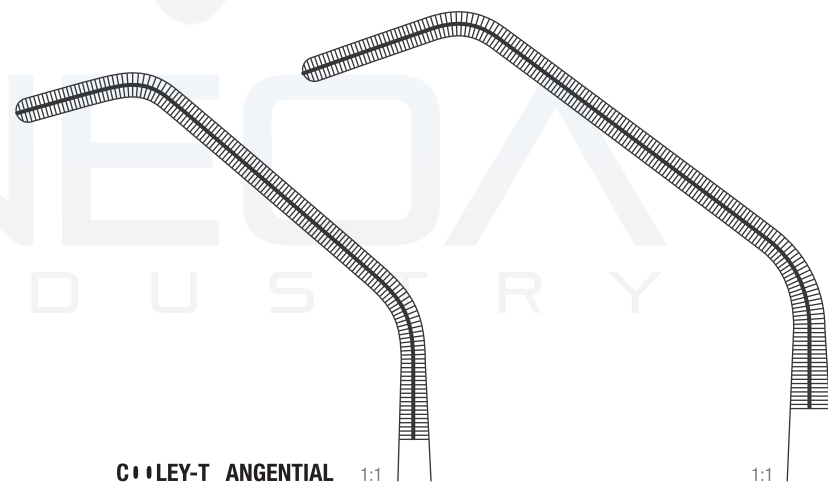

C • LEY-T ANGENTIAL

Atrauma	Atrauma
265 mm – 10 ½ "	270 mm – 10 ¾ "
05-260-265	05-260-270

Mehrzweckklemmen, pädiatrisch, graduiert
Multi-purpose clamps, pediatric, graduated

Pinces polyvalentes, pédiatriques, graduées
Pinzas de uso vario, pediátricas, graduadas
Pinze multi uso, per bambini, graduati

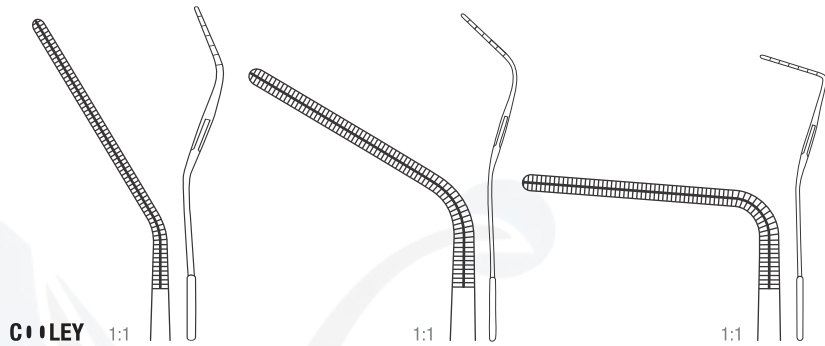

Atrauma	Atrauma	Atrauma
25°	45°	90°
165 mm – 6 ½ "	160 mm – 6 ¼ "	145 mm – 5 ¾ "
05-269-250	05-269-450	05-269-900

CILEY
PATENT DUCTUS CLAMP



160 mm – 6 ¼ "	05-267-170	05-266-160
170 mm – 6 ¾ "	05-270-170	05-271-170
200 mm – 8 "	05-267-200	05-266-210
230 mm – 9 "	05-267-230	05-266-230
250 mm – 10 "		05-266-250

abgewinkelt, graduiert
 angled on flat, graduated
 coudée sur le plat, graduée
 angulada, graduada
 angolata, graduata

Mehrzweckklemmen, pädiatrisch, graduert
Multi-purpose clamps, pediatric, graduated

Pinces polyvalentes, pédiatriques, graduées
Pinzas de uso vario, pediátricas, graduadas
Pinze multi uso, per bambini, graduati

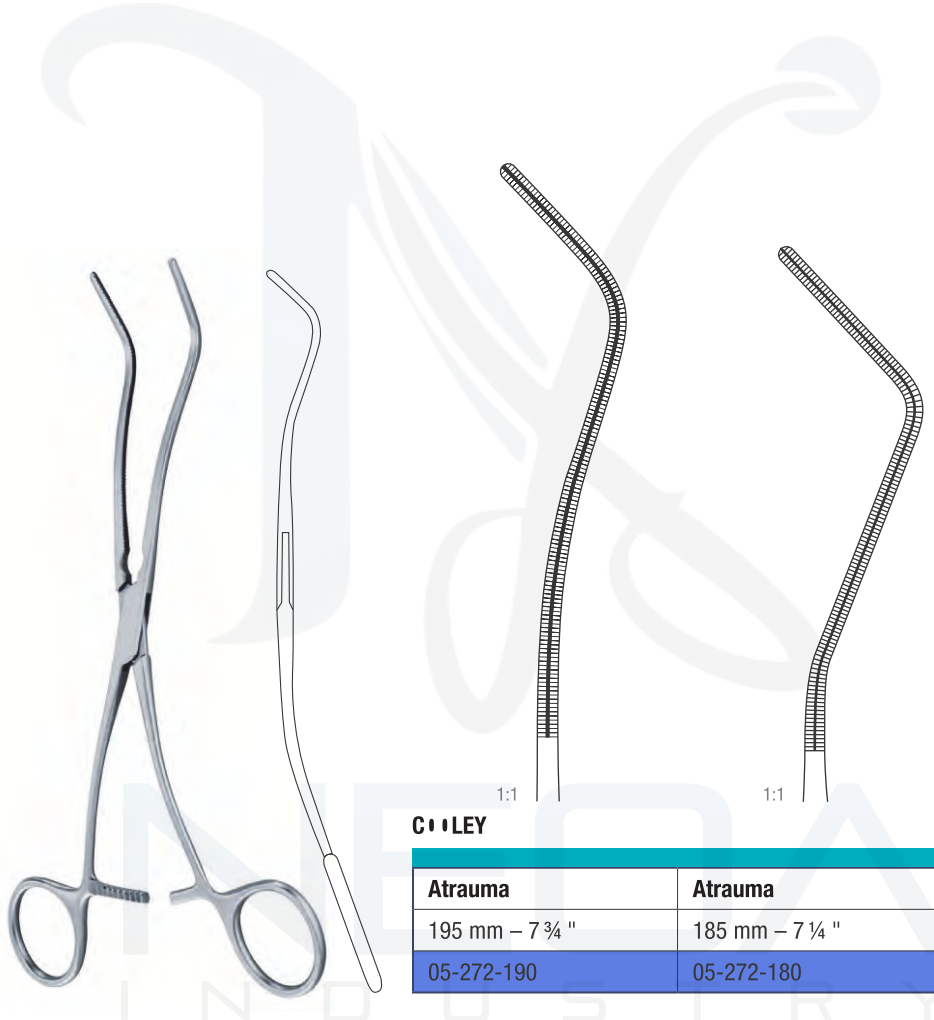

C••LEY

Atrauma	Atrauma
195 mm – 7 ¾ "	185 mm – 7 ¼ "
05-272-190	05-272-180

Mehrzweckklemmen
Multi-purpose clamps

Pinces clamps polyvalentes
Pinzas clamps para usos varios
Pinze multi uso



C••LEY

Atrauma	Atrauma
265 mm – 10 ½ "	335 mm – 13 ¼ "
05-273-265	05-273-335

C••LEY

Atrauma

315 mm – 12 ½ "

05-274-315

S-förmig gebogen
S-curved
courbe en S
curva en S
curva a forma S

Gefäß-Dilatatoren

Vascular dilators

Dilatateurs vasculaires
Dilatadores vasculares
Dilatatori vascolari

DE BAKEY

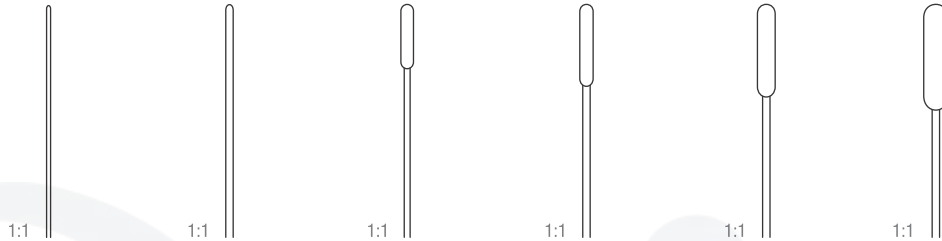

	0.5 mm Ø	1.0 mm Ø	1.5 mm Ø	2.0 mm Ø	2.5 mm Ø	3.0 mm Ø
190 mm – 7 ½ "	05-275-050	05-275-100	05-275-150	05-275-200	05-275-250	05-275-300
350 mm – 13 ¾ "	05-276-050	05-276-100	05-276-150	05-276-200	05-276-250	05-276-300

biegsam
 malleable
 malléable
 maleable
 flessibile

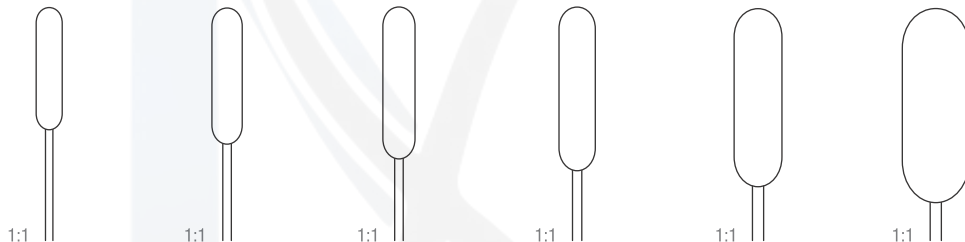

	3.5 mm Ø	4.0 mm Ø	4.5 mm Ø	5.0 mm Ø	7.0 mm Ø	9.0 mm Ø
190 mm – 7 ½ "	05-275-350	05-275-400	05-275-450	05-275-500	05-275-700	05-275-900
350 mm – 13 ¾ "	05-276-350	05-276-400	05-276-450	05-276-500	05-276-700	05-276-900

190 mm – 7 ½ "

05-275-000

Satz (12 Stück): 05-275-050 – 05-275-900
 Set (12 pieces): 05-275-050 – 05-275-900
 jeu (12 pièces): 05-275-050 – 05-275-900
 juego (12 piezas): 05-275-050 – 05-275-900
 serie (12 pezzi): 05-275-050 – 05-275-900

350 mm – 13 ¾ "

05-276-000

Satz (12 Stück): 05-276-050 – 05-276-900
 Set (12 pieces): 05-276-050 – 05-276-900
 jeu (12 pièces): 05-276-050 – 05-276-900
 juego (12 piezas): 05-276-050 – 05-276-900
 serie (12 pezzi): 05-276-050 – 05-276-900

Gefäß-Dilatatoren
Vascular dilators

Dilatateurs vasculaires
Dilatadores vasculares
Dilatatori vascolari

C•ILEY

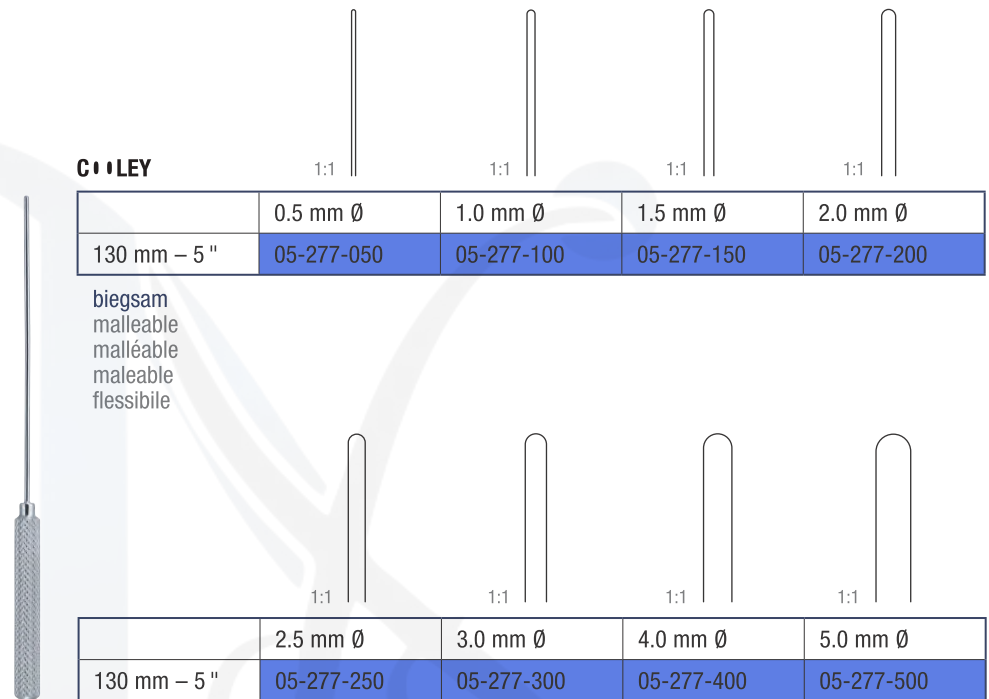

	0.5 mm Ø	1.0 mm Ø	1.5 mm Ø	2.0 mm Ø
130 mm – 5 "	05-277-050	05-277-100	05-277-150	05-277-200

biegsam
malleable
malléable
maleable
flessibile

	2.5 mm Ø	3.0 mm Ø	4.0 mm Ø	5.0 mm Ø
130 mm – 5 "	05-277-250	05-277-300	05-277-400	05-277-500

130 mm – 5 "	05-277-000
--------------	------------

Satz (8 Stück): 05-277-050 – 05-277-500
 Set (8 pieces): 05-277-050 – 05-277-500
 jeu (8 pièces): 05-277-050 – 05-277-500
 juego (8 piezas): 05-277-050 – 05-277-500
 serie (8 pezzi): 05-277-050 – 05-277-500

Aorta-Dilatatoren Aortic dilators

Dilatateurs aortiques
Dilatadores de aorta
Dilatori per aorta



1:2

TUBBS

05-278-450

für Erwachsene, Spreizweite 8 mm – 42 mm
for adults, blade opening from 8 mm – 42 mm
pour adultes, écartement de 8 mm – 42 mm
para adultos, apertura de 8 mm – 42 mm
per adulti, apertura da 8 mm – 42 mm

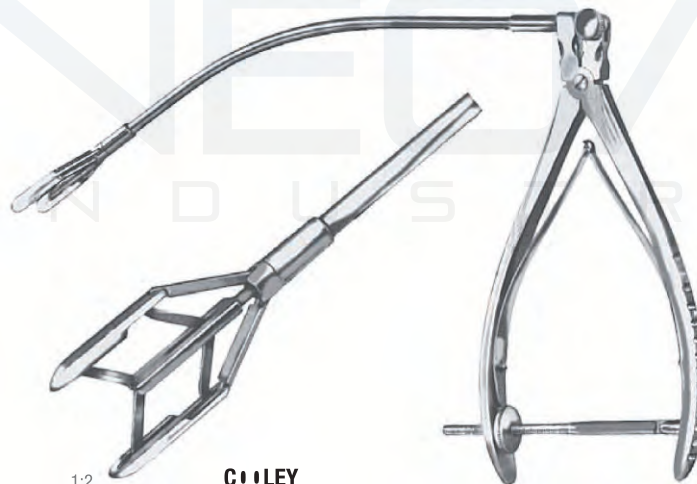

1:2

COILEY

05-279-150

für Kinder, Spreizweite 6 mm – 15 mm
for children, blade opening from 6 mm – 15 mm
pour enfants, écartement de 6 mm – 15 mm
para niños, apertura de 6 mm – 15 mm
per bambini, apertura da 6 mm – 15 mm

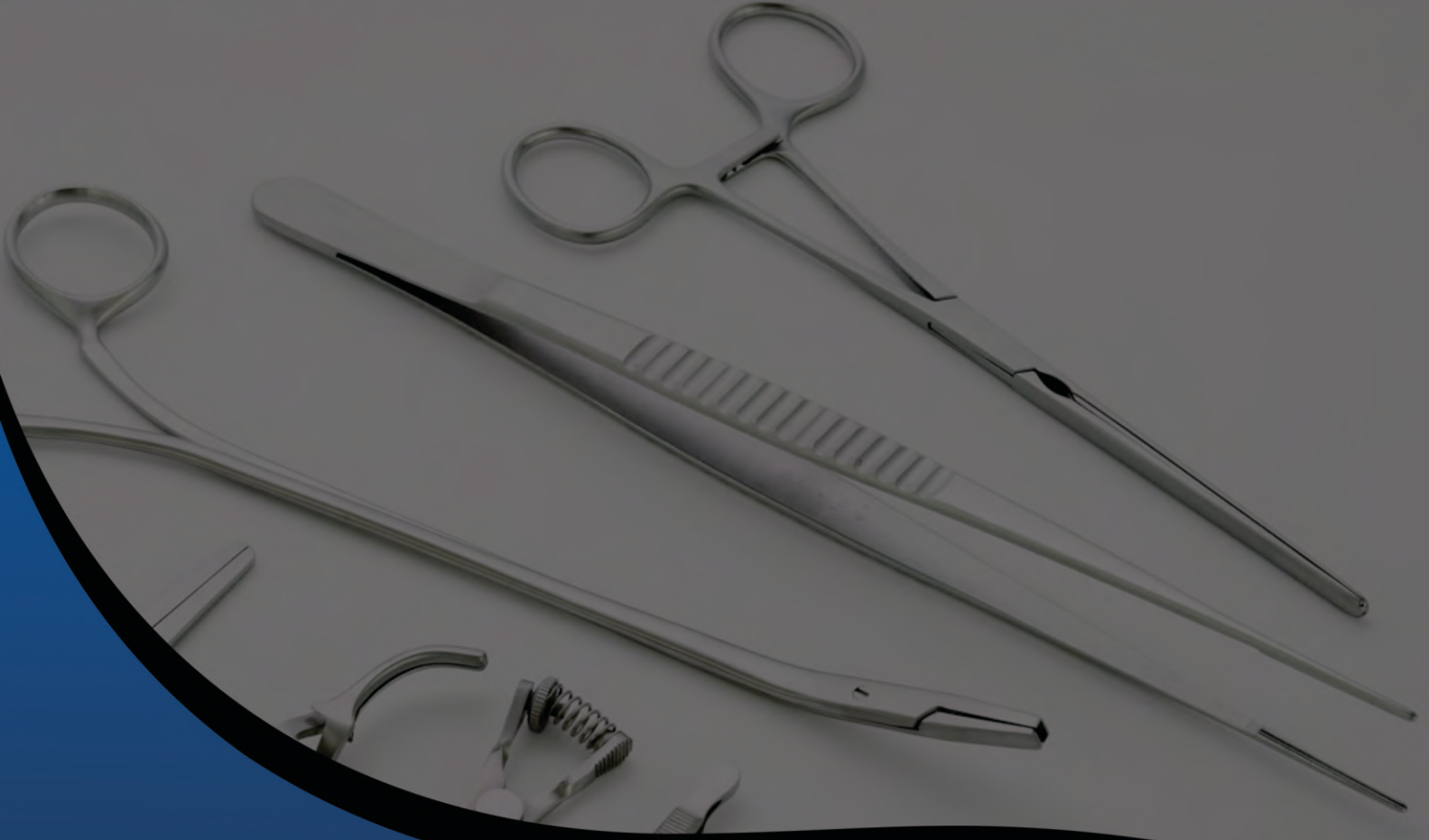

Manufacturer & Supplier Premium Quality Surgical, Dental, Podiatry, Pet Grooming and Beauty Care Instruments.

USA Address:

📍 5900 Balcones Drive # 16244
Austin TX, USA 78731.
☎ +1 (917) 773 3694
📞 **uk:** +44 7871 836765
✉ info@neoaindustry.com
neoaindustry4@gmail.com
🌐 www.neoaindustry.com

Main Head Office:

📍 Roars Road New Miana Pura
West, Sialkot 51310 Pakistan.
☎ +92 322 5587688
📞 +92 322 5587688
✉ info@neoaindustry.com
neoaindustry4@gmail.com
🌐 www.neoaindustry.com



ایمان مندی دھارت سیکوٹ

